

TABLE OF CONTENTS	
SHEET NO.	MATERIAL NUMBER
1	NOTES AND BOM
2	KEY CONFIGURATIONS
3	RECEPTACLE CONNECTOR ASSEMBLY

AWG	PART NUMBER	PAYOFF DIRECTION	PLATING	GRIP	OSR P/N	WIRE OD RANGE	COLOR
22	34083-2003	RIGHT	TN	22	E-1644-01	1.19-1.65	PNK
22	34083-3003	LEFT	TN	22			
22	34081-3005	LEFT	GOLD	22			
20	34083-2002	RIGHT	TN	18/20			
20	34083-3002	LEFT	TN	18/20			
20	34081-2004	RIGHT	GOLD	18/20	E-1644-00	1.60-2.10	GREEN
20	34081-3004	LEFT	GOLD	18/20			
18	34083-2002	RIGHT	TN	18/20			
18	34083-3002	LEFT	TN	18/20			
18	34081-2004	RIGHT	GOLD	18/20			
18	34081-3004	LEFT	GOLD	18/20			
16	34083-2001	RIGHT	TN	16			
16	34083-3001	LEFT	TN	16			
16	34081-2003	RIGHT	GOLD	16	E-1644-02	2.10-2.50	YELLOW
16	34081-3003	LEFT	GOLD	16			
WIRE SIZE						CABLE SEAL	
TERMINAL *PREFERRED* (SEE NOTE 5 FOR OPTIONAL TERMINALS)							
OSR) CABLE SEAL							

UNLESS OTHERWISE SPECIFIED:

- PART CONFORMS TO SAE/USCAR-2 REV. 4 (05/04), EXCEPT AS FOLLOWS:
- DESIGNED TO MATE WITH DEVICE CONNECTION AS SPECIFIED IN USCAR/EWCAP DRAWING NO 150-S-003-1-Z02, ALL OPTION A-D, REV A, DATED 10/19/99, ALSO WITH THE DEVICE CONNECTION AS SPECIFIED IN USCAR/EWCAP DRAWING NO 150-S-003-1-Z01, ALL OPTION A-D, REV D, DATED 10/15/02.
- ASSEMBLY SHIPPED WITH TPA IN PRE-LOCK POSITION (SEE SECTION A-A PRELOCK). UPON FULL TERMINAL ASSEMBLY, TPA MUST BE SNAPPED INTO ITS FINAL LOCK POSITION AFTER TERMINALS ARE ASSEMBLED.
- OPTIONAL CPA SHOWN IN ALL VIEWS. SEE TABLE FOR SPECIFIC ASSEMBLY OPTION AND NUMBER.
- FOR PREFERRED TERMINALS SEE MOLEX DRAWING SD-34083-002 FOR OPTIONAL TERMINALS SEE MOLEX DRAWING SD-34083-001

LATCH STYLE	P/N	OPTION	HSG COLOR	CPA	MATES W/ USCAR DUAL KEY	MATES W/ USCAR SINGLE KEY	STATUS	COMMENTS
OPTIONAL LATCH	160073319	B	BLACK	YES	150-S-003-1-B01	N/A	SALEABLE	N/A
	160073318	D	BLACK	NONE	N/A	150-S-003-1-D02	SALEABLE	N/A
	160073317	B	BLACK	NONE	150-S-003-1-B01	N/A	SALEABLE	N/A
	160073316	D	ST GREY	NONE	N/A	150-S-003-1-D02	SALEABLE	N/A
	160073315	C	DK GREY	YES	N/A	150-S-003-1-C02	SALEABLE	N/A
	160073314	B	LT GREY	YES	N/A	150-S-003-1-B02	SALEABLE	N/A
	160073313	B	BLACK	NONE	N/A	150-S-003-1-B02	SALEABLE	N/A
	160073312	D	ST GREY	NONE	N/A	150-S-003-1-D02	SALEABLE	N/A
	160073311	C	DK GREY	NONE	N/A	150-S-003-1-C02	SALEABLE	N/A
	160073310	B	LT GREY	NONE	N/A	150-S-003-1-B02	SALEABLE	N/A
	160073309	A	BLACK	NONE	N/A	150-S-003-1-A02	SALEABLE	N/A
	160073308	D	ST GREY	YES	150-S-003-1-D01	N/A	SALEABLE	N/A
	160073307	C	DK GREY	YES	150-S-003-1-C01	N/A	SALEABLE	N/A
	160073306	B	LT GREY	YES	150-S-003-1-B01	N/A	SALEABLE	N/A
	160073305	A	BLACK	YES	150-S-003-1-A01	N/A	SALEABLE	N/A
	160073304	D	ST GREY	NONE	150-S-003-1-D01	N/A	SALEABLE	N/A
	160073303	C	DK GREY	NONE	150-S-003-1-C01	N/A	SALEABLE	N/A
	160073302	B	LT GREY	NONE	150-S-003-1-B01	N/A	SALEABLE	N/A
	160073301	A	BLACK	NONE	150-S-003-1-A01	N/A	SALEABLE	N/A
	342503068	D	BLACK	NONE	N/A	150-S-003-1-D02	OBsolete	SEE 160073312 OR 160073318
	342503052	D	GREY	NONE	N/A	150-S-003-1-D02	OBsolete	SEE 160073312
	342503051	C	BROWN	NONE	N/A	150-S-003-1-C02	OBsolete	SEE 160073311
	342503048	B	GREY	NONE	150-S-003-1-B01	N/A	OBsolete	SEE 160073302
	342503047	A	BLACK	NONE	150-S-003-1-A01	N/A	OBsolete	SEE 160073301
	342503066	B	BLACK	NONE	150-S-003-1-B01	N/A	OBsolete	SEE 160073302
	342503071	C	GREY	NONE	150-S-003-1-C01	N/A	OBsolete	SEE 160073307
	342503037	D	BLACK	NONE	N/A	150-S-003-1-D02	OBsolete	SEE 160073316
	342503036	D	GREY	YES	150-S-003-1-D02	N/A	OBsolete	SEE 160073316
	342503035	A	BROWN	YES	150-S-003-1-A02	N/A	OBsolete	SEE 160073315
	342503002	B	GREY	YES	150-S-003-1-B01	N/A	OBsolete	SEE 160073306
342503001	A	BLACK	YES	150-S-003-1-A01	N/A	OBsolete	SEE 160073305	
342500052	D	GREY	NONE	150-S-003-1-D01	N/A	OBsolete	SEE 160073319 OR 160073319	
342500051	C	BROWN	NONE	N/A	150-S-003-1-D02	OBsolete	SEE 160073312	
342500049	A	BLACK	NONE	N/A	150-S-003-1-B02	OBsolete	SEE 160073310	
342500036	D	GREY	NONE	N/A	150-S-003-1-D02	OBsolete	SEE 160073309	
342500035	C	GREY	NONE	N/A	150-S-003-1-C02	OBsolete	SEE 160073316	
342500034	B	GREY	NONE	N/A	150-S-003-1-B02	OBsolete	SEE 160073315	
342500033	A	BLACK	NONE	N/A	150-S-003-1-B02	OBsolete	SEE 160073314	
342500030	D	GREEN	NONE	150-S-003-1-D01	N/A	OBsolete	SEE 160073313	
342500029	B	BROWN	NONE	150-S-003-1-B01	N/A	OBsolete	SEE 160073304	
342500017	A	BLACK	NONE	150-S-003-1-A01	N/A	OBsolete	SEE 160073303	
342500016	B	GREY	NONE	150-S-003-1-B01	N/A	OBsolete	SEE 160073302	
342500014	A	BLACK	NONE	150-S-003-1-A01	N/A	OBsolete	SEE 160073301	
342500004	D	GREEN	NONE	150-S-003-1-D01	N/A	OBsolete	SEE 160073308	
342500003	C	BROWN	YES	150-S-003-1-C01	N/A	OBsolete	SEE 160073307	
342500002	B	GREY	YES	150-S-003-1-B01	N/A	OBsolete	SEE 160073306	
342500001	A	BLACK	YES	150-S-003-1-A01	N/A	OBsolete	SEE 160073305	

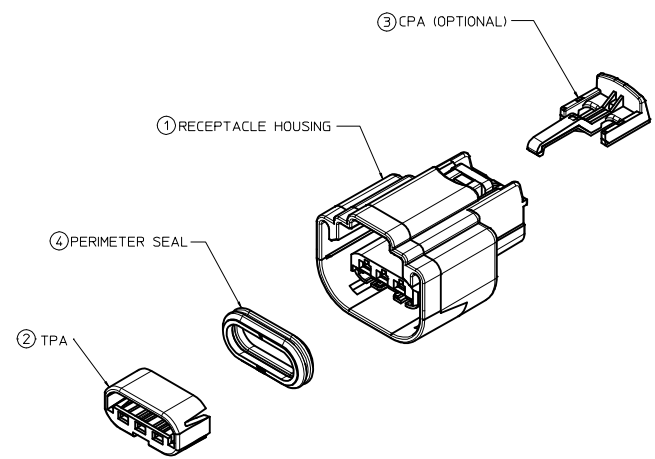
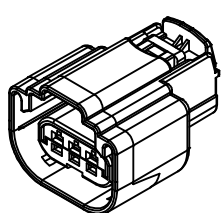

ADD PART NUMBER EC NO. UAU2015-0698 DRWNG. NO. 20160720 CHKD. CJK APPRVD. KOSKI REV. 2017/02/08	QUALITY SYMBOLS ✓ -0 ✓ -1 ✓ -2 ✓ -3	GENERAL TOLERANCES (UNLESS SPECIFIED) DIMENSIONS IN MILLIMETERS DIMENSIONS IN INCHES 4 PLACES ± 0.15 3 PLACES ± 0.10 2 PLACES ± 0.10 1 PLACE ± 0.3 ANGULAR ± 3°	DIMENSION STYLE MM ONLY DRAWN BY: L.P.LIM DATE: 2003/09/03 CHECKED BY: DATE: APPROVED BY: KDEKOSKI DATE: 2017/02/08	SCALE: 2:1 DESIGN UNITS: METRIC THIRD ANGLE PROJECTION	TITLE: RECEPTACLE ASSEMBLY 3-WAY USCAR CONNECTOR 15MM CABLE SEAL MATERIAL NO. SD-160073-001 DOCUMENT NO. 1 OF 3
	SEE CHART THIS DRAWING CONTAINS INFORMATION THAT IS PROPRIETARY TO MOLEX INCORPORATED AND SHOULD NOT BE USED WITHOUT WRITTEN PERMISSION				
	SHEET NO. 1 OF 3				
	MOLEX INCORPORATED				

SHEET DESCRIPTION

KEY CONFIGURATION

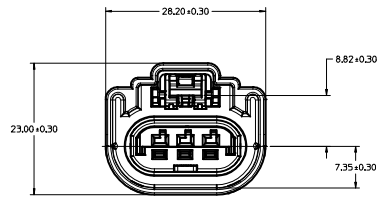

DUAL KEY OPTION 'A'

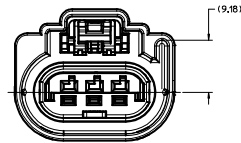

SINGLE KEY OPTION 'A'

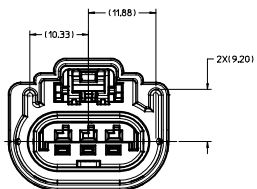

DUAL KEY OPTION 'B'

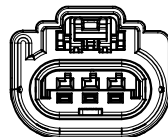

SINGLE KEY OPTION 'B'

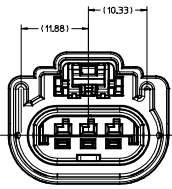

DUAL KEY OPTION 'C'

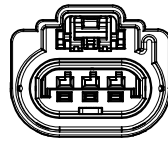

SINGLE KEY OPTION 'C'

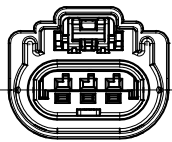

DUAL KEY OPTION 'D'

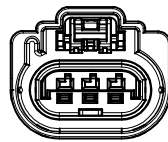

SINGLE KEY OPTION 'D'

ENTER DESCRIPTION EC NO: UAU2015-1698 DRAWN BY: D DATE: 2016/07/20 APPROVED BY: KDK/KOSKI DATE: 2017/02/08 DESCRIPTION:	QUALITY SYMBOLS ▽=0 ▽=0 ▽=0	GENERAL TOLERANCES (UNLESS SPECIFIED) mm INCH 4 PLACES ± --- ± --- 3 PLACES ± --- ± --- 2 PLACES ± 0.10 ± --- 1 PLACE ± 0.3 ± --- 0 PLACE ± ±	DIMENSION STYLE MM ONLY DRAWN BY: L.P.LIM DATE: 2003/09/03 CHECKED BY: DATE: APPROVED BY: KDK/KOSKI DATE: 2017/02/08	SCALE: 3:1 DESIGN UNITS: METRIC THIRD ANGLE PROJECTION	TITLE: RECEPTACLE ASSEMBLY 3-WAY USCAR CONNECTOR 15MM CABLE SEAL molex	MATERIAL NO.: DOCUMENT NO.: SD-160073-001 SHEET NO.: 2 OF 3
	DRAFT WHERE APPLICABLE MUST REMAIN WITHIN DIMENSIONS		SEE CHART		THIS DRAWING CONTAINS INFORMATION THAT IS PROPRIETARY TO MOLEX INCORPORATED AND SHOULD NOT BE USED WITHOUT WRITTEN PERMISSION	
	ANGULAR ± 3°		SIZE: E		INCORPORATED AND SHOULD NOT BE USED WITHOUT WRITTEN PERMISSION	

SHEET DESCRIPTION
RECEPTACLE CONNECOTR ASSEMBLY

ASSEMBLY MATERIALS				
ITEM	DESCRIPTION	COLOR	MOLEX P/N	RECYCLE CODE
1	RECEPTACLE HOUSING	SEE CHART	SEE CHART	PA6 GF40 (FOR 160073 SERIES)
2	TPA	NATURAL	342520001	PBT-GF30
3	CPA	RED	340660001	PBT-GF30
4	PERIMETER SEAL	BLUE	342530001	SILICON 50 DUROMETER
		BLUE	342530002	SILICON 50 DUROMETER

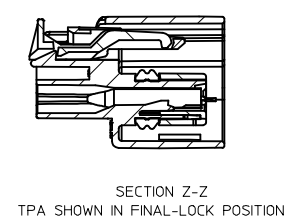
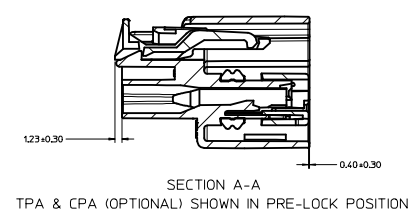
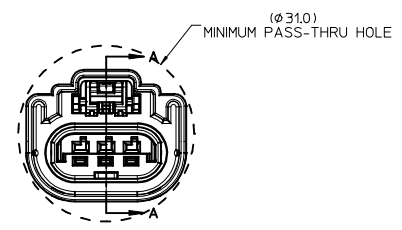
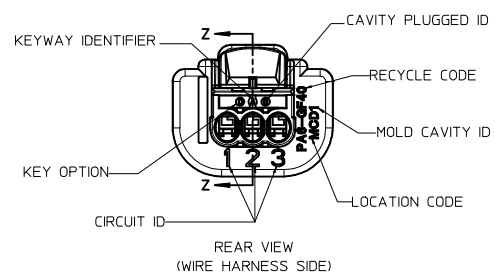
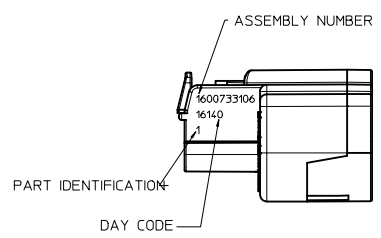

ENTER DESCRIPTION EC NO: UAU2015-6598 DRAWN BY: DRINKTMA DATE: 2016/07/20 APPROVED BY: KAPRUBOESKI DATE: 2017/02/08 REV:	QUALITY SYMBOLS ∇=0 ∇=0 ∇=0	GENERAL TOLERANCES (UNLESS SPECIFIED) mm INCH 4 PLACES ± --- ± --- 3 PLACES ± --- ± --- 2 PLACES ± 0.10 ± --- 1 PLACE ± 0.3 ± --- 0 PLACE ± ±	DIMENSION STYLE MM ONLY DRAWN BY: L.P.LIM DATE: 2003/09/03 CHECKED BY: DATE: APPROVED BY: KDEKOSKI DATE: 2017/02/08	SCALE: 3:1 DESIGN UNITS: METRIC THIRD ANGLE PROJECTION	TITLE: RECEPTACLE ASSEMBLY 3-WAY USCAR CONNECTOR 15MM CABLE SEAL molex	MATERIAL NO.: DOCUMENT NO.: SD-160073-001 SHEET NO.: 3 OF 3
	DRAFT WHERE APPLICABLE MUST REMAIN WITHIN DIMENSIONS		SEE CHART		THIS DRAWING CONTAINS INFORMATION THAT IS PROPRIETARY TO MOLEX INCORPORATED AND SHOULD NOT BE USED WITHOUT WRITTEN PERMISSION	
	ANGULAR ± 3°		SIZE:		INCORPORATED AND SHOULD NOT BE USED WITHOUT WRITTEN PERMISSION	
	DRAFT WHERE APPLICABLE MUST REMAIN WITHIN DIMENSIONS		SEE CHART		THIS DRAWING CONTAINS INFORMATION THAT IS PROPRIETARY TO MOLEX INCORPORATED AND SHOULD NOT BE USED WITHOUT WRITTEN PERMISSION	

AWG	PART NUMBER	PA/OFF DIRECTION	PLATING	GRP	QSR P/N	WIRE OD RANGE	CABLE SEAL (QSR)	COLOR
22	34083-2003	RIGHT	TIN	22	E-1644-01	1.19-1.65		PINK
22	34083-3003	LEFT	TIN	22				
22	34081-2005	RIGHT	GOLD	22				
20	34083-2002	RIGHT	TIN	18/20				
20	34083-3002	LEFT	TIN	18/20	E-1644-00	1.60-2.10	GREEN	
20	34081-2004	RIGHT	GOLD	18/20				
20	34081-3004	LEFT	TIN	18/20				
18	34083-2002	RIGHT	GOLD	18/20				
18	34083-3002	LEFT	TIN	18/20	E-1644-02	2.10-2.50	YELLOW	
18	34081-2004	RIGHT	GOLD	18/20				
16	34083-2001	RIGHT	TIN	16				
16	34083-3001	LEFT	TIN	16				
16	34081-2003	RIGHT	GOLD	16				
16	34081-3003	LEFT	GOLD	16				

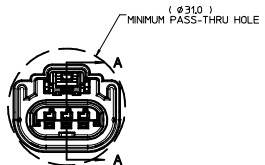
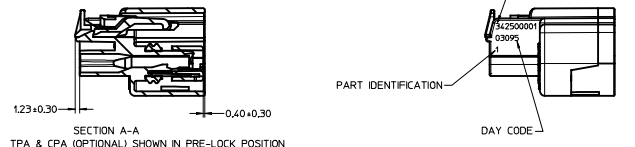
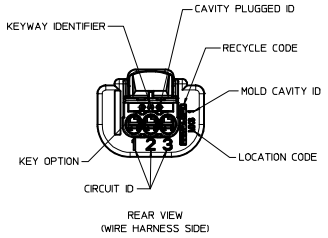
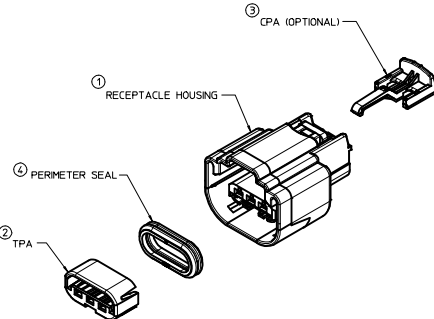
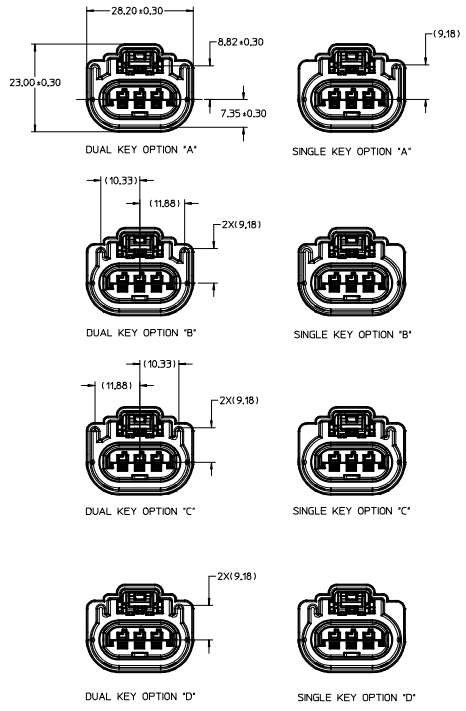

OPTIONAL LATCH	STANDARD	STANDARD	STANDARD	STANDARD	LATCH STYLE	KEY OPTION	HSG COLOR	CPA	MATES W/ USCAR DUAL KEY	MATES W/ USCAR SINGLE KEY	STATUS
160073319	342503068	342503069	342503070	342503071	ASSEMBLY	B	BLACK	YES	150-S-003-1-B01	N/A	SALEABLE
160073318	342503068	342503068	342503068	342503068	KEY	D	BLACK	NONE	N/A	150-S-003-1-D02	SALEABLE
160073317	342503069	342503069	342503069	342503069	OPTION	B	BLACK	YES	150-S-003-1-B01	N/A	SALEABLE
160073316	342503070	342503070	342503070	342503070		D	ST GREY	YES	N/A	150-S-003-1-D02	SALEABLE
160073315	342503071	342503071	342503071	342503071		C	DK GREY	YES	N/A	150-S-003-1-C02	SALEABLE
160073314	342503072	342503072	342503072	342503072		B	LT GREY	YES	N/A	150-S-003-1-B02	SALEABLE
160073313	342503073	342503073	342503073	342503073		A	BLACK	YES	N/A	150-S-003-1-A02	SALEABLE
160073312	342503074	342503074	342503074	342503074		D	ST GREY	YES	N/A	150-S-003-1-D02	SALEABLE
160073311	342503075	342503075	342503075	342503075		C	DK GREY	NONE	N/A	150-S-003-1-C02	SALEABLE
160073310	342503076	342503076	342503076	342503076		B	LT GREY	YES	150-S-003-1-B01	150-S-003-1-A02	SALEABLE
160073309	342503077	342503077	342503077	342503077		A	BLACK	YES	150-S-003-1-C01	N/A	SALEABLE
160073308	342503078	342503078	342503078	342503078		D	ST GREY	YES	150-S-003-1-D01	N/A	SALEABLE
160073307	342503079	342503079	342503079	342503079		C	DK GREY	YES	150-S-003-1-C01	N/A	SALEABLE
160073306	342503080	342503080	342503080	342503080		B	LT GREY	YES	150-S-003-1-B01	N/A	SALEABLE
160073305	342503081	342503081	342503081	342503081		A	BLACK	YES	150-S-003-1-A01	N/A	SALEABLE
160073304	342503082	342503082	342503082	342503082		D	ST GREY	YES	150-S-003-1-D01	N/A	SALEABLE
160073303	342503083	342503083	342503083	342503083		C	DK GREY	NONE	150-S-003-1-C01	N/A	SALEABLE
160073302	342503084	342503084	342503084	342503084		B	LT GREY	YES	150-S-003-1-B01	N/A	SALEABLE
160073301	342503085	342503085	342503085	342503085		A	BLACK	YES	150-S-003-1-A01	N/A	SALEABLE
342503068	342503068	342503068	342503068	342503068		D	BLACK	NONE	N/A	150-S-003-1-D02	SALEABLE
342503069	342503069	342503069	342503069	342503069		D	GREY	YES	N/A	150-S-003-1-D02	SALEABLE
342503070	342503070	342503070	342503070	342503070		C	BROWN	NONE	N/A	150-S-003-1-C02	SALEABLE
342503071	342503071	342503071	342503071	342503071		B	GREY	YES	150-S-003-1-B01	N/A	SALEABLE
342503072	342503072	342503072	342503072	342503072		A	BLACK	YES	150-S-003-1-A01	N/A	DESIGN CONCEPT ONLY
342503073	342503073	342503073	342503073	342503073		D	BLACK	YES	150-S-003-1-D01	N/A	SALEABLE
342503074	342503074	342503074	342503074	342503074		C	GREY	YES	150-S-003-1-C01	N/A	SALEABLE
342503075	342503075	342503075	342503075	342503075		D	BLACK	YES	150-S-003-1-D02	N/A	SALEABLE
342503076	342503076	342503076	342503076	342503076		B	BLACK	YES	150-S-003-1-B01	N/A	SALEABLE
342503077	342503077	342503077	342503077	342503077		A	GREY	YES	150-S-003-1-A01	N/A	SALEABLE
342503078	342503078	342503078	342503078	342503078		C	BROWN	YES	150-S-003-1-C02	N/A	SALEABLE
342503079	342503079	342503079	342503079	342503079		D	GREY	YES	150-S-003-1-D01	N/A	SALEABLE
342503080	342503080	342503080	342503080	342503080		B	BLACK	YES	150-S-003-1-B01	N/A	SALEABLE
342503081	342503081	342503081	342503081	342503081		A	BLACK	YES	150-S-003-1-A01	N/A	DESIGN CONCEPT ONLY

- UNLESS OTHERWISE SPECIFIED:
- PART CONFORMS TO SAE/USCAR-2 REV. 4 (05/04), EXCEPT AS FOLLOWS:
 - DESIGNED TO MATE WITH DEVICE CONNECTION AS SPECIFIED IN USCAR/EWCAP DRAWING NO 150-S-003-1-202, ALL OPTION A-D, REV. 4, DATED 10/19/99, ALSO WITH THE DEVICE CONNECTION AS SPECIFIED IN USCAR/EWCAP DRAWING NO 150-S-003-1-201, ALL OPTION A-D, REV. D, DATED 10/15/02.
 - ASSEMBLY SHIPPED WITH TPA IN PRE-LOCK POSITION (SEE SECTION A-A PRELCK) UPON FULL TERMINAL ASSEMBLY, TPA MUST BE SNAPPED INTO ITS FINAL LOCK POSITION AFTER TERMINALS ARE ASSEMBLED.
 - OPTIONAL CPA SHOWN IN ALL VIEWS. SEE TABLE FOR SPECIFIC ASSEMBLY OPTION AND NUMBER.
 - FOR PREFERRED TERMINALS SEE MOLEX DRAWING SD-34083-002 FOR OPTIONAL TERMINALS SEE MOLEX DRAWING SD-34083-001

ITEM	DESCRIPTION	COLOR	MOLEX P/N	RECYCLE CODE
1	RECEPTACLE HOUSING	SEE CHART	SEE CHART	PPE/PA GF10 (FOR 34250 SERIES) PA6 GF40 (FOR 160073 SERIES)
2	TPA	NATURAL	342520001	PBT-GF30
3	CPA	RED	340660001	PBT-GF30
4	PERMETER SEAL	BLUE	342530001	SILICON 50 DIAPHRAGM
		BLUE	342530002	SILICON 50 DIAPHRAGM

ADD PART NUMBER REC NO: 04/2016-1714 DRAWING NO: 2016/05/24 APPROVED: 2016/05/24 REV: P1	QUALITY SYMBOLS 0 4 PLACES ± --- ± --- 3 PLACES ± --- ± --- 2 PLACES ± 0.10 ± --- 1 PLACE ± 0.3 ± --- ANGULAR ± 3°	GENERAL TOLERANCES (UNLESS SPECIFIED) mm INCH ± --- ± --- ± --- ± --- ± --- ± ---	DIMENSION STYLE MM ONLY DRAWN BY: L.P.LIM DATE: 2003/09/03 CHECKED BY: DATE:	SCALE: 2:1 DESIGN UNITS: METRIC THIRD ANGLE PROJECTION
	DRAFT WHERE APPLICABLE MUST REMAIN WITHIN DIMENSIONS		APPROVED BY: WKOSHY DATE: 2010/11/11 MATERIAL NO.: SEE CHART DOCUMENT NO.: SD-34250-002 SHEET NO.: 1 OF 1	

RECEPTACLE ASSEMBLY
3-WAY USCAR CONNECTOR
15MM CABLE SEAL

MOLEX INCORPORATED

THIS DRAWING CONTAINS INFORMATION THAT IS PROPRIETARY TO MOLEX INCORPORATED AND SHOULD NOT BE USED WITHOUT WRITTEN PERMISSION