

1612963-4 ✓ ACTIVE

TE Internal #: 1612963-4

DC Jack Connectors, Board-to-Board, 10 Position, 2 mm [.079 in]

Centerline, Receptacle, 30 VDC, Vertical, Printed Circuit Board,

Power & Signal

[View on TE.com >](#)



Connectors > PCB Connectors > Battery Connectors & Holders > DC Jack Connectors

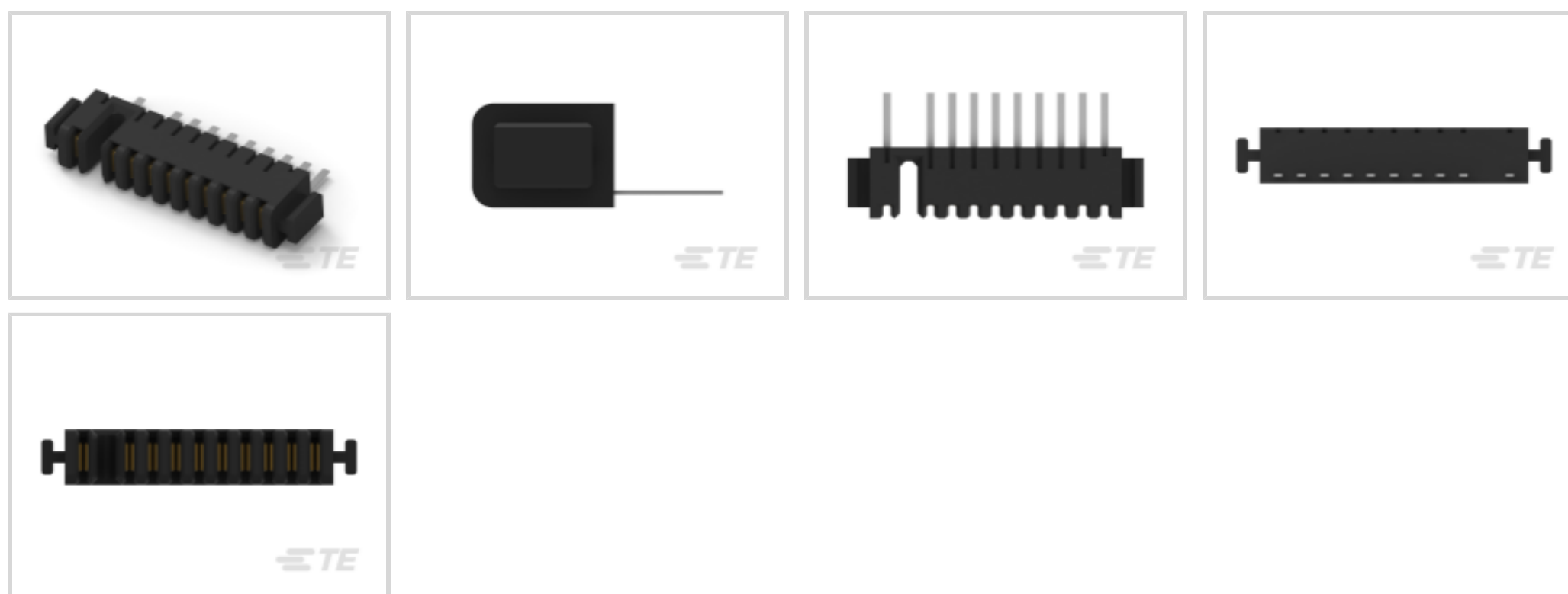

Connector System: **Board-to-Board**

Number of Positions: **10**

Centerline (Pitch): **2 mm [.079 in]**

Connector & Housing Type: **Receptacle**

Operating Voltage: **30 VDC**

## Features

### Product Type Features

Connector System	Board-to-Board
Connector & Housing Type	Receptacle
Sealable	No
Connector & Contact Terminates To	Printed Circuit Board

### Configuration Features

Number of Positions	10
PCB Mount Orientation	Vertical

### Electrical Characteristics

Operating Voltage	30 VDC
-------------------	--------

### Contact Features

Contact Current Rating (Max)	6 A, 8 A
------------------------------	----------

### Mechanical Attachment

PCB Mount Retention	Without
Connector Mounting Type	Board Mount



### Housing Features

Centerline (Pitch)	2 mm [.079 in]
--------------------	----------------

### Usage Conditions

Operating Temperature Range	-20 – 80 °C [-4 – 176 °F]
-----------------------------	---------------------------

### Operation/Application

Circuit Application	Power & Signal
---------------------	----------------

### Packaging Features

Packaging Method	Box & Tray
------------------	------------

## Product Compliance

For compliance documentation, visit the product page on [TE.com](https://www.te.com)>

EU RoHS Directive 2011/65/EU	Compliant
EU ELV Directive 2000/53/EC	Compliant
China RoHS 2 Directive MIIT Order No 32, 2016	No Restricted Materials Above Threshold
EU REACH Regulation (EC) No. 1907/2006	Current ECHA Candidate List: JUNE 2022 (224) Candidate List Declared Against: JAN 2022 (223) SVHC > Threshold: Not Yet Reviewed
Halogen Content	Not Low Halogen - contains Br or Cl > 900 ppm.
Solder Process Capability	Wave solder capable to 265°C

#### Product Compliance Disclaimer

This information is provided based on reasonable inquiry of our suppliers and represents our current actual knowledge based on the information they provided. This information is subject to change. The part numbers that TE has identified as EU RoHS compliant have a maximum concentration of 0.1% by weight in homogenous materials for lead, hexavalent chromium, mercury, PBB, PBDE, DBP, BBP, DEHP, DIBP, and 0.01% for cadmium, or qualify for an exemption to these limits as defined in the Annexes of Directive 2011/65/EU (RoHS2). Finished electrical and electronic equipment products will be CE marked as required by Directive 2011/65/EU. Components may not be CE marked. Additionally, the part numbers that TE has identified as EU ELV compliant have a maximum concentration of 0.1% by weight in homogenous materials for lead, hexavalent chromium, and mercury, and 0.01% for cadmium, or qualify for an exemption to these limits as defined in the Annexes of Directive 2000/53/EC (ELV). Regarding the REACH Regulation, the information TE provides on SVHC in articles for this part number is based on the latest European Chemicals Agency (ECHA) 'Guidance on requirements for substances in articles' posted at this URL: <https://echa.europa.eu/guidance-documents/guidance-on-reach>

## Compatible Parts

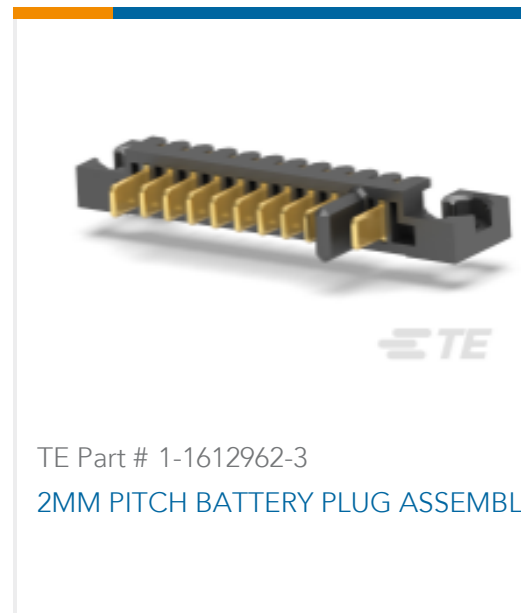
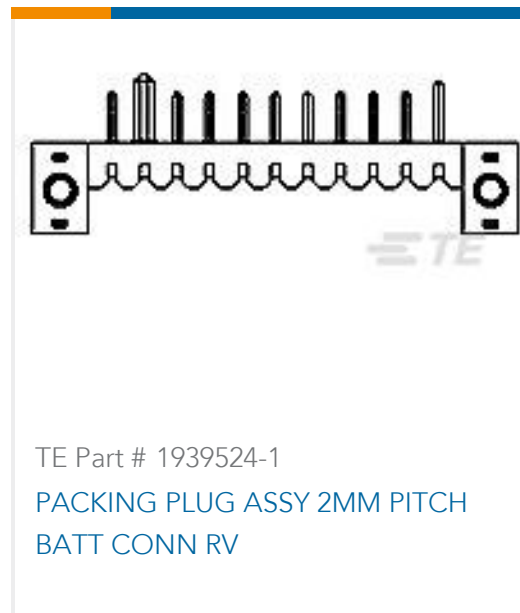

### Customers Also Bought

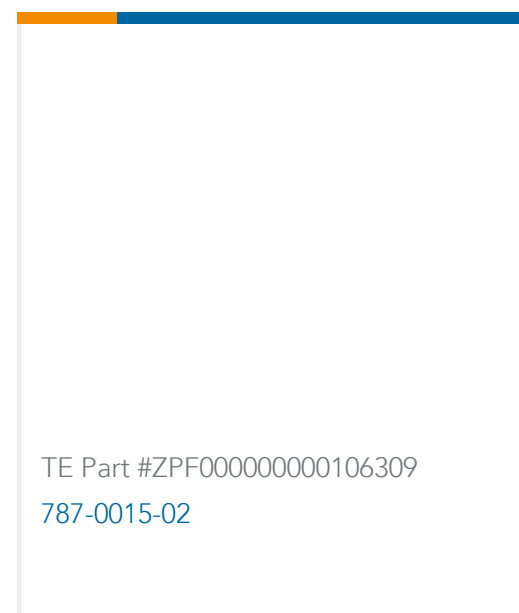
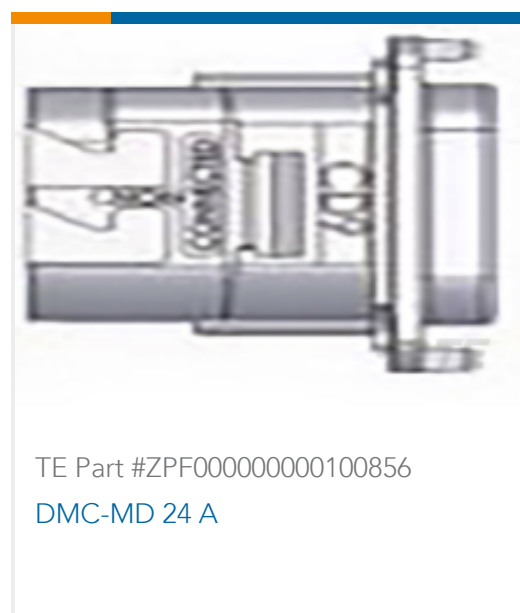
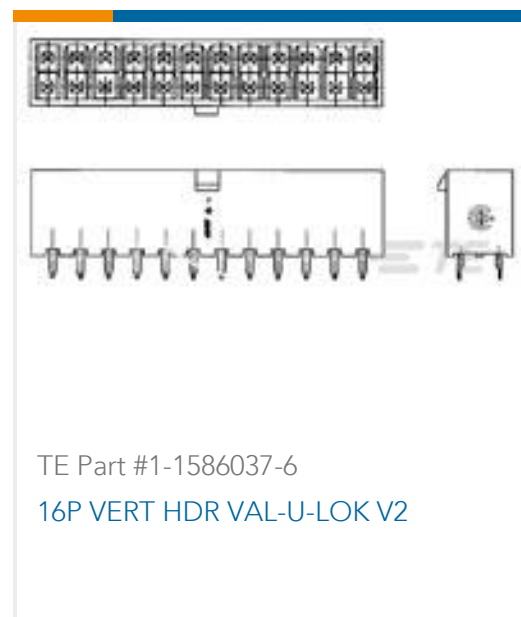

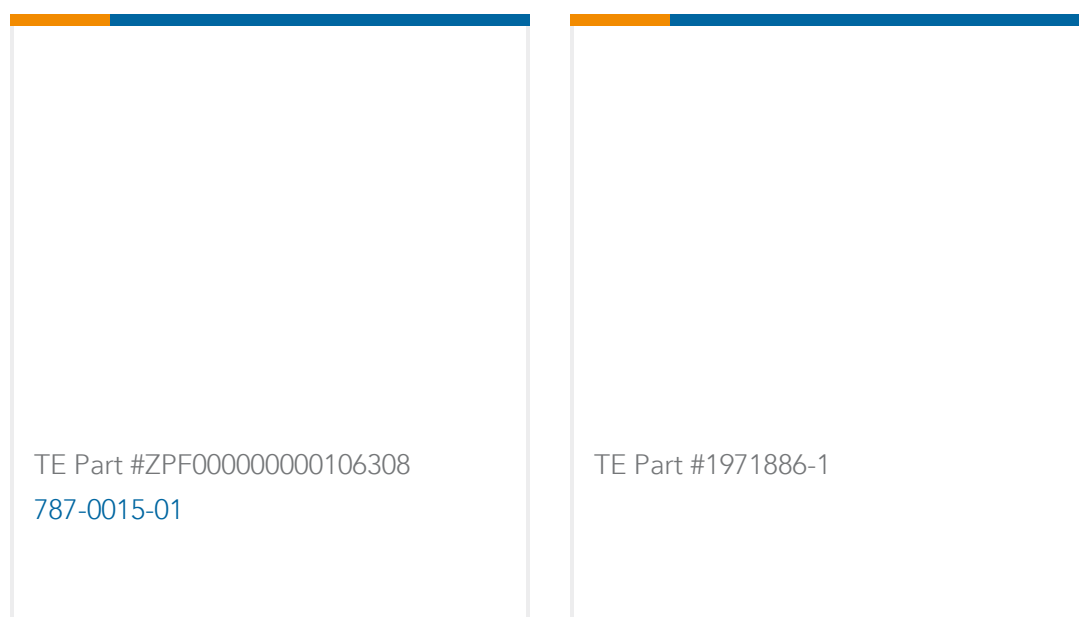

## Documents

### Product Drawings

[2MM PITCH BATTERY REC. ASSY 10P, L=5](#)

English

### CAD Files

Customer View Model

[ENG\\_CVM\\_CVM\\_1612963-4\\_C.2d\\_dxf.zip](#)

English

[3D PDF](#)

3D

Customer View Model

[ENG\\_CVM\\_CVM\\_1612963-4\\_C.3d\\_igs.zip](#)

English

Customer View Model

[ENG\\_CVM\\_CVM\\_1612963-4\\_C.3d\\_stp.zip](#)

English

By downloading the CAD file I accept and agree to the [Terms and Conditions](#) of use.

### Datasheets & Catalog Pages

[POWER\\_CONNECTORS\\_CATALOG\\_SEC09\\_LAPTOPS\\_PORTABLES](#)

English

[2\\_PIECE\\_POWER\\_CONNECTORS\\_qrg\\_4-1773458-1](#)

English

### Product Specifications

[Product Specification](#)

English

[Product Specification](#)

Japanese