



VAL-U-LOK

TE Internal #: 1586765-8

Rectangular Power Connectors, Housing, Receptacle, Wire-to-Board / Wire-to-Wire, 8 Position, .165 in [4.2 mm] Centerline, Wire & Cable, UL 94V-2

[View on TE.com >](#)

Connectors > Power Connectors > Rectangular Power > Rectangular Power Connectors

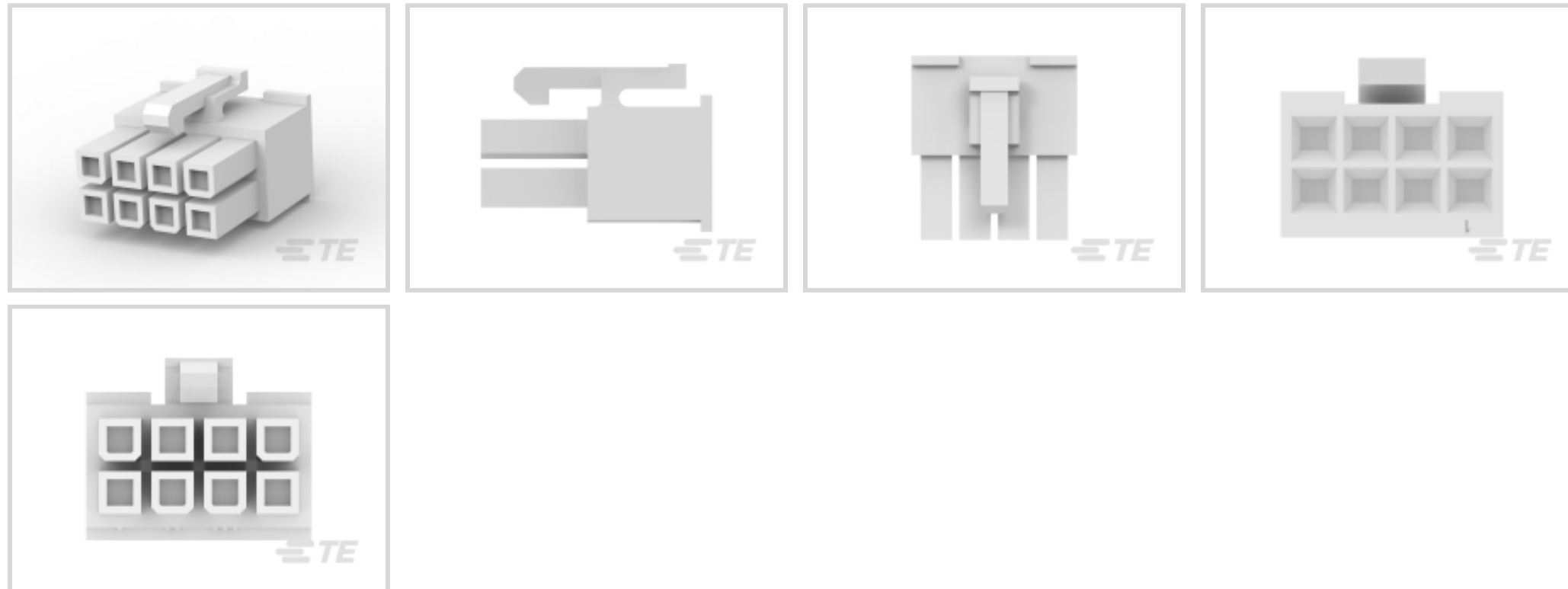

Rectangular Power Connector Type: **Housing**

Connector & Housing Type: **Receptacle**

Connector System: **Wire-to-Board, Wire-to-Wire**

Number of Positions: **8**

Centerline (Pitch): **4.2 mm [ .165 in ]**

**Features**

**Product Type Features**

Rectangular Power Connector Type	Housing
Connector & Housing Type	Receptacle
Connector System	Wire-to-Board, Wire-to-Wire
Sealable	No
Connector & Contact Terminates To	Wire & Cable

**Configuration Features**

Number of Positions	8
Number of Rows	2

**Electrical Characteristics**

Operating Voltage	600 VAC
-------------------	---------

**Contact Features**

Contact Layout	Matrix
Contact Retention Within Housing	Without
Contact Type	Receptacle



### Termination Features

Termination Method to Wire & Cable	Crimp
Wire/Cable Type	Discrete Wire

### Mechanical Attachment

Connector Mounting Type	Cable Mount (Free-Hanging)
-------------------------	----------------------------

### Housing Features

Centerline (Pitch)	4.2 mm [.165 in]
Housing Color	White
Housing Material	Polyamide

### Dimensions

Row-to-Row Spacing	4.2 mm [.165 in]
Width	20 mm [.787 in]
Accepts Wire Insulation Diameter Range	1.2 – 3.1 mm [.047 – .122 in]
Height	11.8 mm [.464 in]
Length	18 mm [.709 in]

### Usage Conditions

Operating Temperature Range	-40 – 105 °C [-40 – 221 °F]
-----------------------------	-----------------------------

### Operation/Application

Circuit Application	Power & Signal
---------------------	----------------

### Identification Marking

Circuit Identification Feature	With
--------------------------------	------

### Industry Standards

UL Flammability Rating	UL 94V-2
Glow Wire Rating	GWT 750°C (Without Flame)
Agency/Standard Number	E28476
Agency/Standard	CSA, UL
UL Rating	Recognized
CSA File Number	208567

### Packaging Features

Packaging Method	Bag
Packaging Quantity	500

## Product Compliance



[For compliance documentation, visit the product page on TE.com>](#)

EU RoHS Directive 2011/65/EU	Compliant
EU ELV Directive 2000/53/EC	Not Yet Reviewed
China RoHS 2 Directive MIIT Order No 32, 2016	No Restricted Materials Above Threshold
EU REACH Regulation (EC) No. 1907/2006	Current ECHA Candidate List: JUNE 2022 (224) Candidate List Declared Against: JUL 2021 (219) SVHC > Threshold: Not Yet Reviewed
Halogen Content	Not Low Halogen - contains Br or Cl > 900 ppm.
Solder Process Capability	Not applicable for solder process capability

### Product Compliance Disclaimer

This information is provided based on reasonable inquiry of our suppliers and represents our current actual knowledge based on the information they provided. This information is subject to change. The part numbers that TE has identified as EU RoHS compliant have a maximum concentration of 0.1% by weight in homogenous materials for lead, hexavalent chromium, mercury, PBB, PBDE, DBP, BBP, DEHP, DIBP, and 0.01% for cadmium, or qualify for an exemption to these limits as defined in the Annexes of Directive 2011/65/EU (RoHS2). Finished electrical and electronic equipment products will be CE marked as required by Directive 2011/65/EU. Components may not be CE marked. Additionally, the part numbers that TE has identified as EU ELV compliant have a maximum concentration of 0.1% by weight in homogenous materials for lead, hexavalent chromium, and mercury, and 0.01% for cadmium, or qualify for an exemption to these limits as defined in the Annexes of Directive 2000/53/EC (ELV). Regarding the REACH Regulation, the information TE provides on SVHC in articles for this part number is based on the latest European Chemicals Agency (ECHA) 'Guidance on requirements for substances in articles' posted at this URL: <https://echa.europa.eu/guidance-documents/guidance-on-reach>

## Compatible Parts

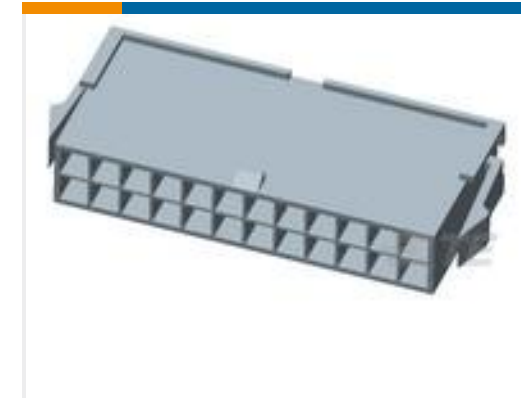
 <p>TE Part # 1586862-8 8P FH PLUG VAL-U-LOK FH GW</p>	 <p>TE Part # 1586861-8 8P PM PLUG VAL-U-LOK PM GW</p>	 <p>TE Part # 2296206-8 8P FH PLUG VAL-U-LOK FH GWT/V0</p>	 <p>TE Part # 2296207-8 8P PM PLUG VAL-U-LOK PM GWT/V0</p>
---	--	---	---



### Customers Also Bought

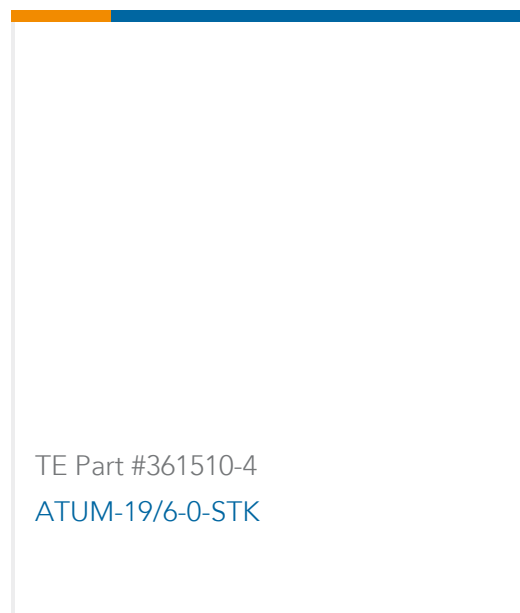
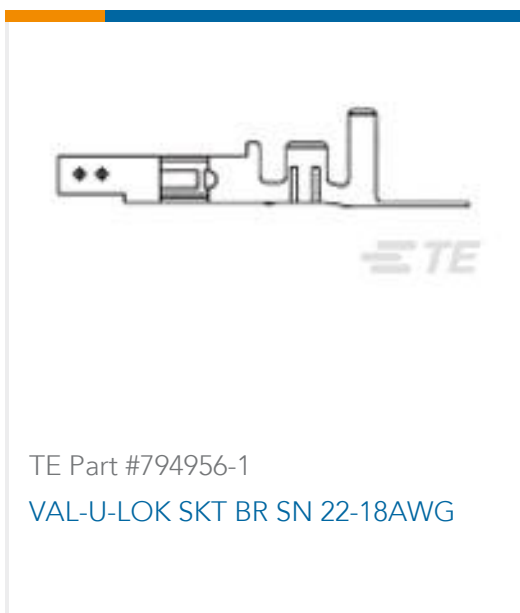
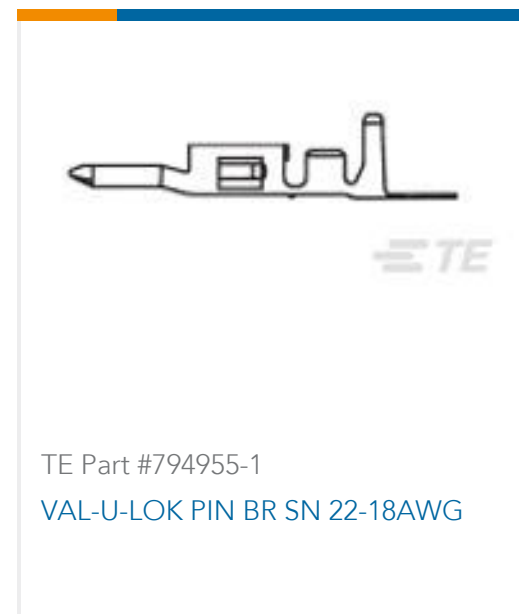
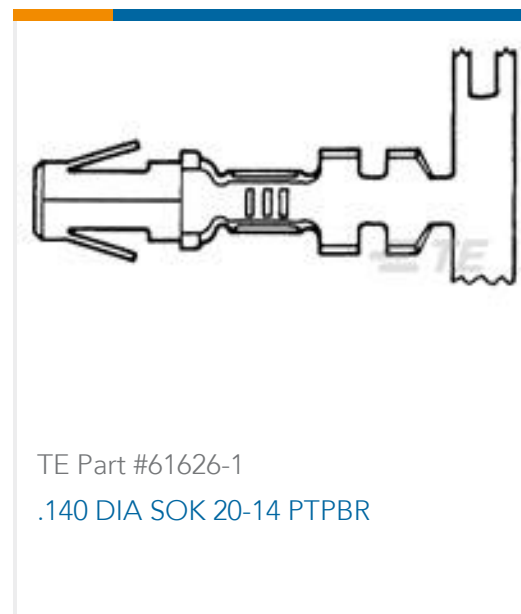
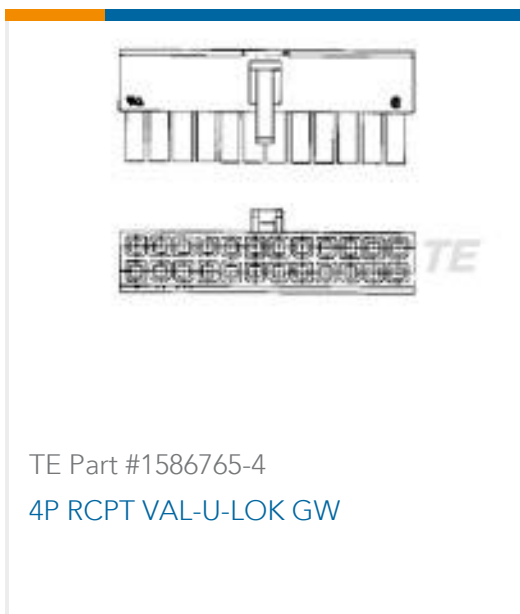

### Documents

#### Product Drawings

8P RCPT VAL-U-LOK GW

English

#### CAD Files

3D PDF

3D

Customer View Model

ENG\_CVM\_CVM\_1586765-8\_D.2d\_dxf.zip



English

**Customer View Model**

[ENG\\_CVM\\_CVM\\_1586765-8\\_D.3d\\_igs.zip](#)

English

**Customer View Model**

[ENG\\_CVM\\_CVM\\_1586765-8\\_D.3d\\_stp.zip](#)

English

By downloading the CAD file I accept and agree to the [Terms and Conditions](#) of use.

---

**Datasheets & Catalog Pages**

[VAL-U-LOK\\_GLOW\\_WIRE\\_CONNECTORS](#)

English

---

**Product Specifications**

[Application Specification](#)

English

---

**Product Environmental Compliance**

[MD\\_1586765-8\\_06122018953\\_dmtec](#)

English

[MD\\_1586765-8\\_06122018953\\_dmtec](#)

English

---

**Agency Approvals**

[UL Report](#)

English