

144998-6 ✓ ACTIVE

AMP | Junior Power Timer

TE Internal #: 144998-6

Housing for Female Terminals, Wire-to-Wire, 4 Position, .197 in [5 mm] Centerline, Sealable, Green, Signal, Junior Power Timer

[View on TE.com >](#)



Connectors > Automotive Connectors > Connector Housings > TIMER, CONNECTOR HOUSING



Connector & Housing Type: **Housing for Female Terminals**

Mating Tab Width: **2.8 mm [.11 in]**

Connector System: **Wire-to-Wire**

Number of Positions: **4**

Centerline (Pitch): **5 mm [.197 in]**

[All TIMER, CONNECTOR HOUSING \(543\)](#)

Features

Product Type Features

Connector & Housing Shape	Rectangular
Connector & Housing Type	Housing for Female Terminals
Connector System	Wire-to-Wire
Sealable	Yes
Hybrid Connector	No
Primary Locking Feature	On the Terminal

Configuration Features

Number of Positions	4
Number of Rows	1

Electrical Characteristics

Operating Voltage	16 VDC
Nominal Voltage Architecture	12 V

Body Features

Cable Exit Angle	180°
Body Material	PBT GF
Primary Product Color	Green
Connector Code	E1



Contact Features

Contact Size	2.8mm
Contact Type	Receptacle
Mating Tab Width	2.8 mm[.11 in]

Mechanical Attachment

Mounting Feature	Without
Terminal Position Assurance	Yes
Strain Relief	Without
Mating Alignment Type	Keyed
Mating Alignment	With
Connector Mounting Type	Cable Mount (Free-Hanging)

Housing Features

Centerline (Pitch)	5 mm[.197 in]
--------------------	---------------

Dimensions

Product Width	37.75 mm[1.486 in]
Product Length	37.4 mm[1.472 in]
Product Height	21.5 mm[.846 in]

Usage Conditions

Operating Temperature (Max)	70 °C, 75 °C, 80 °C, 85 °C, 90 °C, 100 °C [158 °F][167 °F][176 °F][185 °F][194 °F][212 °F]
Operating Temperature Range	-40 – 100 °C[-40 – 212 °F]

Operation/Application

Circuit Application	Signal
---------------------	--------

Industry Standards

UL Flammability Rating	UL 94HB
------------------------	---------

Packaging Features

Packaging Quantity	500
Packaging Method	Box

Other

Serviceable	Yes
Connector Position Assurance Capable	No



Product Compliance

[For compliance documentation, visit the product page on TE.com>](#)

EU RoHS Directive 2011/65/EU	Compliant
EU ELV Directive 2000/53/EC	Compliant
China RoHS 2 Directive MIIT Order No 32, 2016	No Restricted Materials Above Threshold
EU REACH Regulation (EC) No. 1907/2006	Current ECHA Candidate List: JUNE 2022 (224) Candidate List Declared Against: JUN 2020 (209) SVHC > Threshold: Not Yet Reviewed
Halogen Content	BFR/CFR/PVC Free, but Br/Cl >900 ppm in other sources.
Solder Process Capability	Not applicable for solder process capability

Product Compliance Disclaimer

This information is provided based on reasonable inquiry of our suppliers and represents our current actual knowledge based on the information they provided. This information is subject to change. The part numbers that TE has identified as EU RoHS compliant have a maximum concentration of 0.1% by weight in homogenous materials for lead, hexavalent chromium, mercury, PBB, PBDE, DBP, BBP, DEHP, DIBP, and 0.01% for cadmium, or qualify for an exemption to these limits as defined in the Annexes of Directive 2011/65/EU (RoHS2). Finished electrical and electronic equipment products will be CE marked as required by Directive 2011/65/EU. Components may not be CE marked. Additionally, the part numbers that TE has identified as EU ELV compliant have a maximum concentration of 0.1% by weight in homogenous materials for lead, hexavalent chromium, and mercury, and 0.01% for cadmium, or qualify for an exemption to these limits as defined in the Annexes of Directive 2000/53/EC (ELV). Regarding the REACH Regulation, the information TE provides on SVHC in articles for this part number is based on the latest European Chemicals Agency (ECHA) 'Guidance on requirements for substances in articles' posted at this URL: <https://echa.europa.eu/guidance-documents/guidance-on-reach>

Compatible Parts

 <p>TE Part # 828922-1 2,5MM CAVITY PLUG FOR 5,4MM DI</p>	 <p>TE Part # 828905-1 SINGLE-WIRE-SEAL(5MM HOLE)</p>	 <p>TE Part # CAT-T4827-T273 TIMER, RECEPTACLE AND TAB</p>	 <p>TE Part # 185001-6 4P TAB JPT HOUSING</p>
--	--	---	--



TE Part # 828904-1
SINGLE WIRE SEAL FOR J.P.T.CON

Also in the Series | Junior Power Timer

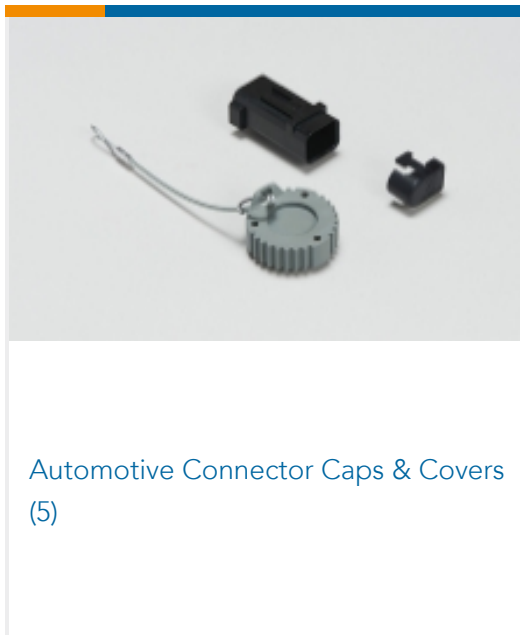

Automotive Connector Caps & Covers (5)

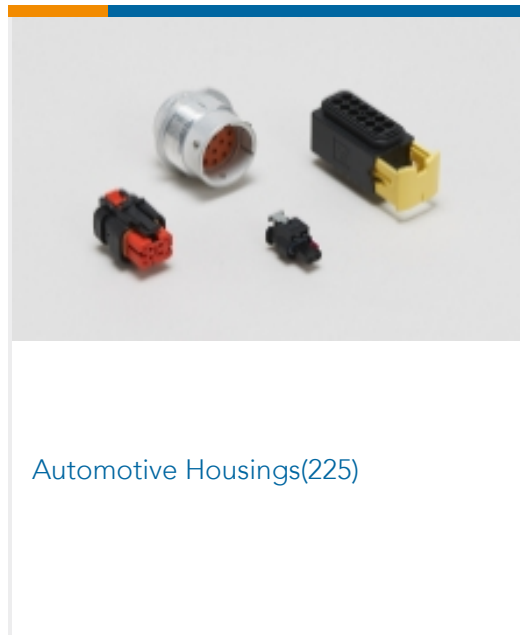

Automotive Housings(225)

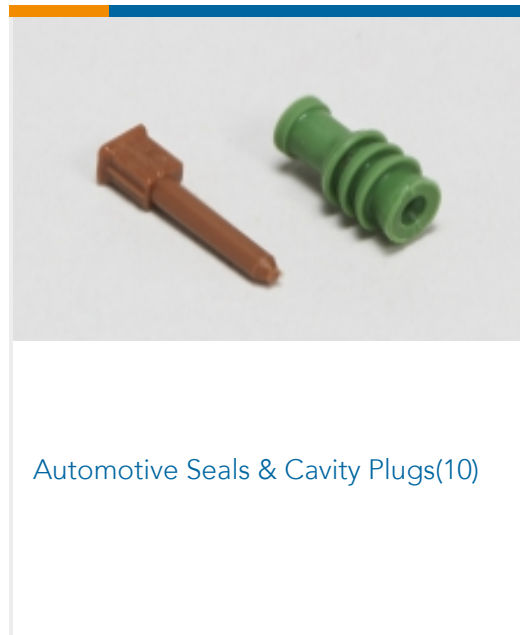

Automotive Seals & Cavity Plugs(10)

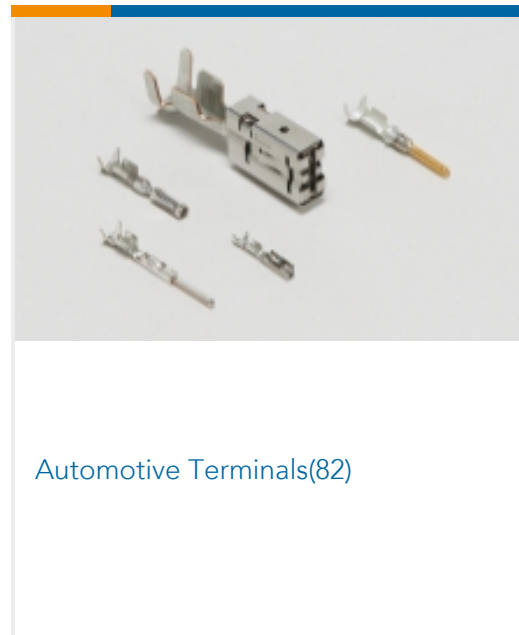

Automotive Terminals(82)

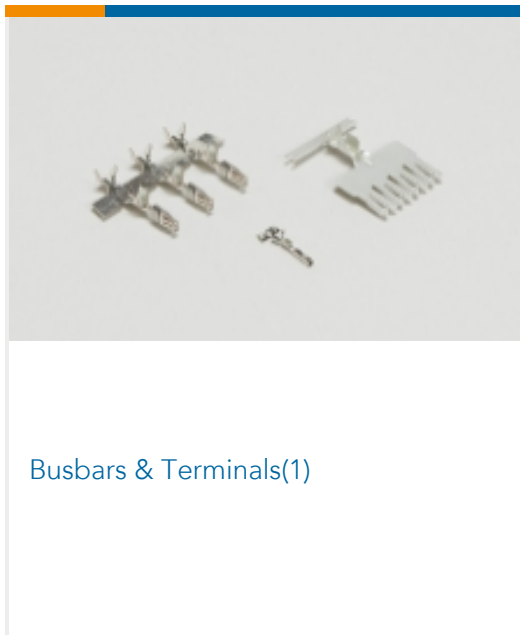

Busbars & Terminals(1)

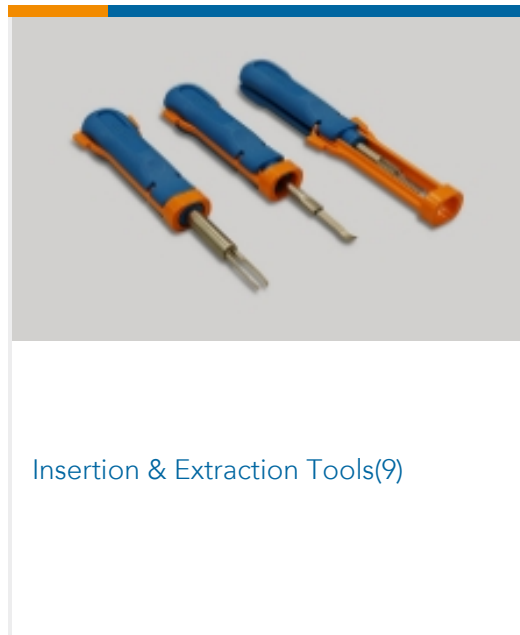

Insertion & Extraction Tools(9)



Module Components(8)

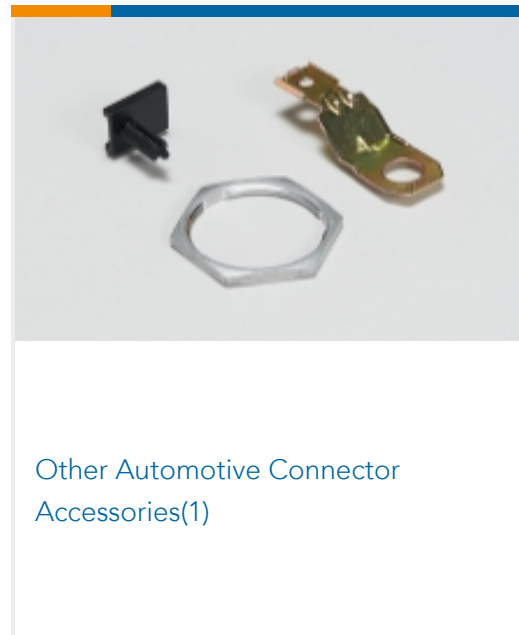

Other Automotive Connector Accessories(1)



PCB Headers & Receptacles(1)

Customers Also Bought



TE Part #DT06-2S
DEUTSCH DT Series Housings & Connectors



TE Part #W2S
DEUTSCH DT WEDGELOCKS

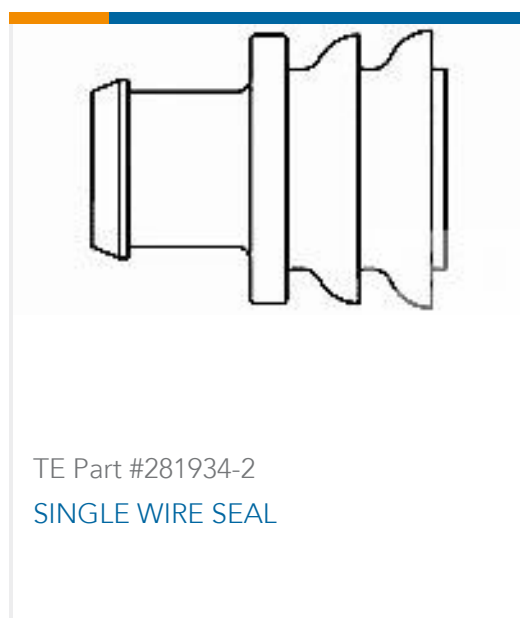

TE Part #281934-2
SINGLE WIRE SEAL



TE Part #0460-202-16141
DEUTSCH SOLID CONTACTS



Documents

Product Drawings

4P JPT CONNECTOR ASSY

English

CAD Files

Customer View Model

[ENG_CVM_CVM_144998-6_A.2d_dxf.zip](#)

English

3D PDF

3D

Customer View Model

[ENG_CVM_CVM_144998-6_A.3d_igs.zip](#)

English

Customer View Model

[ENG_CVM_CVM_144998-6_A.3d_stp.zip](#)

English

By downloading the CAD file I accept and agree to the [Terms and Conditions](#) of use.

Datasheets & Catalog Pages

Timer Interconnection System

English

Product Specifications

Product Specification

French

Instruction Sheets

CONNECTEURS JPT ETANCHES A ETRIER POUR CONNEXIONS FIL A FIL PRECONISAT

English

Instruction Sheet (non U.S.)

English