

1452409-1 ✓ ACTIVE

AMP | MCON 1.2mm, MCON Interconnection System

TE Internal #: 1452409-1

Automotive Connector Locks & Position Assurance, TPA (Terminal Position Assurance), Red, Wire-to-Board, PA GF, MCON Interconnection System

[View on TE.com >](#)



Connectors > Automotive Connectors > Connector Accessories > Locks & Position Assurance

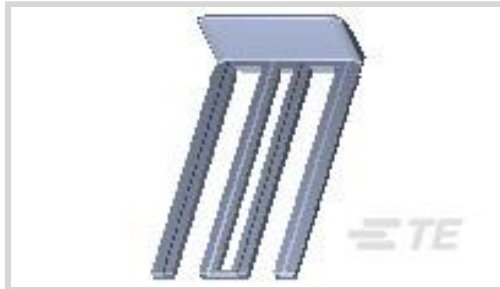

Connector & Contact Retention Accessory Type: **TPA (Terminal Position Assurance)**

Primary Product Color: **Red**

Connector System: **Wire-to-Board**

Primary Product Material: **PA GF**

Operating Temperature Range: **-40 – 140 °C [ -40 – 284 °F ]**

## Features

### Product Type Features

Connector & Contact Retention Accessory Type	TPA (Terminal Position Assurance)
Connector System	Wire-to-Board

### Body Features

Primary Product Color	Red
Primary Product Material	PA GF

### Usage Conditions

Operating Temperature Range	-40 – 140 °C[-40 – 284 °F]
-----------------------------	----------------------------

### Industry Standards

UL Flammability Rating	UL 94HB
------------------------	---------

### Packaging Features

Packaging Quantity	3000
Packaging Method	Carton

### Other

Serviceable	Yes
-------------	-----

## Product Compliance

[For compliance documentation, visit the product page on TE.com>](#)



EU RoHS Directive 2011/65/EU	Compliant
EU ELV Directive 2000/53/EC	Compliant
China RoHS 2 Directive MIIT Order No 32, 2016	No Restricted Materials Above Threshold
EU REACH Regulation (EC) No. 1907/2006	Current ECHA Candidate List: JUNE 2022 (224) Candidate List Declared Against: JAN 2022 (223) SVHC > Threshold: Not Yet Reviewed
Halogen Content	BFR/CFR/PVC Free, but Br/Cl >900 ppm in other sources.
Solder Process Capability	Not applicable for solder process capability

Product Compliance Disclaimer

This information is provided based on reasonable inquiry of our suppliers and represents our current actual knowledge based on the information they provided. This information is subject to change. The part numbers that TE has identified as EU RoHS compliant have a maximum concentration of 0.1% by weight in homogenous materials for lead, hexavalent chromium, mercury, PBB, PBDE, DBP, BBP, DEHP, DIBP, and 0.01% for cadmium, or qualify for an exemption to these limits as defined in the Annexes of Directive 2011/65/EU (RoHS2). Finished electrical and electronic equipment products will be CE marked as required by Directive 2011/65/EU. Components may not be CE marked. Additionally, the part numbers that TE has identified as EU ELV compliant have a maximum concentration of 0.1% by weight in homogenous materials for lead, hexavalent chromium, and mercury, and 0.01% for cadmium, or qualify for an exemption to these limits as defined in the Annexes of Directive 2000/53/EC (ELV). Regarding the REACH Regulation, the information TE provides on SVHC in articles for this part number is based on the latest European Chemicals Agency (ECHA) 'Guidance on requirements for substances in articles' posted at this URL: <https://echa.europa.eu/guidance-documents/guidance-on-reach>

## Compatible Parts



TE Part # CAT-M4595-CH8172  
MCON, CONNECTOR HOUSING



TE Part # 1-1452415-5  
58 POS FEMALE ASSY CONNECTOR



TE Part # 1-1563172-4  
58POS, MIXED,REC HSG,ASSY



TE Part # 4-1563172-6  
58POS, MIXED,REC HSG,ASSY



TE Part # 5-1563172-4  
58POS, MIXED,REC HSG,ASSY



TE Part # 7-1563172-7  
58POS, MIXED,REC HSG,ASSY



TE Part # 8-1452415-9  
58 POS MIXED, MCON CONNECTOR



TE Part # 9-1452415-1  
58 POS MIXED, MCON CONNECTOR



### Also in the Series | MCON 1.2mm

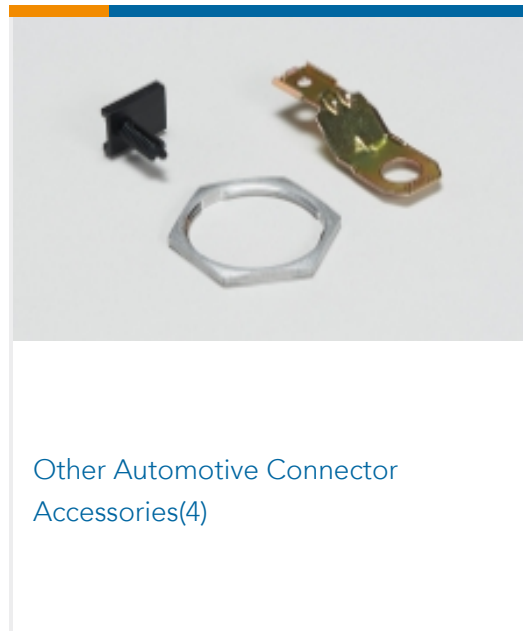
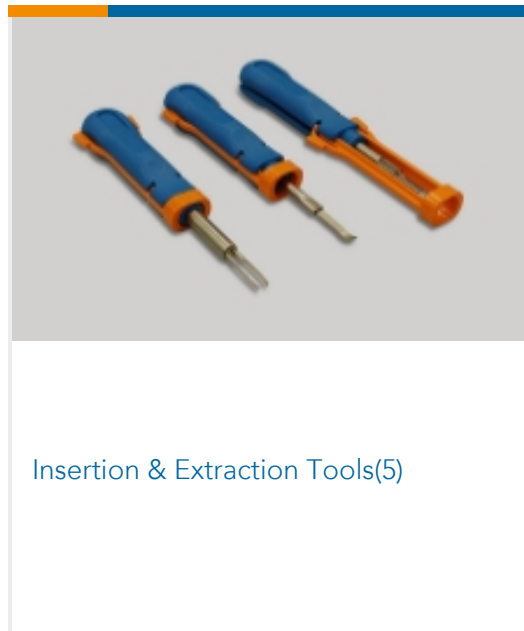
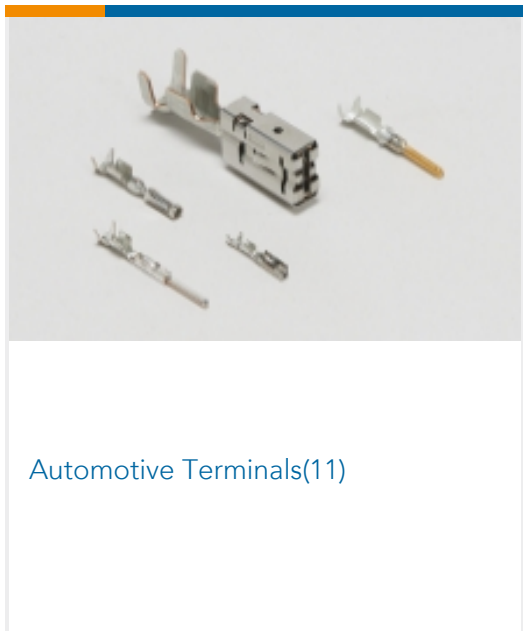
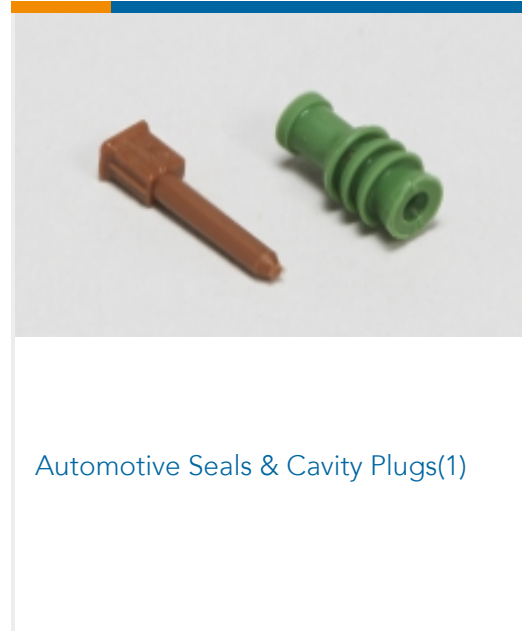
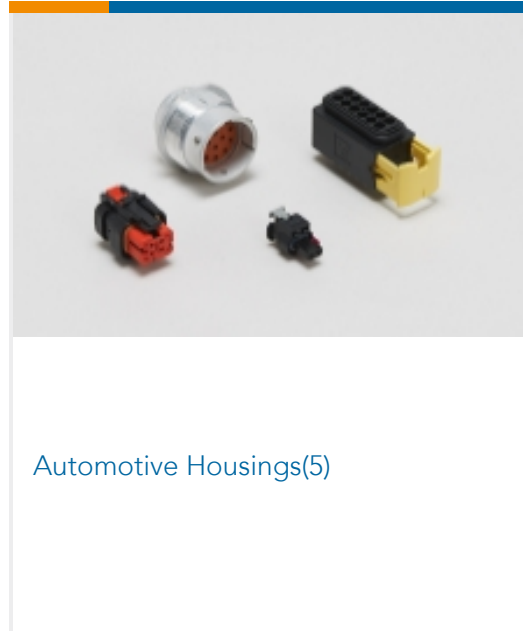
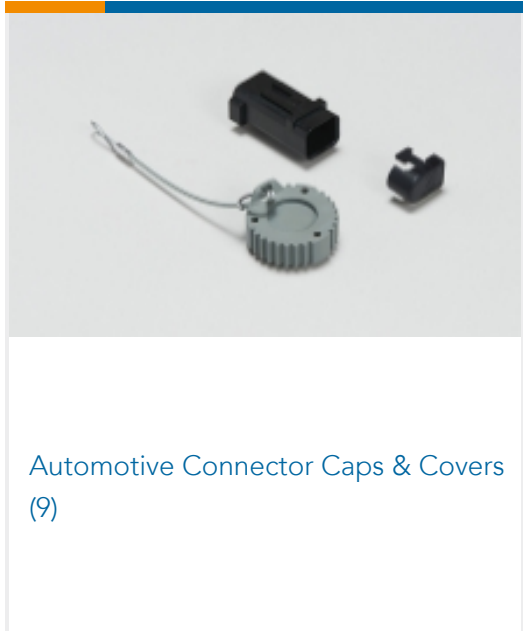

### Also in the Series | MCON Interconnection System

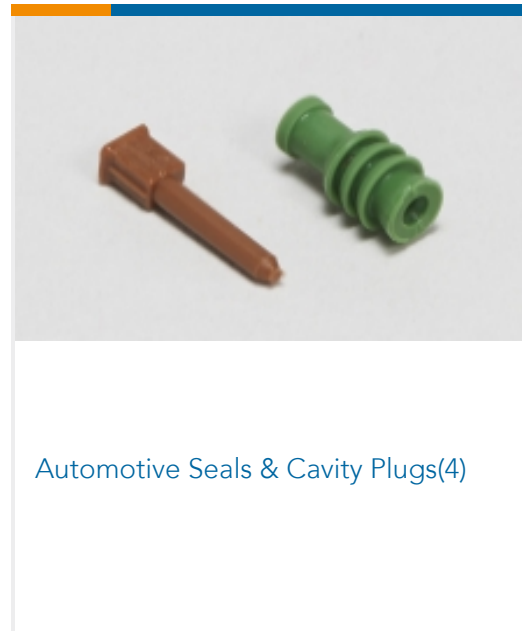
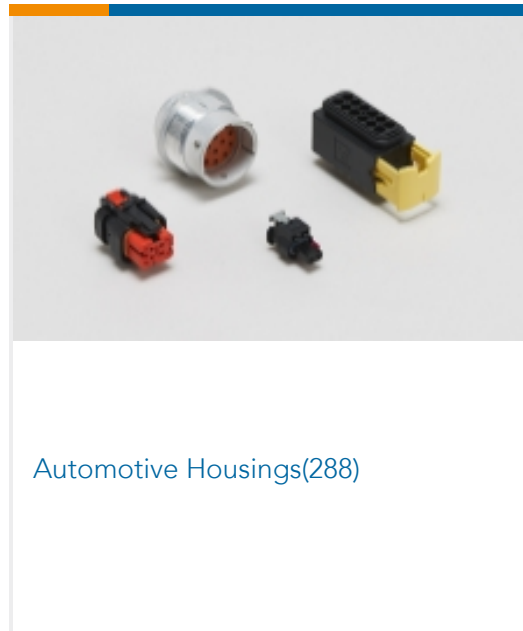

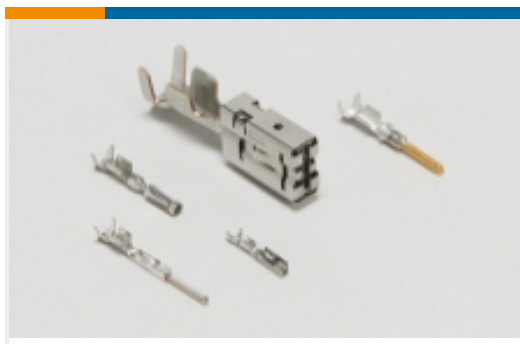

Automotive Terminals(113)



Insertion & Extraction Tools(31)



Other Automotive Connector Accessories(6)

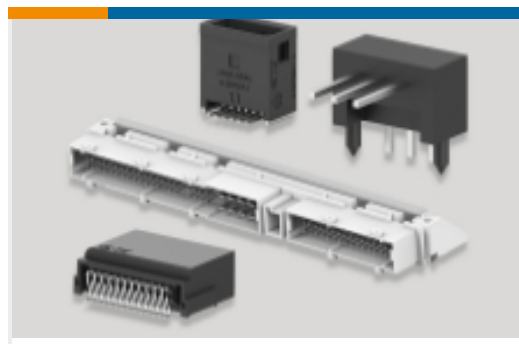

PCB Headers & Receptacles(1)

## Customers Also Bought



TE Part #350707-1  
UMNL SPLIT PIN 20-14 PTPBR L/P



TE Part #1011-273-0205  
BKSHL, 2P, BLK, PLG, ST, NW 7.5/8.5

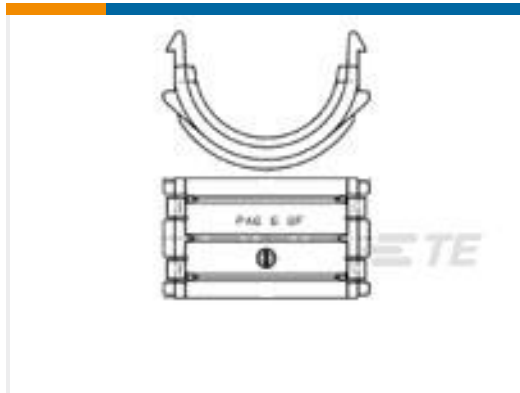

TE Part #964732-1  
BEFESTIGUNGSSCHALE



TE Part #1-1418469-1  
6POS,AMP MCP1.5K,REC. HSG,CODA



TE Part #1-927771-1  
JPT REC 2.8 Contact SRC Au



TE Part #1-1718484-4  
CARRIER FOR RECEPTACLE INSERTS



TE Part #HDP26-24-19PN-L017  
PLG, 19P, BLK, N, RNG, 12/16, P

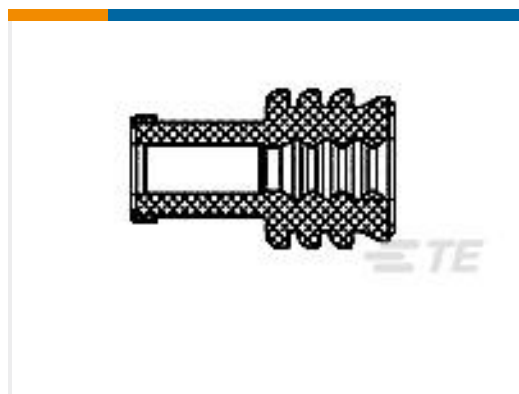

TE Part #1393457-4  
V23540M1000Z110=DICHTTULLE (F1



TE Part #1879980-1  
MINI SUPERSEAL CONNECTOR

## Documents

### Product Drawings

[2-NDRY F.58P CONNECTOR](#)

English

### CAD Files

[Customer View Model](#)

[ENG\\_CVM\\_CVM\\_1452409-1\\_C.2d\\_dxf.zip](#)

English

[3D PDF](#)



3D

Customer View Model

[ENG\\_CVM\\_CVM\\_1452409-1\\_C.3d\\_igs.zip](#)

English

Customer View Model

[ENG\\_CVM\\_CVM\\_1452409-1\\_C.3d\\_stp.zip](#)

English

By downloading the CAD file I accept and agree to the [Terms and Conditions](#) of use.

---

### Product Specifications

[Appl. Spec. for 154 pos.Connector \( 96 pos. and 58 pos.\)](#)

English

[Product Specification](#)

English

---

### Product Environmental Compliance

[Product Compliance](#)

English

[Product Compliance](#)

English