

141708-1 ✓ ACTIVE

AMPMODU | AMPMODU IV/V

TE Internal #: 141708-1

Connector Contact, Receptacle, Wire-to-Board, 24 – 20 AWG Wire Size, 404 – 1022 CMA Wire Size, .205 – .518 mm² Wire Size, Gold, Bag, AMPMODU IV/V

[View on TE.com >](#)



Connectors > PCB Connectors > Wire-to-Board Connectors > Wire-to-Board Connector Contacts

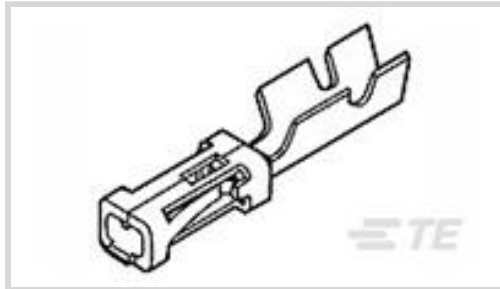

Contact Type: **Receptacle**

Connector System: **Wire-to-Board**

Wire Size: **.205 – .518 mm²**

Features

Product Type Features

Applied Pressure	Intermediate
Connector System	Wire-to-Board
Sealable	No
Connector & Contact Terminates To	Wire & Cable

Configuration Features

Compatible With Wire & Cable Type	Discrete Wire
-----------------------------------	---------------

Contact Features

Mating Square Post Dimension	.64 mm[.025 in]
Contact Retention Within Housing	With
Wire Contact Termination Area Plating Material	Tin
	30 μin
Contact Orientation	Straight
Contact Base Material	Phosphor Bronze
Contact Type	Receptacle
Contact Mating Area Plating Material	Gold
Contact Current Rating (Max)	4.4 A

Termination Features

Termination Method to Wire & Cable	Crimp
------------------------------------	-------

Mechanical Attachment

--	--



Contact Retention Type Within Housing	Locking Lance
---------------------------------------	---------------

Wire Insulation Support	With
-------------------------	------

Dimensions

Accepts Wire Insulation Diameter Range	1.21 mm[.048 in]
--	------------------

Wire Size	.205 – .518 mm ²
-----------	-----------------------------

Usage Conditions

Operating Temperature Range	-65 – 105 °C[-85 – 221 °F]
-----------------------------	----------------------------

Operation/Application

Circuit Application	Signal
---------------------	--------

Industry Standards

Glow Wire Rating	Standard Part - Not Glow Wire
------------------	-------------------------------

Packaging Features

Packaging Quantity	200
--------------------	-----

Packaging Method	Bag
------------------	-----

Other

Comment	For 0.63 mm "Round" Post and 0.63 x 0.63 mm "Square" Post., Reduced crimp width at 0.14 mm ² -. Please contact AMP.
---------	--

Product Compliance

[For compliance documentation, visit the product page on TE.com>](#)

EU RoHS Directive 2011/65/EU	Compliant
------------------------------	-----------

EU ELV Directive 2000/53/EC	Compliant
-----------------------------	-----------

China RoHS 2 Directive MIIT Order No 32, 2016	No Restricted Materials Above Threshold
---	---

















EU REACH Regulation (EC) No. 1907/2006	Current ECHA Candidate List: JUNE 2022 (224) Candidate List Declared Against: JAN 2022 (223) SVHC > Threshold: Not Yet Reviewed
--	--

Halogen Content	Low Halogen - Br, Cl, F, I < 900 ppm per homogenous material. Also BFR/CFR/PVC Free
-----------------	---

Solder Process Capability	Not applicable for solder process capability
---------------------------	--

This information is provided based on reasonable inquiry of our suppliers and represents our current actual knowledge based on the information they provided. This information is subject to change. The part numbers that TE has identified as EU RoHS compliant have a maximum concentration of 0.1% by weight in homogenous materials for lead, hexavalent chromium, mercury, PBB, PBDE, DBP, BBP, DEHP, DIBP, and 0.01% for cadmium, or qualify for an exemption to these limits as defined in the Annexes of Directive 2011/65/EU (RoHS2). Finished electrical and electronic equipment products will be CE marked as required by Directive 2011/65/EU. Components may not be CE marked. Additionally, the part numbers that TE has identified as EU ELV compliant have a maximum concentration of 0.1% by weight in homogenous materials for lead, hexavalent chromium, and mercury, and 0.01% for cadmium, or qualify for an exemption to these limits as defined in the Annexes of Directive 2000/53/EC (ELV). Regarding the REACH Regulation, the information TE provides on SVHC in articles for this part number is based on the latest European Chemicals Agency (ECHA) 'Guidance on requirements for substances in articles' posted at this URL: <https://echa.europa.eu/guidance-documents/guidance-on-reach>

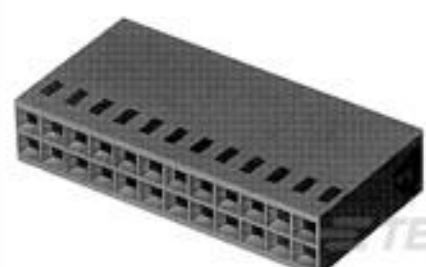
Compatible Parts

 <p>TE Part # 843473-1 EXTRACTION TOOL</p>	 <p>TE Part # 925370-5 MOD IV REC HSG 2X5P</p>	 <p>TE Part # 925366-8 MOD 4 REC.HSG 1X08P</p>	 <p>TE Part # 926476-3 MOD 4 HSG</p>
 <p>TE Part # 925370-6 MOD.IV REC HSG, 2X6P</p>	 <p>TE Part # 926476-8 MOD 4 HSG</p>	 <p>TE Part # 926475-3 03P MODU 4 HSG.S.R.</p>	 <p>TE Part # 926475-4 MOD 4 HSG</p>
 <p>TE Part # 925369-3 MOD 4 REC.HSG 1X03P</p>	 <p>TE Part # 925369-6 MOD 4 REC.HSG 1X06P</p>	 <p>TE Part # 925370-8 MOD IV REC HSG, 2X8P</p>	 <p>TE Part # 925370-2 MOD IV REC HSG, 2X2P</p>
 <p>TE Part # 925369-2 MOD 4 REC.HSG 1X02P</p>	 <p>TE Part # 925370-4 MOD IV REC HSG 2X4 POS</p>	 <p>TE Part # 925367-4 MOD 4 REC.HSG 2X04P</p>	 <p>TE Part # 925369-5 MOD 4 REC.HSG 1X05P</p>

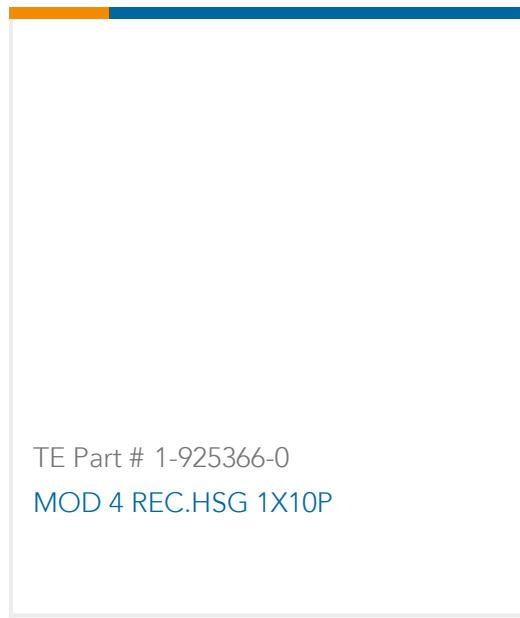

Also in the Series | AMPMODU IV/V

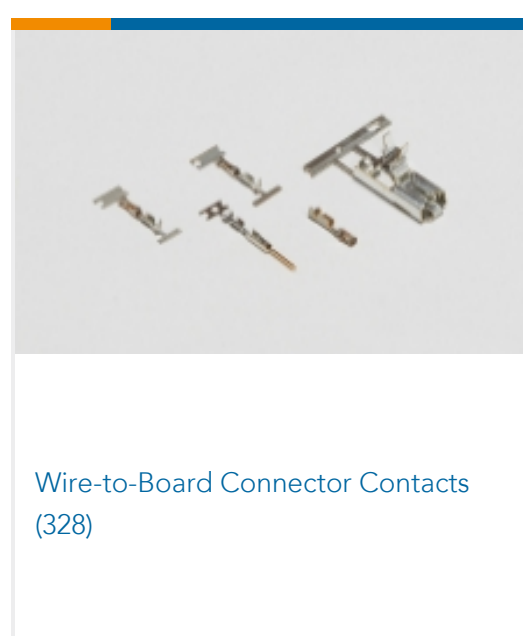
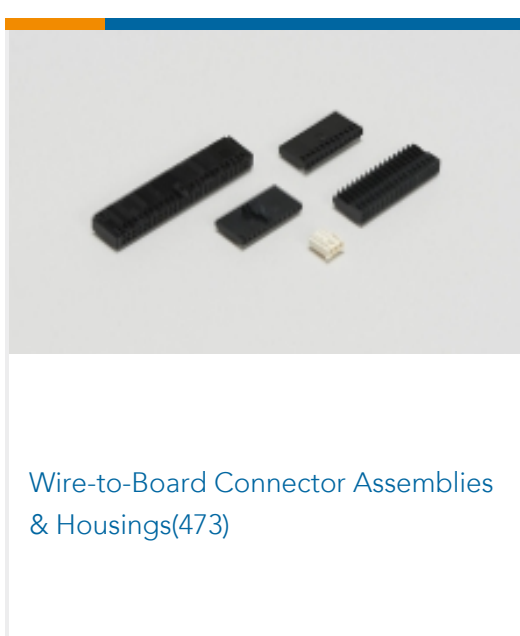
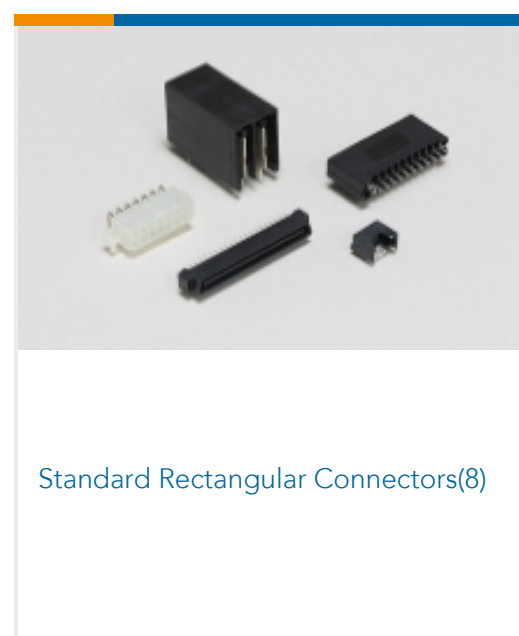
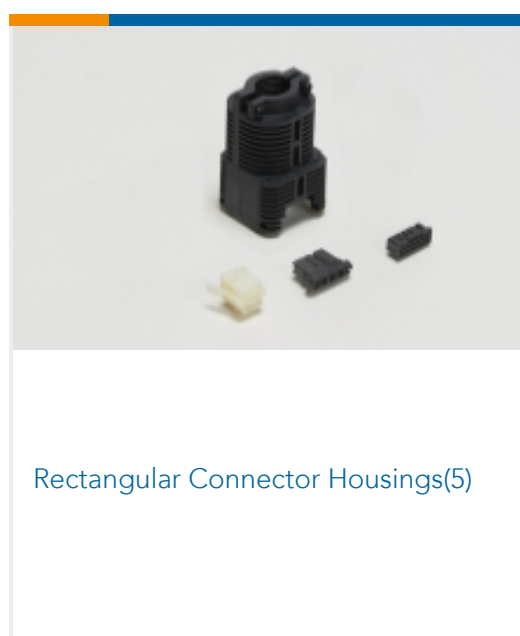
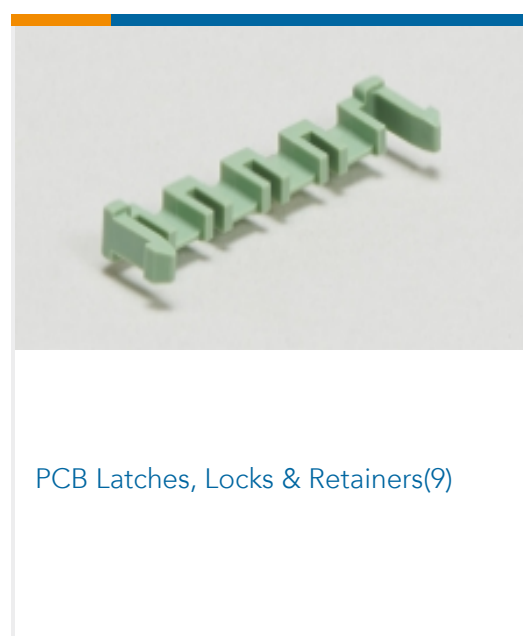
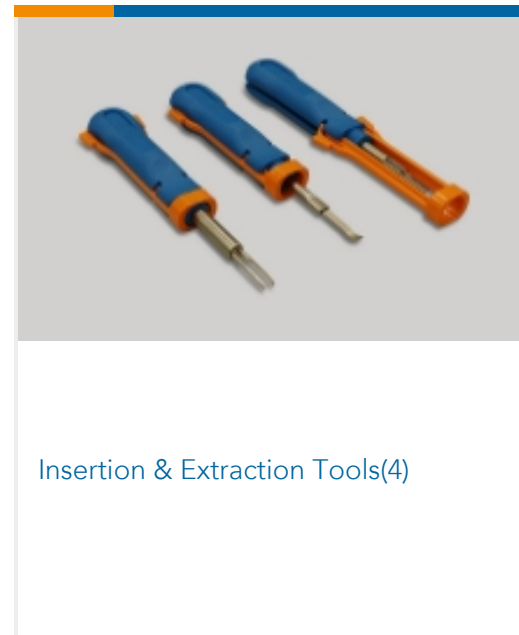
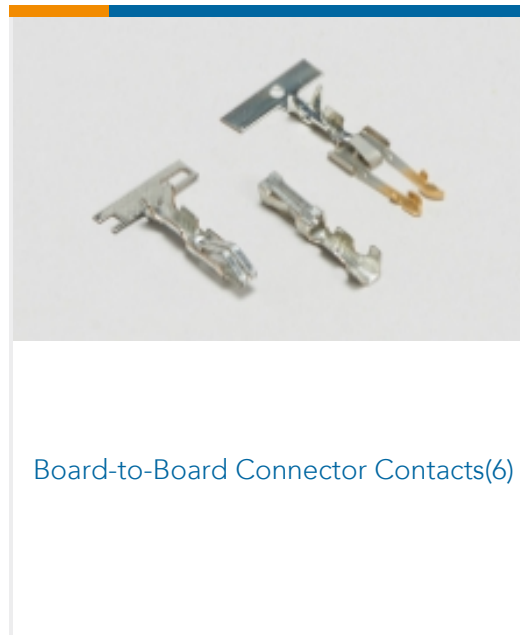
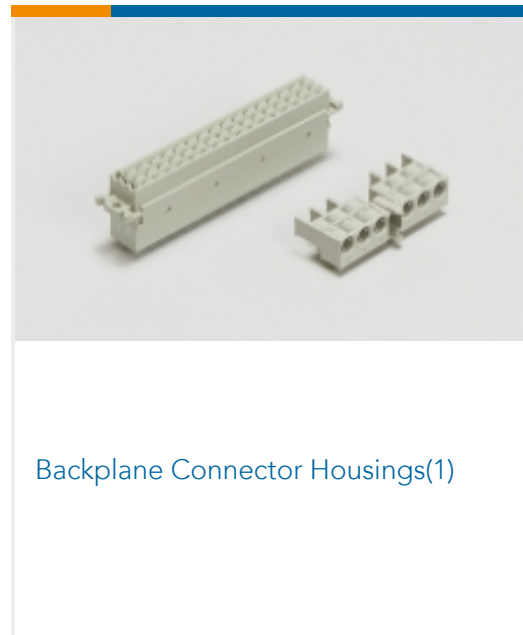
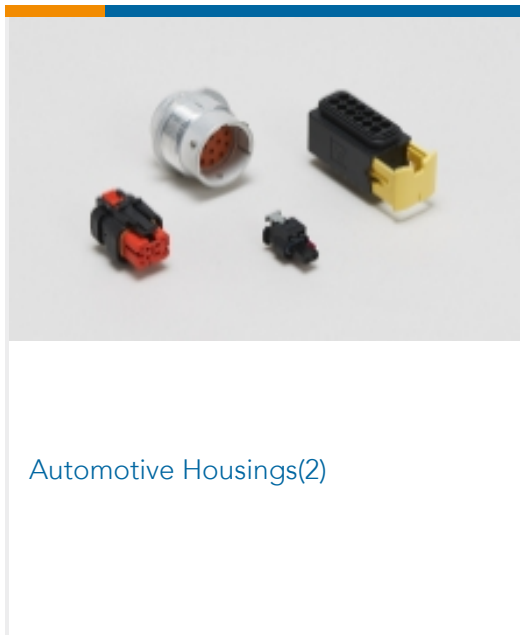

Customers Also Bought



TE Part #6-2176231-4
3522 4K3 1% 3W



TE Part #1-87631-6
20 MODIV HSG DR MRKD .100 POL

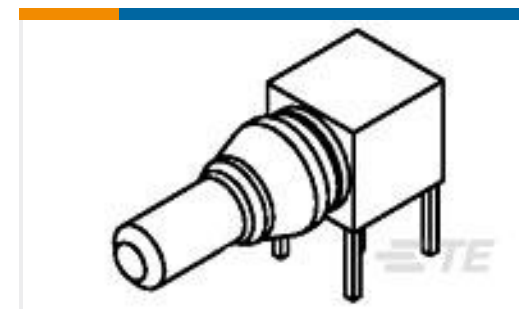

TE Part #1-1393589-8
C42334A 347A102=HS-STECKER



TE Part #925370-5
MOD IV REC HSG 2X5P.



TE Part #925367-4
MOD 4 REC.HSG 2X04P



TE Part #3-826953-6
36P MOD2 STIFT LEI



TE Part #5-103960-7
2X8 MTE RCPT SR LATCH .100CL

Documents

Product Drawings

[MOD-4 REC.CONT.SCP.](#)

English

CAD Files

Customer View Model

[ENG_CVM_CVM_141708-1_G.2d_dxf.zip](#)

English

3D PDF

3D

Customer View Model

[ENG_CVM_CVM_141708-1_G.3d_igs.zip](#)

English

Customer View Model

[ENG_CVM_CVM_141708-1_G.3d_stp.zip](#)

English

By downloading the CAD file I accept and agree to the [Terms and Conditions](#) of use.

Datasheets & Catalog Pages

[AMPMODU Interconnection System](#)

[AMPMODU Interconnection System](#)

English

Product Environmental Compliance

[Product Compliance](#)

English

[Product Compliance](#)



English