

1469265-9 ✓ ACTIVE

Z-PACK 2mm HM

TE Internal #: 1469265-9

Backplane Guide Hardware, Guide Pin Module, Z-PACK 2mm HM

[View on TE.com >](#)



Connectors > PCB Connectors > Backplane Connectors > Backplane Guide Hardware

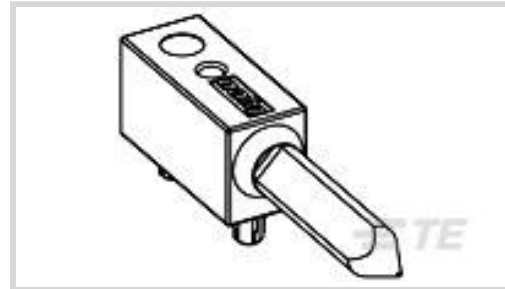

Backplane Guide Hardware Type: **Guide Pin Module**

Features

Product Type Features

Backplane Guide Hardware Type	Guide Pin Module
-------------------------------	------------------

Configuration Features

PCB Mount Orientation	Right Angle
-----------------------	-------------

Body Features

Guide Component Plating Material Finish Process	Chromate Conversion Coating
Guide Component Base Material	Zinc Alloy Die Casting

Termination Features

Compatible With Backplane Interface Type	MULTI GIG RT2J
--	----------------

Mechanical Attachment

Mating Alignment Type	Keyed
Mating Alignment	With
Guide Hardware	Without

Packaging Features

Packaging Quantity	60
Packaging Method	Package

Product Compliance

[For compliance documentation, visit the product page on TE.com>](#)

EU RoHS Directive 2011/65/EU	Compliant
EU ELV Directive 2000/53/EC	Compliant
China RoHS 2 Directive MIIT Order No 32, 2016	No Restricted Materials Above Threshold
EU REACH Regulation (EC) No. 1907/2006	

Current ECHA Candidate List: JUNE 2022
(224)

Candidate List Declared Against: JAN 2022
(223)

SVHC > Threshold:
Not Yet Reviewed

Halogen Content

Low Halogen - Br, Cl, F, I < 900 ppm per homogenous material. Also BFR/CFR/PVC Free

Solder Process Capability

Not applicable for solder process capability

Product Compliance Disclaimer

This information is provided based on reasonable inquiry of our suppliers and represents our current actual knowledge based on the information they provided. This information is subject to change. The part numbers that TE has identified as EU RoHS compliant have a maximum concentration of 0.1% by weight in homogenous materials for lead, hexavalent chromium, mercury, PBB, PBDE, DBP, BBP, DEHP, DIBP, and 0.01% for cadmium, or qualify for an exemption to these limits as defined in the Annexes of Directive 2011/65/EU (RoHS2). Finished electrical and electronic equipment products will be CE marked as required by Directive 2011/65/EU. Components may not be CE marked. Additionally, the part numbers that TE has identified as EU ELV compliant have a maximum concentration of 0.1% by weight in homogenous materials for lead, hexavalent chromium, and mercury, and 0.01% for cadmium, or qualify for an exemption to these limits as defined in the Annexes of Directive 2000/53/EC (ELV). Regarding the REACH Regulation, the information TE provides on SVHC in articles for this part number is based on the latest European Chemicals Agency (ECHA) 'Guidance on requirements for substances in articles' posted at this URL: <https://echa.europa.eu/guidance-documents/guidance-on-reach>

Compatible Parts



TE Part # 5223957-3
UPM GUIDE MODULE

Also in the Series | Z-PACK 2mm HM



Backplane Coding Keys(60)

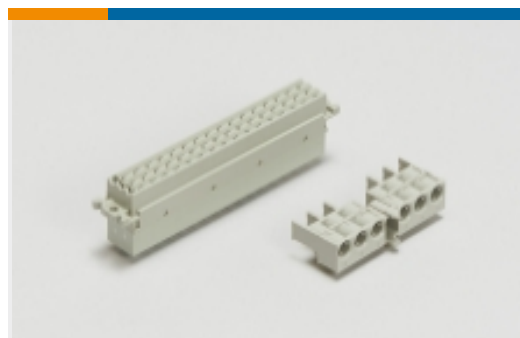

Backplane Connector Housings(4)



Backplane Guide Hardware(37)

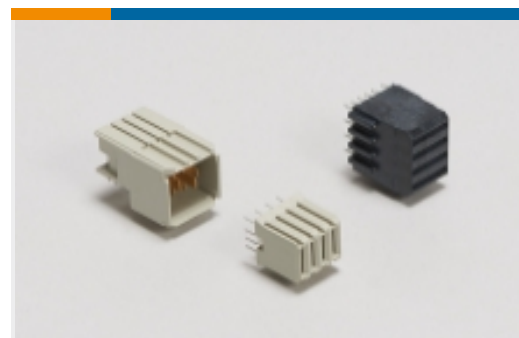

Backplane Power Connectors(6)



Board-to-Board Connector Contacts(2)

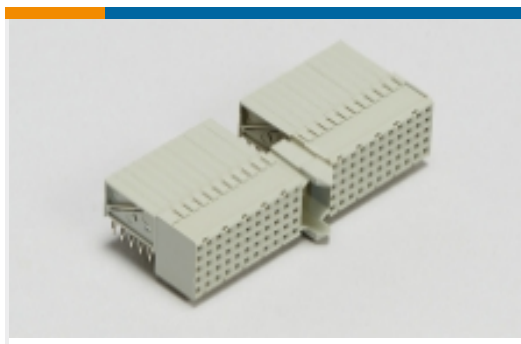

Hard Metric Backplane Connectors (269)

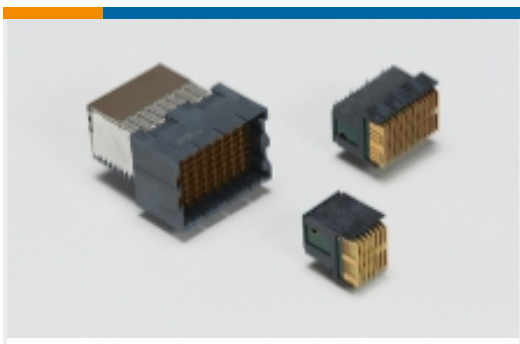

High Speed Backplane Connectors(1)



Insertion & Extraction Tools(2)

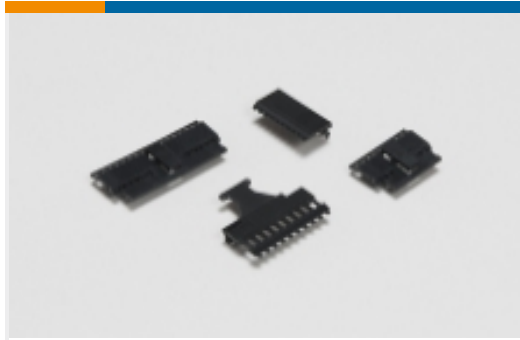

PCB Connector Covers(4)



PCB Connector Shrouds(39)



PCB Ferrules & Shields(19)



PCB Latches, Locks & Retainers(1)



Rectangular Power Connectors(87)

Customers Also Bought



TE Part #DT06-2S
DEUTSCH DT Series Housings & Connectors



TE Part #W2S
DEUTSCH DT WEDGELOCKS

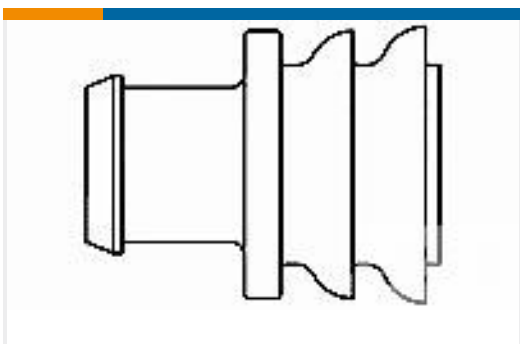

TE Part #281934-2
SINGLE WIRE SEAL



TE Part #0460-202-16141
DEUTSCH SOLID CONTACTS



TE Part #282104-1
AMP SUPERSEAL 1.5MM,
CONNECTOR HOUSING



TE Part #114017-ZZ
SEALING PLUG, SIZE 12/16, WHT

Documents



CAD Files

Customer View Model

[ENG_CVM_CVM_1469265-9_A.2d_dxf.zip](#)

English

3D PDF

3D

Customer View Model

[ENG_CVM_CVM_1469265-9_A.3d_igs.zip](#)

English

Customer View Model

[ENG_CVM_CVM_1469265-9_A.3d_stp.zip](#)

English

By downloading the CAD file I accept and agree to the [Terms and Conditions](#) of use.

Datasheets & Catalog Pages

[2_PIECE_POWER_CONNECTORS_qrg_4-1773458-1](#)

English

Product Specifications

[Engineering Report](#)

English

Product Environmental Compliance

[MD_1469265-9_052120181247_dmtec](#)

English

[MD_1469265-9_052120181247_dmtec](#)

English