



1.5/2.8 Connector System

TE Internal #: 1326032-6

Automotive Terminals, Receptacle, Mating Tab Width 2.8 mm [.11 in], Tab Thickness .031 in [.8 mm], 12 AWG Wire Size, 1.5/2.8 Connector System

[View on TE.com >](#)

Terminals & Splices > Automotive Terminals > 1.5/2.8 CONNECTOR SYSTEM, RECPT AND TAB

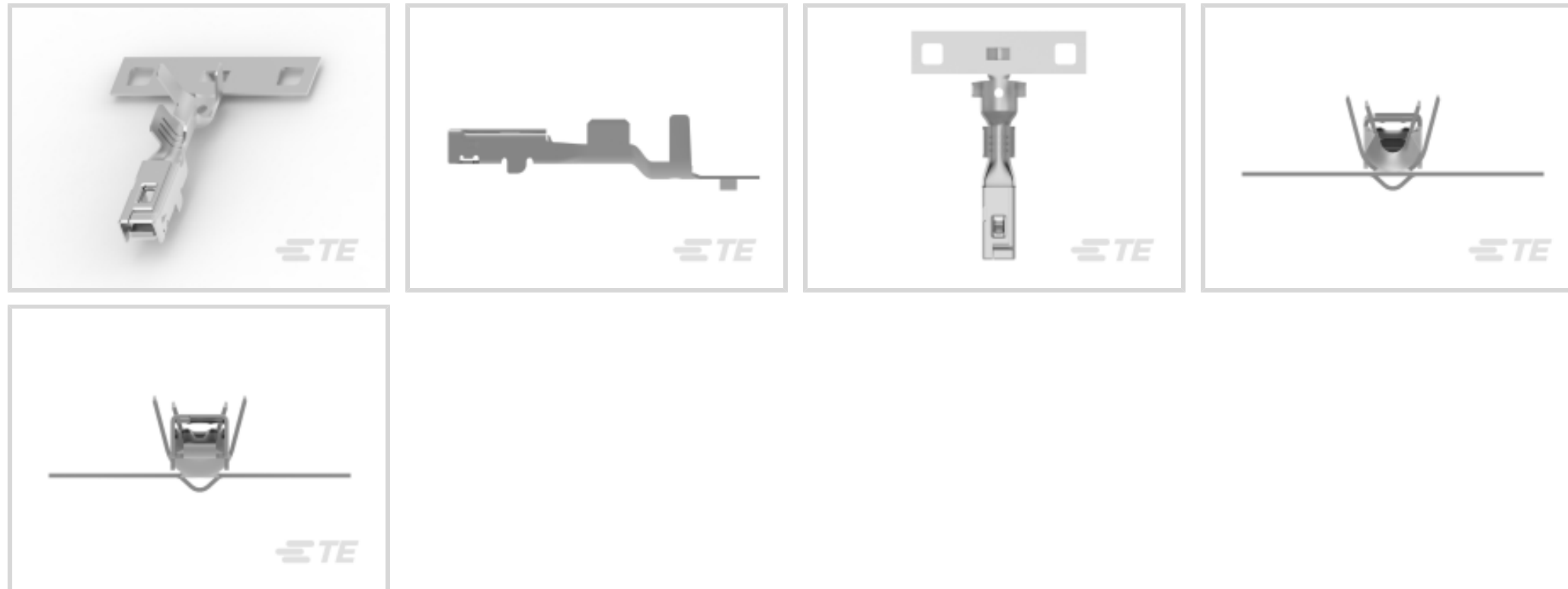

Terminal Type: **Receptacle**

Mating Tab Width: **2.8 mm [.11 in]**

Mating Tab Thickness: **.8 mm [.031 in]**

Wire Size: **3 mm²**

[All 1.5/2.8 CONNECTOR SYSTEM, RECPT AND TAB \(40\)](#)

Features

Product Type Features

Receptacle Style	180°
Sealable	Yes

Body Features

Terminal Seal Type	Single Wire Seal (SWS)
--------------------	------------------------

Contact Features

Contact Size	2.8mm
Contact Fabrication	Stamped & Formed
Crimp Type	F-Crimp
Terminal Type	Receptacle
Mating Tab Width	2.8 mm[.11 in]
Mating Tab Thickness	.8 mm[.031 in]
Interface Plating	Tin (Sn)
Contact Termination Area Plating Material	Tin (Sn)



Termination Features

Termination Method to Wire & Cable	Crimp
Product Terminates To	Wire

Dimensions

Wire Size	3 mm ²
Wire Size Search	12 AWG
Wire Insulation Diameter	3.1 – 3.3 mm [.122 – .13 in]

Usage Conditions

Insulation Option	Uninsulated
Operating Temperature (Max)	80 °C, 85 °C, 90 °C, 100 °C, 105 °C, 110 °C, 120 °C, 125 °C [176 °F][185 °F][194 °F][212 °F][221 °F][230 °F][248 °F][257 °F]
Operating Temperature Range	-40 – 125 °C [-40 – 257 °F]

Packaging Features

Packaging Method	Package
Packaging Quantity	2000

Product Compliance

[For compliance documentation, visit the product page on TE.com>](#)









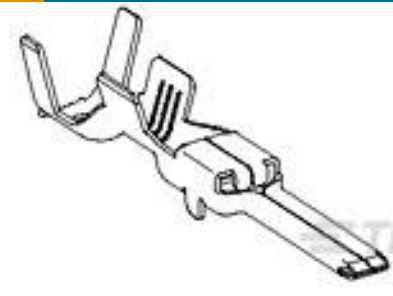

EU RoHS Directive 2011/65/EU	Compliant
EU ELV Directive 2000/53/EC	Compliant
China RoHS 2 Directive MIIT Order No 32, 2016	No Restricted Materials Above Threshold
EU REACH Regulation (EC) No. 1907/2006	Current ECHA Candidate List: JAN 2022 (223) Candidate List Declared Against: JAN 2022 (223) Does not contain REACH SVHC
Halogen Content	Low Halogen - Br, Cl, F, I < 900 ppm per homogenous material. Also BFR/CFR/PVC Free
Solder Process Capability	Not applicable for solder process capability

Product Compliance Disclaimer

This information is provided based on reasonable inquiry of our suppliers and represents our current actual knowledge based on the information they provided. This information is subject to change. The part numbers that TE has identified as EU RoHS compliant have a maximum concentration of 0.1% by weight in homogenous materials for lead, hexavalent chromium, mercury, PBB, PBDE, DBP, BBP, DEHP, DIBP, and 0.01% for cadmium, or qualify for an exemption to these limits as defined in the Annexes of Directive 2011/65/EU (RoHS2). Finished electrical and electronic equipment products will be CE marked as required by Directive 2011/65/EU. Components may not be CE marked. Additionally, the part

numbers that TE has identified as EU ELV compliant have a maximum concentration of 0.1% by weight in homogenous materials for lead, hexavalent chromium, and mercury, and 0.01% for cadmium, or qualify for an exemption to these limits as defined in the Annexes of Directive 2000/53/EC (ELV). Regarding the REACH Regulation, the information TE provides on SVHC in articles for this part number is based on the latest European Chemicals Agency (ECHA) 'Guidance on requirements for substances in articles' posted at this URL: <https://echa.europa.eu/guidance-documents/guidance-on-reach>

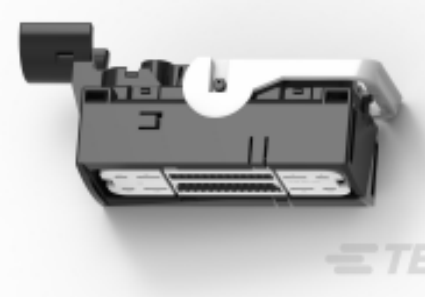
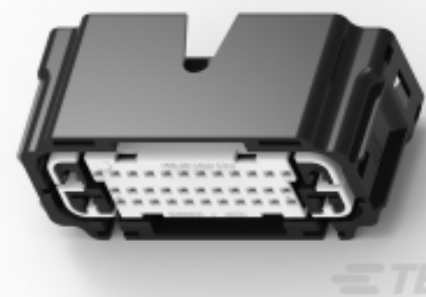
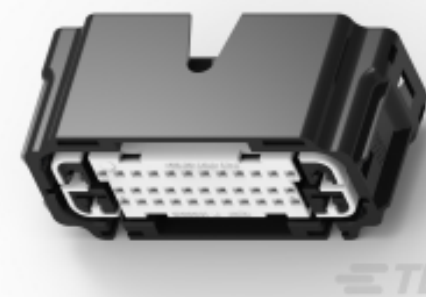
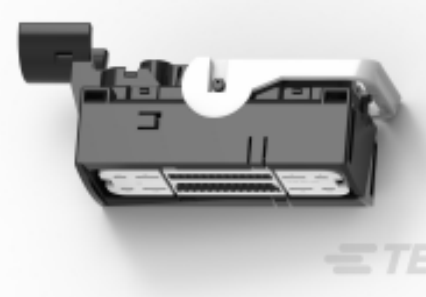
Compatible Parts

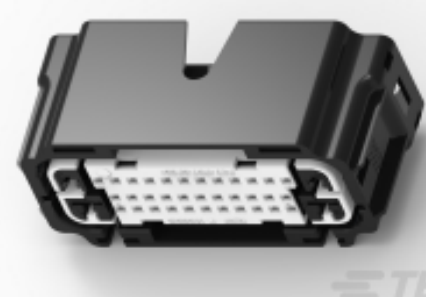
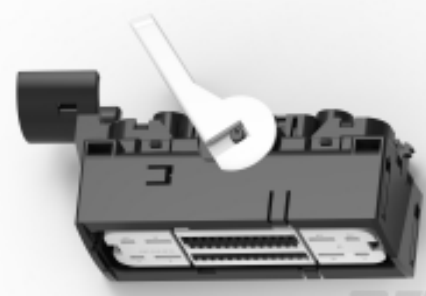
 <p>TE Part # 1-1326031-1 2.8MM BLD,SEAL,12AWG</p>	 <p>TE Part # 1438841-1 34WAY IN-LINE PLUG ASSY, INDEX A</p>	 <p>TE Part # 1732175-1 2+5 Sealed Connector Ass'y</p>	 <p>TE Part # 1732175-2 2+5 Sealed Connector Ass'y</p>
 <p>TE Part # 1732175-3 2+5 Sealed Connector Ass'y</p>	 <p>TE Part # 4-2203654-6 34WAY IN-LINE PLUG ASSY, INDEX A</p>	 <p>TE Part # 1-1326328-2 46P Plug Assy,EBC440,RightH,2Slot, No2.8</p>	 <p>TE Part # 1456570-6 SUB-ASSY,PLUG,2.8/6.3,38 WAY,ABS</p>
 <p>TE Part # 1-1326327-1 46P PLUG ASSY,EBC440,RIGHT H, 1SLOT,NO2.8</p>	 <p>TE Part # 1-1456570-6 SUB-ASSY,PLUG,2.8/6.3,38 WAY,ABS</p>	 <p>TE Part # 1456570-8 SUB-ASSY,PLUG,2.8/6.3,38 WAY,ABS</p>	 <p>TE Part # 2-1326327-8 46P PLUG ASSY,EBC440,RIGHT H, 1SLOT,NO2.8</p>
 <p>TE Part # 2-1456570-3 SUB-ASSY,PLUG,2.8/6.3,38 WAY,ABS</p>	 <p>TE Part # 2-1456570-4 SUB-ASSY,PLUG,2.8/6.3,38 WAY,ABS</p>	 <p>TE Part # 5-1326339-0 46P PLUG ASSY,EBC440,LEFT H,2S</p>	

Also in the Series | [1.5/2.8 Connector System](#)



Automotive Connector Caps & Covers (6)



Automotive Housings(30)



Automotive Terminals(52)



Insertion & Extraction Tools(1)



Other Automotive Connector Accessories(1)

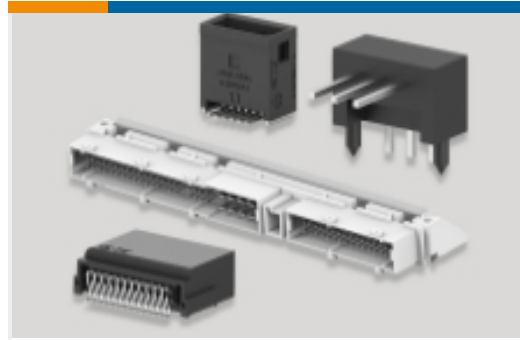

PCB Headers & Receptacles(1)

Customers Also Bought

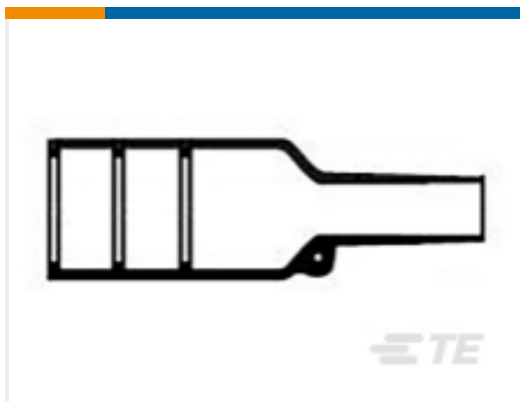

TE Part #CV7361-000
Bulbous Heat Shrink Boots: Lipped, Straight



TE Part #CV7369-000
Bulbous Heat Shrink Boots: Lipped, Right Angle



TE Part #1326031-1
2.8MM BLD,SEAL,22AWG



TE Part #1-1718644-5
3POS, MCON 1.2 LL REC SEALED

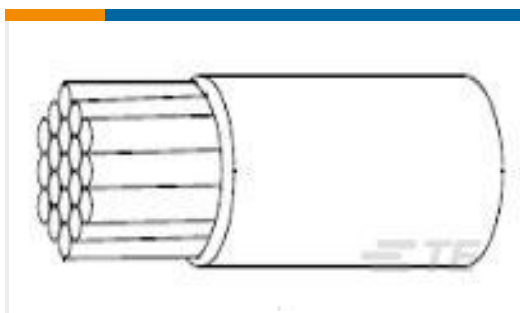

TE Part #8511673001
55M0414-30-9



TE Part #9166473001
TR16-35-0

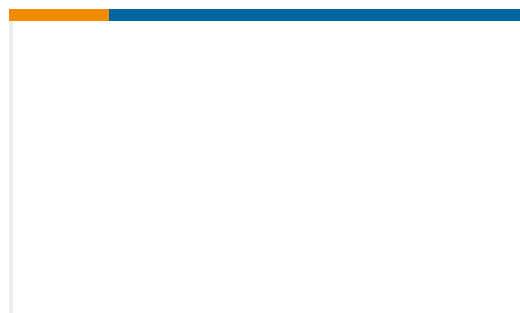

TE Part #EG4836-000
203W301-25L-G02-0



TE Part #EK2807-000
223W601-25L-0

Documents

Product Drawings
2.8MM RECP,SEAL,12AWG

English

CAD Files

3D PDF

3D

Customer View Model

ENG_CVM_CVM_1326032-6_K.2d_dxf.zip



English

Customer View Model

[ENG_CVM_CVM_1326032-6_K.3d_igs.zip](#)

English

Customer View Model

[ENG_CVM_CVM_1326032-6_K.3d_stp.zip](#)

English

By downloading the CAD file I accept and agree to the [Terms and Conditions](#) of use.

Product Specifications

[Application Specification](#)

English

Product Environmental Compliance

[Product Compliance](#)

English

[Product Compliance](#)

English