

1241978-1 ✓ ACTIVE

AMP | Junior Power Timer

TE Internal #: 1241978-1

Automotive Terminals, Receptacle, Mating Tab Width 2.8 mm [.11 in], Tab Thickness .031 in [.8 mm], 13 – 11 AWG Wire Size, Junior Power Timer

[View on TE.com >](#)



Terminals & Splices > Automotive Terminals > TIMER, RECEPTACLE AND TAB



Terminal Type: **Receptacle**

Mating Tab Width: **2.8 mm [.11 in]**

Mating Tab Thickness: **.8 mm [.031 in]**

Terminal Transmits: **25 – 40 A (Power)**

Wire Size: **13 – 11 AWG**

[All TIMER, RECEPTACLE AND TAB \(346\)](#)

### Features

#### Product Type Features

Sealable	No
Primary Locking Feature	Locking Lance

#### Contact Features

Contact Size	2.8mm
Contact Fabrication	Stamped & Formed
Typical Current Rating	30 A
Crimp Type	F-Crimp
Terminal Type	Receptacle
Mating Tab Width	2.8 mm[.11 in]
Mating Tab Thickness	.8 mm[.031 in]
Interface Plating	Tin (Sn)

#### Termination Features

--	--



Termination Method to Wire & Cable	Crimp
Product Terminates To	Wire

### Dimensions

Wire Size	2.5 – 4 mm <sup>2</sup>
Wire Size Search	11 AWG, 12 AWG, 13 AWG
Wire Insulation Diameter	2.7 – 3.7 mm [.106 – .145 in]

### Usage Conditions

Insulation Option	Uninsulated
Operating Temperature (Max)	80 °C, 85 °C, 90 °C, 100 °C, 105 °C, 110 °C, 120 °C, 125 °C, 130 °C [176 °F][185 °F][194 °F][212 °F][221 °F][230 °F][248 °F][257 °F][266 °F]
Operating Temperature Range	-40 – 130 °C [-40 – 266 °F]

### Operation/Application

Compatible With Wire Base Material	Copper
------------------------------------	--------

### Packaging Features

Packaging Method	Reel
Packaging Quantity	2700

### Other

Terminal Transmits	25 – 40 A (Power)
--------------------	-------------------

### Product Compliance

[For compliance documentation, visit the product page on TE.com>](#)

EU RoHS Directive 2011/65/EU	Compliant
EU ELV Directive 2000/53/EC	Compliant
China RoHS 2 Directive MIIT Order No 32, 2016	No Restricted Materials Above Threshold
EU REACH Regulation (EC) No. 1907/2006	Current ECHA Candidate List: JAN 2022 (223) Candidate List Declared Against: JAN 2022 (223) Does not contain REACH SVHC
Halogen Content	Low Halogen - Br, Cl, F, I < 900 ppm per homogenous material. Also BFR/CFR/PVC Free
Solder Process Capability	Not applicable for solder process capability

Product Compliance Disclaimer

This information is provided based on reasonable inquiry of our suppliers and represents our current actual knowledge based on the information they provided. This information is subject to change. The part numbers that TE has identified as EU RoHS compliant have a maximum concentration of 0.1% by weight in homogenous materials for lead, hexavalent chromium, mercury, PBB, PBDE, DBP, BBP, DEHP, DIBP, and 0.01% for cadmium, or qualify for an exemption to these limits as defined in the Annexes of Directive 2011/65/EU (RoHS2). Finished electrical and electronic equipment products will be CE marked as required by Directive 2011/65/EU. Components may not be CE marked. Additionally, the part numbers that TE has identified as EU ELV compliant have a maximum concentration of 0.1% by weight in homogenous materials for lead, hexavalent chromium, and mercury, and 0.01% for cadmium, or qualify for an exemption to these limits as defined in the Annexes of Directive 2000/53/EC (ELV). Regarding the REACH Regulation, the information TE provides on SVHC in articles for this part number is based on the latest European Chemicals Agency (ECHA) 'Guidance on requirements for substances in articles' posted at this URL: <https://echa.europa.eu/guidance-documents/guidance-on-reach>

## Compatible Parts



TE Part # 1-1579007-6  
EXTRACTION TOOL



TE Part # 2305570-1  
TERMINAL CUTTER, SIDE FEED



TE Part # CAT-T4827-CH8172  
TIMER, CONNECTOR HOUSING



TE Part # 2-2266277-1  
OCEAN-2.0-APPLICATOR-S-120F160OV



TE Part # 2-2266277-2  
OCEAN-2.0-APPLICATOR-S-120F160OVA



TE Part # 2266277-1  
OCEAN-2.0-APPLICATOR-S-120F160OV



TE Part # 2266277-2  
OCEAN-2.0-APPLICATOR-S-120F160OVA



TE Part # 7-2266277-1  
OCEAN-2.0-APPLICATOR-S-120F160OV



TE Part # 7-2266277-2  
OCEAN-2.0-APPLICATOR-S-120F160OVA



**KIT**  
TE Part # 7-2266277-7  
OCEAN\_2.0\_SPARE\_PART\_KIT-120F160OV



TE Part # 9-1579008-2  
EXTRACTION TOOL



TE Part # 1-444017-1  
HSG ASSY TIMER 9P



## Also in the Series | Junior Power Timer

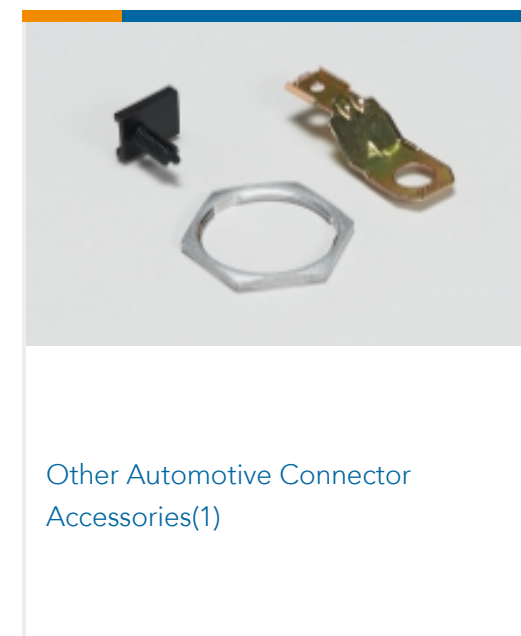
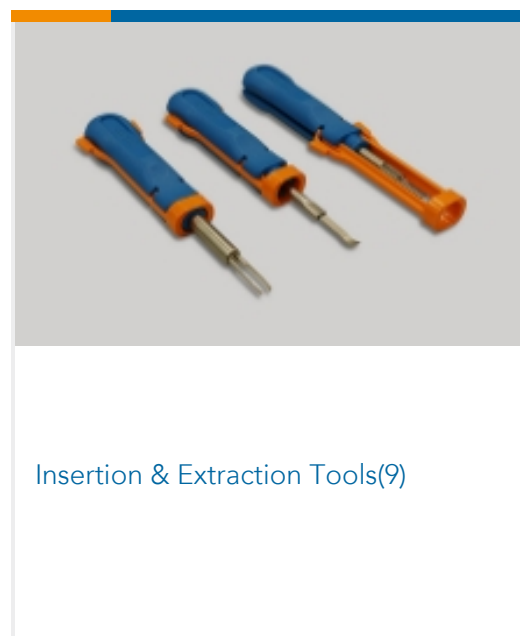
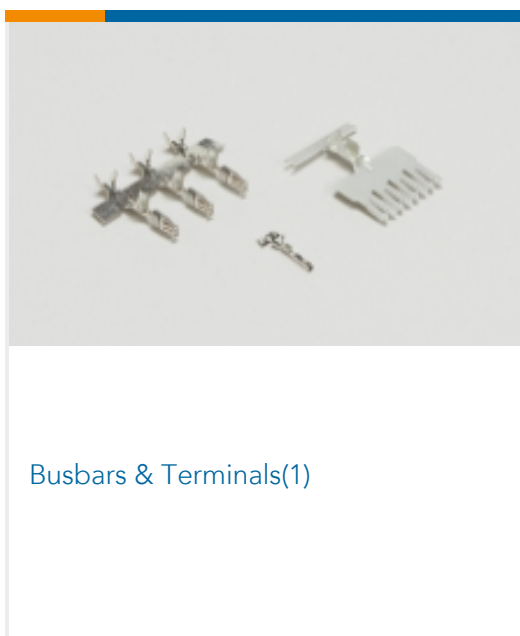
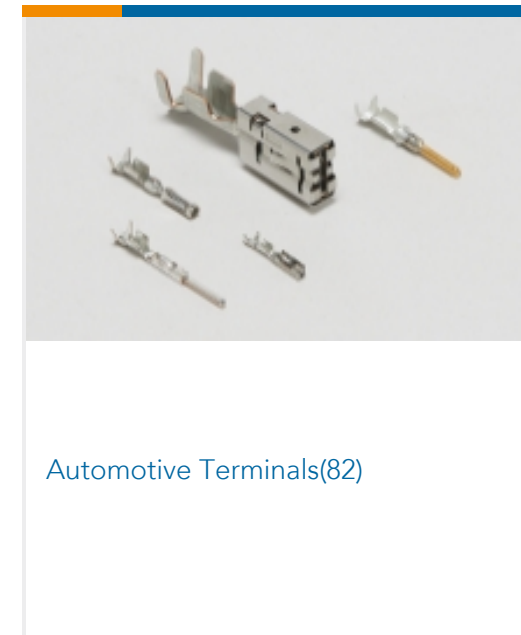
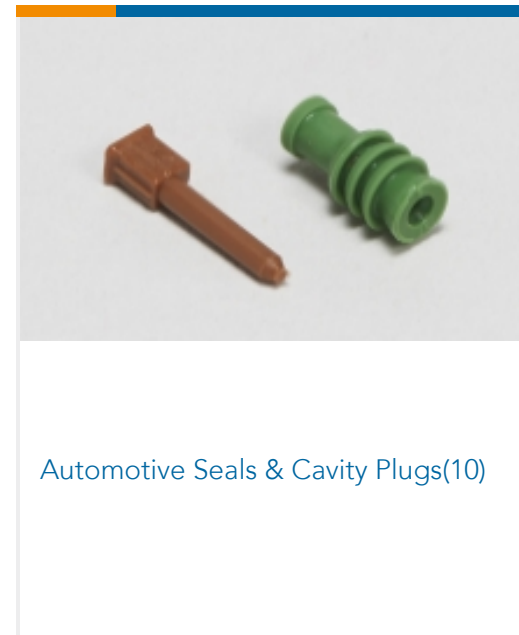
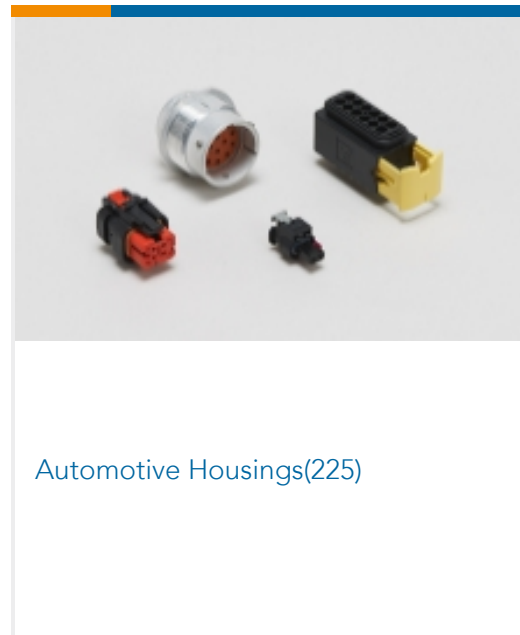
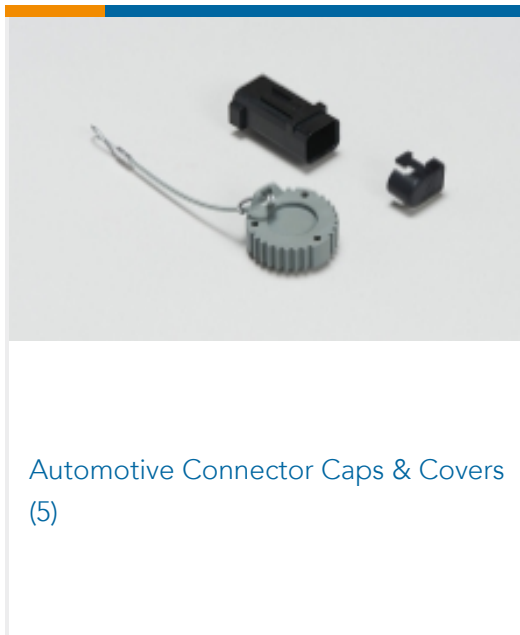

## Customers Also Bought

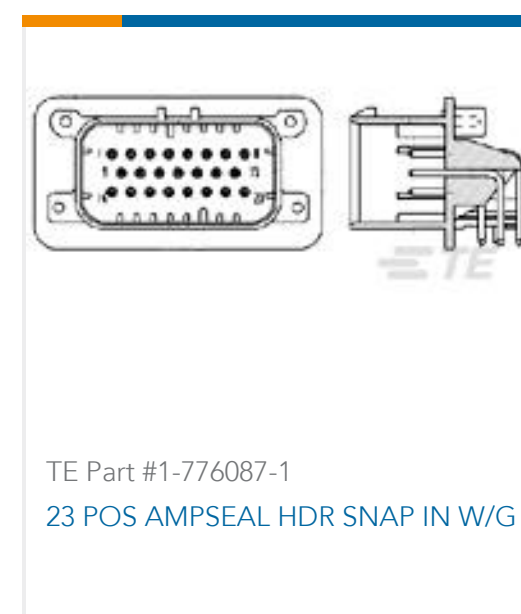





TE Part #1-967622-5  
TIMER, CONNECTOR HOUSING



TE Part #1-962919-1  
TAB 5.8x0.8 CONTACT CS SWS Sn



TE Part #184000-1  
2 POS. PLUG ASSY, KEY A, BLACK

## Documents

### Product Drawings

[JPT A REC 2.8 Contact SRC Sn](#)

English

[JPT A REC 2.8 Contact SRC Sn](#)

English

### CAD Files

Customer View Model

[ENG\\_CVM\\_1241978-1\\_B9.3d\\_igs.zip](#)

English

Customer View Model

[ENG\\_CVM\\_1241978-1\\_B9.3d\\_stp.zip](#)

English

Customer View Model

[ENG\\_CVM\\_1241978-1\\_B9.2d\\_dxf.zip](#)

English

[3D PDF](#)

English

By downloading the CAD file I accept and agree to the [Terms and Conditions](#) of use.

### Datasheets & Catalog Pages

[Timer Interconnection System](#)

English

### Product Specifications

[Application Specification](#)

German

[Application Specification](#)

English