



MQS

TE Internal #: 1379217-2

Housing for Female Terminals, Wire-to-Wire, 5 Position, .1 in / .15 in [2.54 mm / 3.81 mm] Centerline, White, Signal, Cable Mount (Free-Hanging), MQS

[View on TE.com >](#)

Connectors > Automotive Connectors > Connector Housings > MQS, CONNECTOR HOUSING

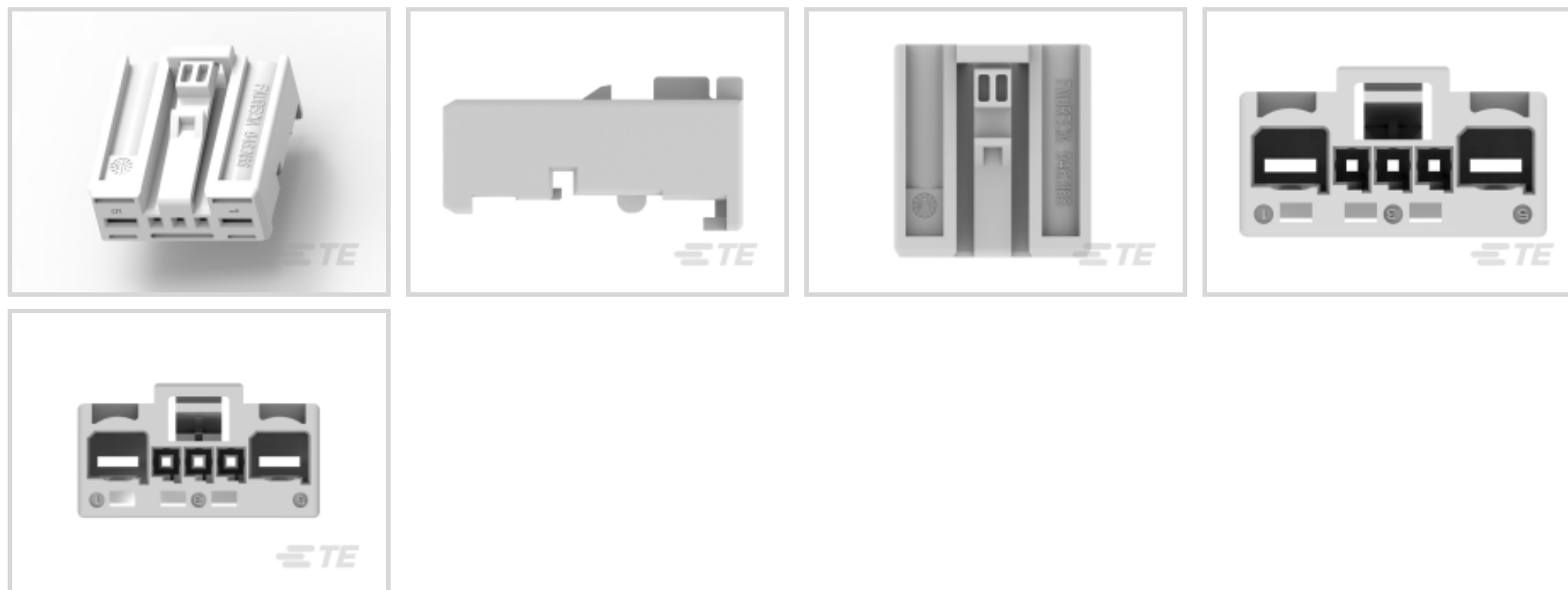

Connector & Housing Type: **Housing for Female Terminals**

Mating Tab Width: **.63 mm, 2.8 mm [.025 in, .11 in]**

Connector System: **Wire-to-Wire**

Number of Positions: **5**

Centerline (Pitch): **2.54 mm, 3.81 mm [.1 in, .15 in]**

[All MQS, CONNECTOR HOUSING \(557\)](#)

Features

Product Type Features

Connector & Housing Shape	Rectangular
Connector & Housing Type	Housing for Female Terminals
Connector System	Wire-to-Wire
Sealable	No
Hybrid Connector	Yes
Primary Locking Feature	On the Terminal

Configuration Features

Number of Positions	5
Number of Rows	1

Electrical Characteristics

Operating Voltage	16 VDC
Nominal Voltage Architecture	12 V



Body Features

Cable Exit Angle	180°
Body Material	PBT GF
Primary Product Color	White
Connector Code	Neutral

Contact Features

Contact Size	.63mm, 2.8mm
Contact Type	Receptacle
Mating Tab Width	.63 mm, 2.8 mm [.025 in][.11 in]

Mechanical Attachment

Mounting Feature	Without
Terminal Position Assurance	Yes
Strain Relief	Without
Mating Alignment Type	Keyed
Mating Alignment	With
Connector Mounting Type	Cable Mount (Free-Hanging)

Housing Features

Centerline (Pitch)	2.54 mm, 3.81 mm [.1 in][.15 in]
--------------------	----------------------------------

Dimensions

Product Width	20.5 mm [.807 in]
Product Length	19 mm [.748 in]
Product Height	10.5 mm [.413 in]
Row-to-Row Spacing	5.5 mm, 7.6 mm [.217 in][.299 in]

Usage Conditions

Operating Temperature (Max)	70 °C, 75 °C, 80 °C, 85 °C, 90 °C, 100 °C [158 °F][167 °F][176 °F][185 °F][194 °F][212 °F]
Operating Temperature Range	-40 – 100 °C [-40 – 212 °F]

Operation/Application

Circuit Application	Signal
---------------------	--------

Industry Standards

UL Flammability Rating	UL 94HB
------------------------	---------



Other

Serviceable	Yes
Connector Position Assurance Capable	No

Product Compliance

[For compliance documentation, visit the product page on TE.com>](#)

EU RoHS Directive 2011/65/EU	Compliant
EU ELV Directive 2000/53/EC	Compliant
China RoHS 2 Directive MIIT Order No 32, 2016	No Restricted Materials Above Threshold
EU REACH Regulation (EC) No. 1907/2006	Current ECHA Candidate List: JAN 2022 (223) Candidate List Declared Against: JUN 2016 (169) SVHC > Threshold: Not Yet Reviewed
Halogen Content	BFR/CFR/PVC Free, but Br/Cl >900 ppm in other sources.
Solder Process Capability	Not reviewed for solder process capability

Product Compliance Disclaimer

This information is provided based on reasonable inquiry of our suppliers and represents our current actual knowledge based on the information they provided. This information is subject to change. The part numbers that TE has identified as EU RoHS compliant have a maximum concentration of 0.1% by weight in homogenous materials for lead, hexavalent chromium, mercury, PBB, PBDE, DBP, BBP, DEHP, DIBP, and 0.01% for cadmium, or qualify for an exemption to these limits as defined in the Annexes of Directive 2011/65/EU (RoHS2). Finished electrical and electronic equipment products will be CE marked as required by Directive 2011/65/EU. Components may not be CE marked. Additionally, the part numbers that TE has identified as EU ELV compliant have a maximum concentration of 0.1% by weight in homogenous materials for lead, hexavalent chromium, and mercury, and 0.01% for cadmium, or qualify for an exemption to these limits as defined in the Annexes of Directive 2000/53/EC (ELV). Regarding the REACH Regulations, TE's information on SVHC in articles for this part number is still based on the European Chemical Agency (ECHA) 'Guidance on requirements for substances in articles' (Version: 2, April 2011), applying the 0.1% weight on weight concentration threshold at the finished product level. TE is aware of the European Court of Justice ruling of September 10th, 2015 also known as O5A (Once An Article Always An Article) stating that, in case of 'complex object', the threshold for a SVHC must be applied to both the product as a whole and simultaneously to each of the articles forming part of its composition. TE has evaluated this ruling based on the new ECHA "Guidance on requirements for substances in articles" (June 2017, version 4.0) and will be updating its statements accordingly.

Compatible Parts



Also in the Series | MQS

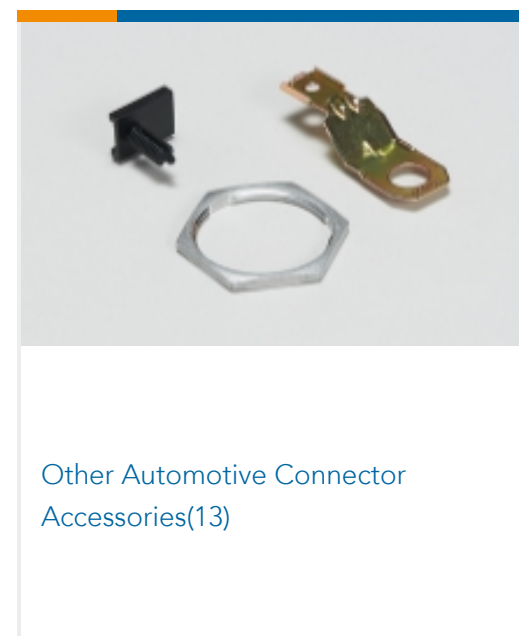
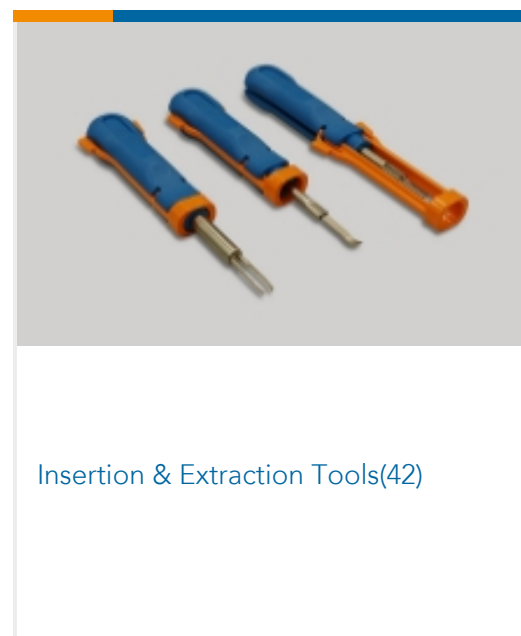
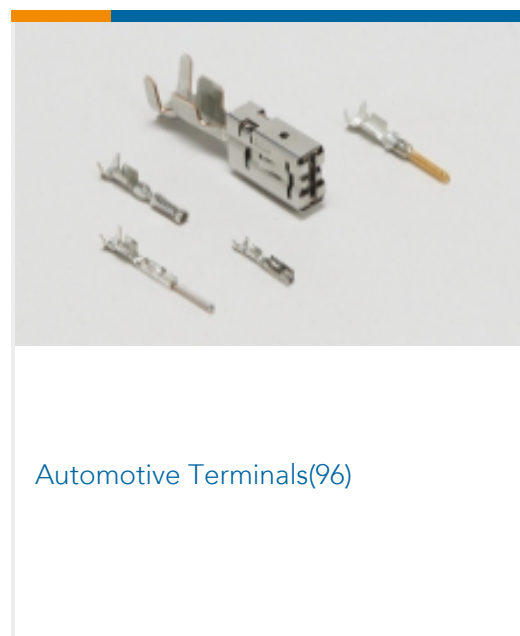
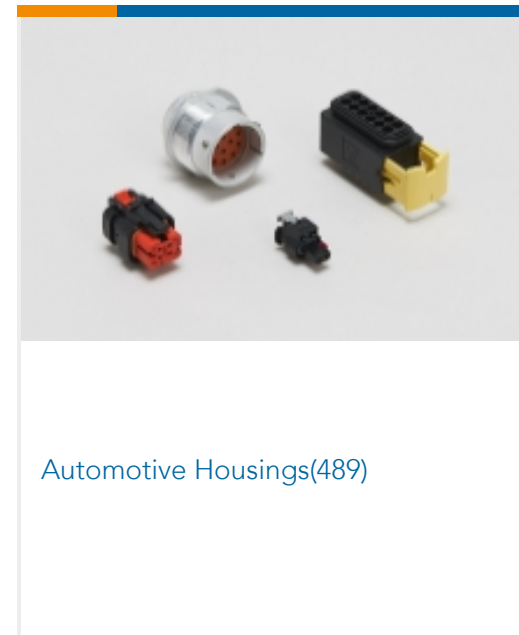
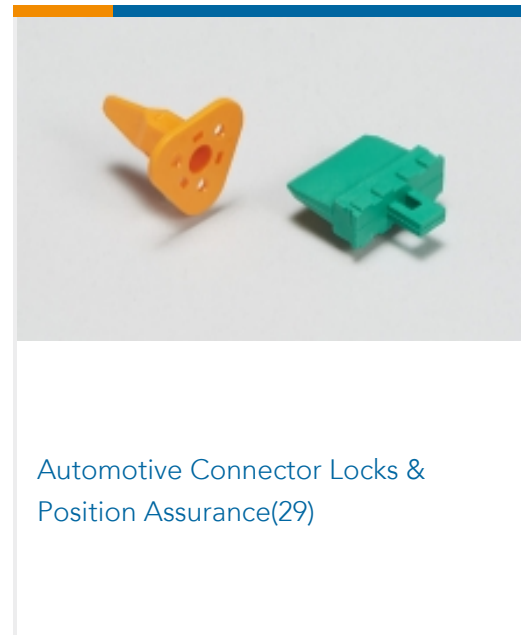
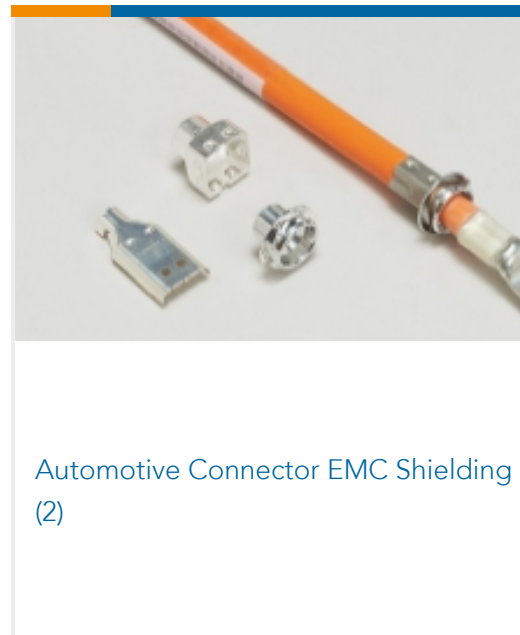

Customers Also Bought

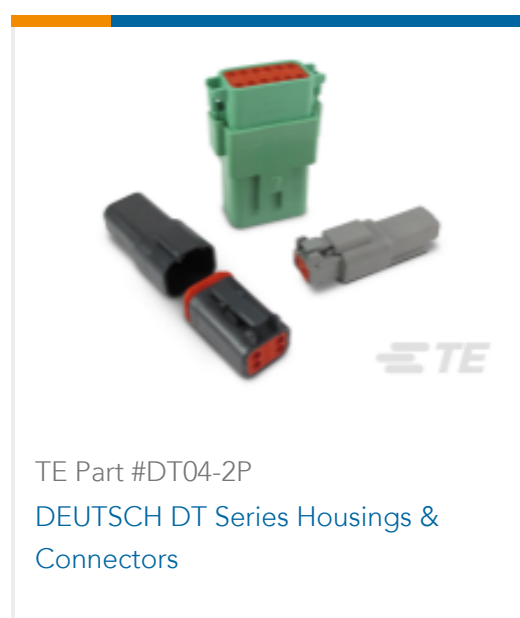
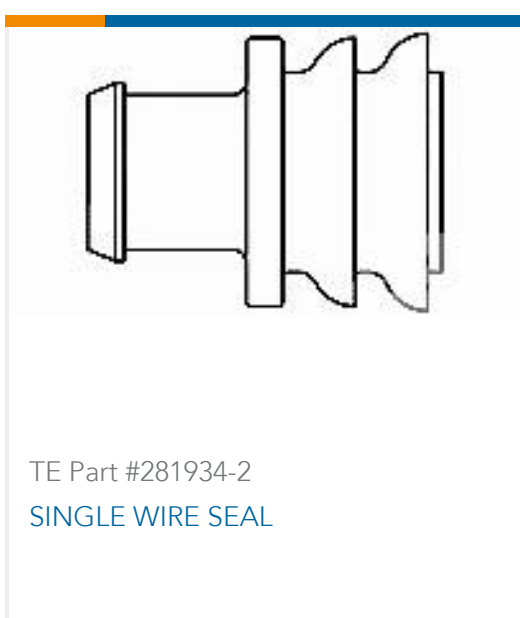



Documents

Product Drawings

5W MPQ+MQS SOC HSG

English

CAD Files

Customer View Model

[ENG_CVM_CVM_1379217-2_A.2d_dxf.zip](#)

English

3D PDF

3D

Customer View Model

[ENG_CVM_CVM_1379217-2_A.3d_igs.zip](#)

English

Customer View Model

[ENG_CVM_CVM_1379217-2_A.3d_stp.zip](#)

English

By downloading the CAD file I accept and agree to the [Terms and Conditions](#) of use.

Datasheets & Catalog Pages

Micro Quadlok Interconnection System (MQS)

English

Product Specifications

2 WAY MPQ + 3 WAY MQS SOCKET HOUSING

English

Product Specification

English