

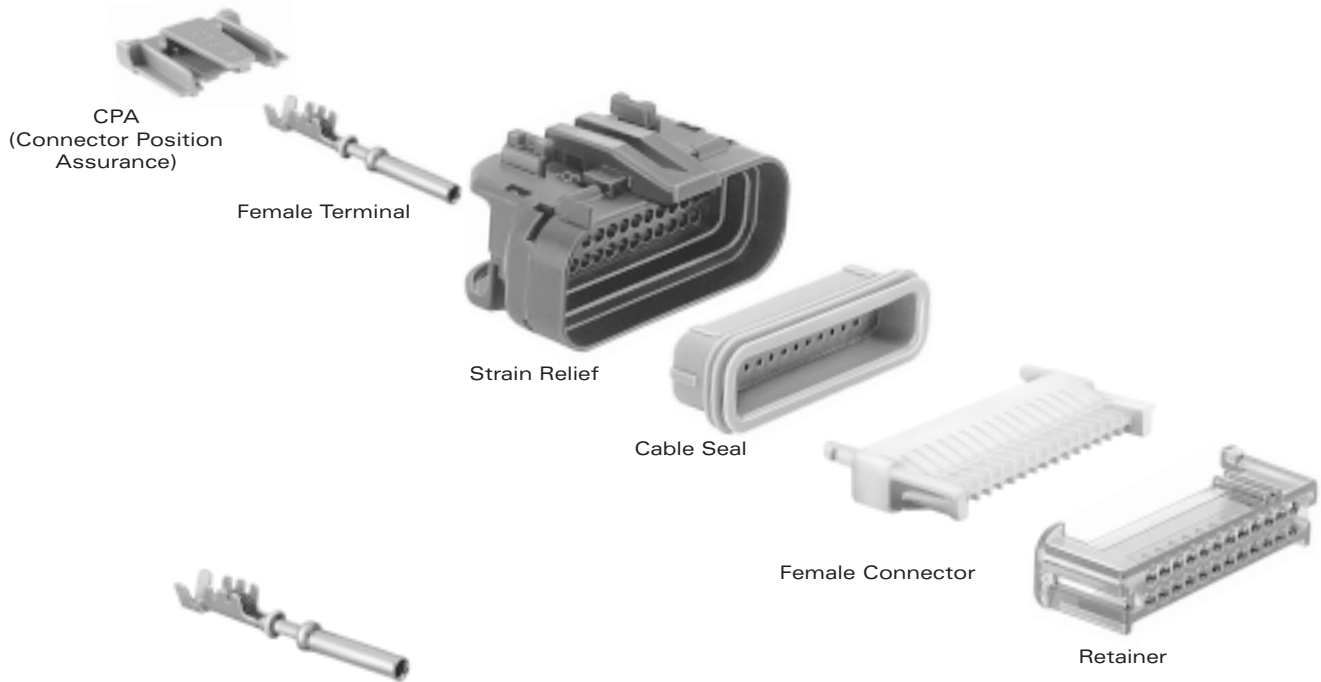

Cross Sectional View

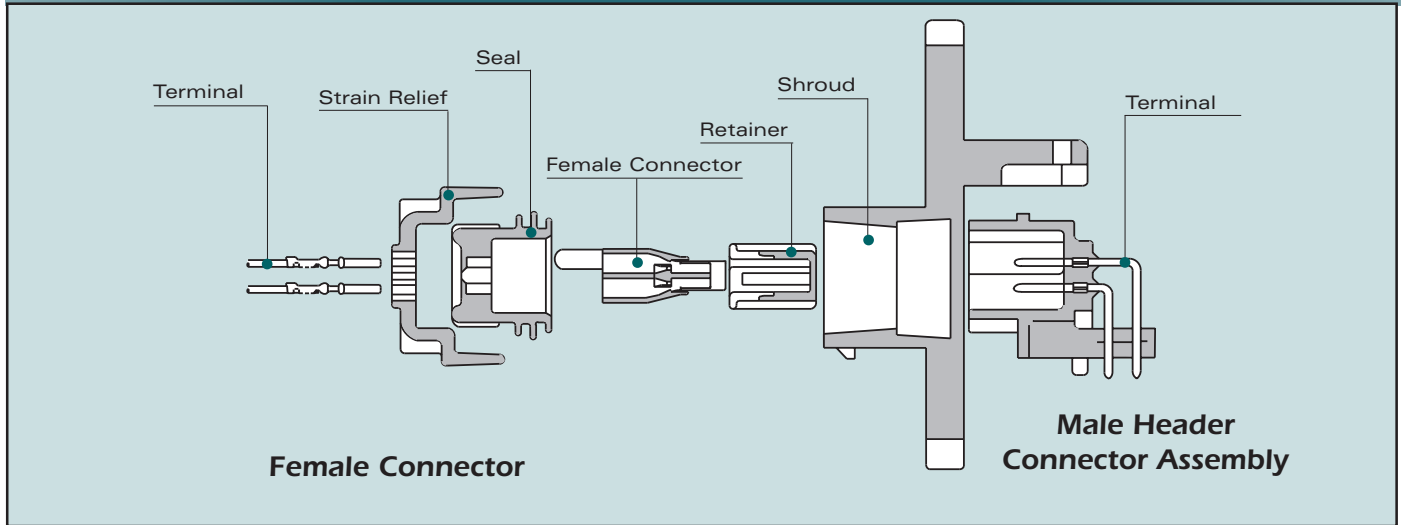

MICRO-PACK FEMALE TERMINALS SEALED

Part #	Cable Range (mm ²)	Material	Plating
12084912	0.80	Phosphor Bronze	Gold/Nickel
12084913	0.50-0.35	Phosphor Bronze	Gold/Nickel

MICRO-PACK FEMALE CONNECTORS SEALED

# Cavities	Connector	Color	Material	TPA	Retainer**	Seal	Strain Relief
24	12129225	Natural	PBT	-	12129183	12110403*	12160848
32	12129025	Natural	PBT	-	12129023	12129026*	12129030
36	12110487	Black	PBT	-	12110488	12110489*	12110490
Mixed							
32	12160423	Black	PBT	12160419	12160418	12160425 12160426	12160424

*Validated for 0.80-0.50 cable.

**Retainers provide terminal position assurance.

<http://delphi.com/products/connect>



Sealed System Application Information

CABLE RANGE (mm²): 0.35-0.8
CURRENT RANGE (AMPS): 0-7.5
TEMP RANGE °C: -40 to 125
RESISTANCE: <10mΩ@20mV
VOLTAGE DROP: <10.0mV/amp
CENTERLINE SPACING (mm): 3.5
TERMINAL DIAMETER (mm): 1.0

MICRO-PACK 100W TERMINALS - Gold Plated

TEMPERATURE RISE ABOVE AMBIENT (25°C) VS CURRENT*

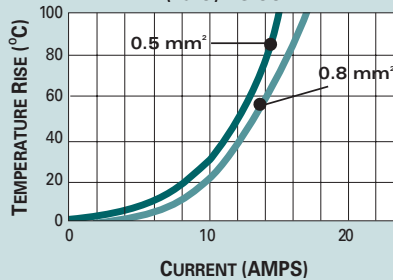

TEMPERATURE DERATING CURVES*

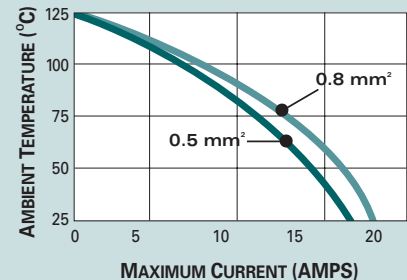

*The test data are based on single circuits in free space and were generated using a "Lumped Resistance" model. This model does not account for all of the variables that would be present in an actual application. For actual product performance, contact your regional support representative at the number listed below.



Male Header Connector Assembly

MICRO-PACK MALE HEADER CONNECTOR ASSEMBLIES SEALED

# Cavities	Connector	Color	Material
24	12092320	Black	PBT 30% GF
32	12129008	Blue	PBT 30% GF
36	12110485	Black	PBT 30% GF
Mixed			
32	12146993	Black	PBT 30% GF

Terminals included in connector assembly.

SECTION NOTES:

- Contact your regional support representative at the number listed below.
- Sealing shroud and locking feature for connector assembly must be designed into mating device housing.

<http://delphi.com/products/connect>

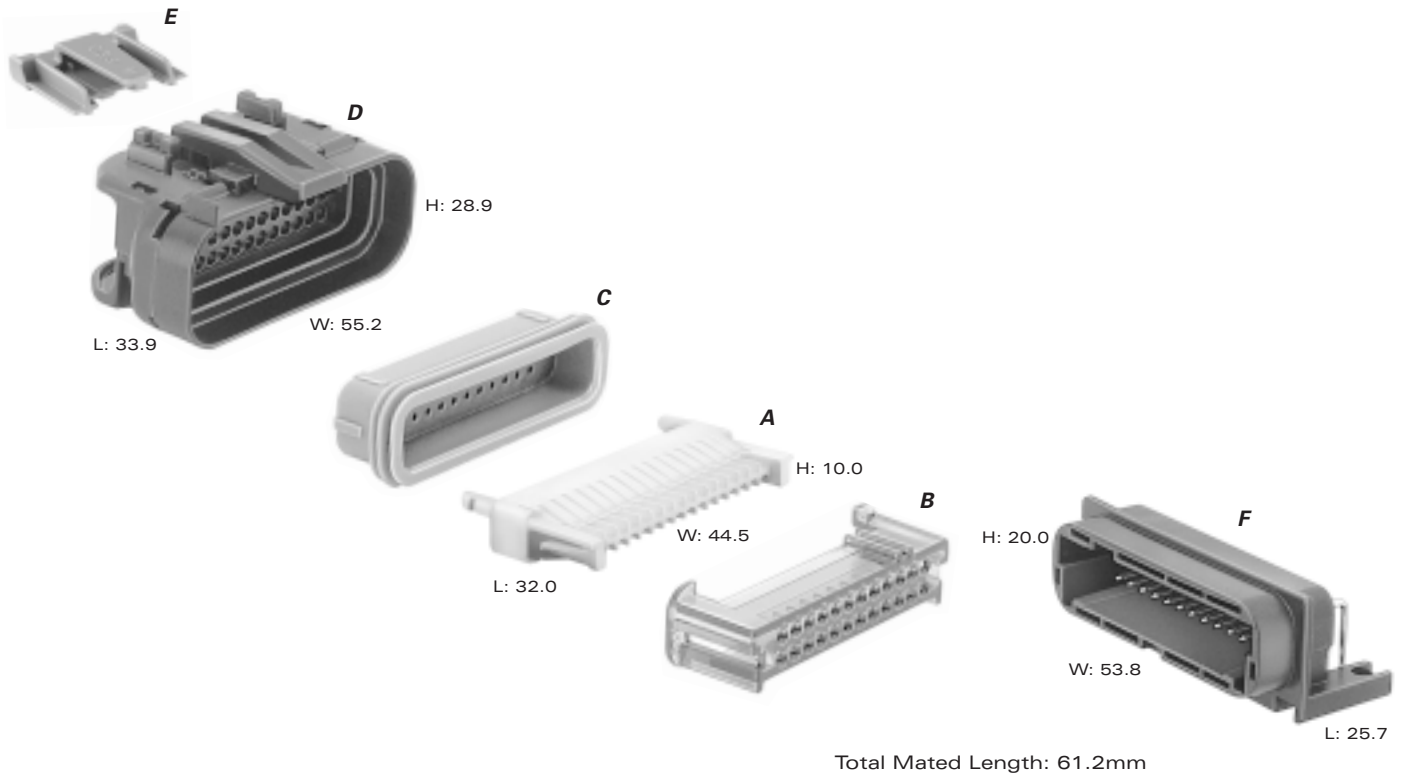

Total Mated Length: 61.2mm

A PART NO: 12129225
 DESCRIPTION: Connector 24F
 SIZE: 32.0L x 10.0H x 44.5
 COLOR: Natural
 MATERIAL: PBT
 TERMINALS: See Page 188

F PART NO: 12092320
 DESCRIPTION: Connector Assembly 24M
 SIZE: 25.7L x 20.0H x 53.8W
 COLOR: Black
 MATERIAL: PBT 30% GF

B PART NO: 12129183
 DESCRIPTION: Retainer 24F
 COLOR: Black
 MATERIAL: PC

C PART NO: 12110403
 DESCRIPTION: Seal 24F
 COLOR: Green
 MATERIAL: Silicone

D PART NO: 12160848 Black (Right Wire Dress)
12129858 Gray (Straight Wire Dress)
12129811 Gray (Right Wire Dress)
 DESCRIPTION: Strain Relief 24F
 SIZE: 33.9L x 28.9H x 55.2W
 MATERIAL: TEEE

E PART NO: 12110299
 DESCRIPTION: CPA
 COLOR: Red
 MATERIAL: PBT

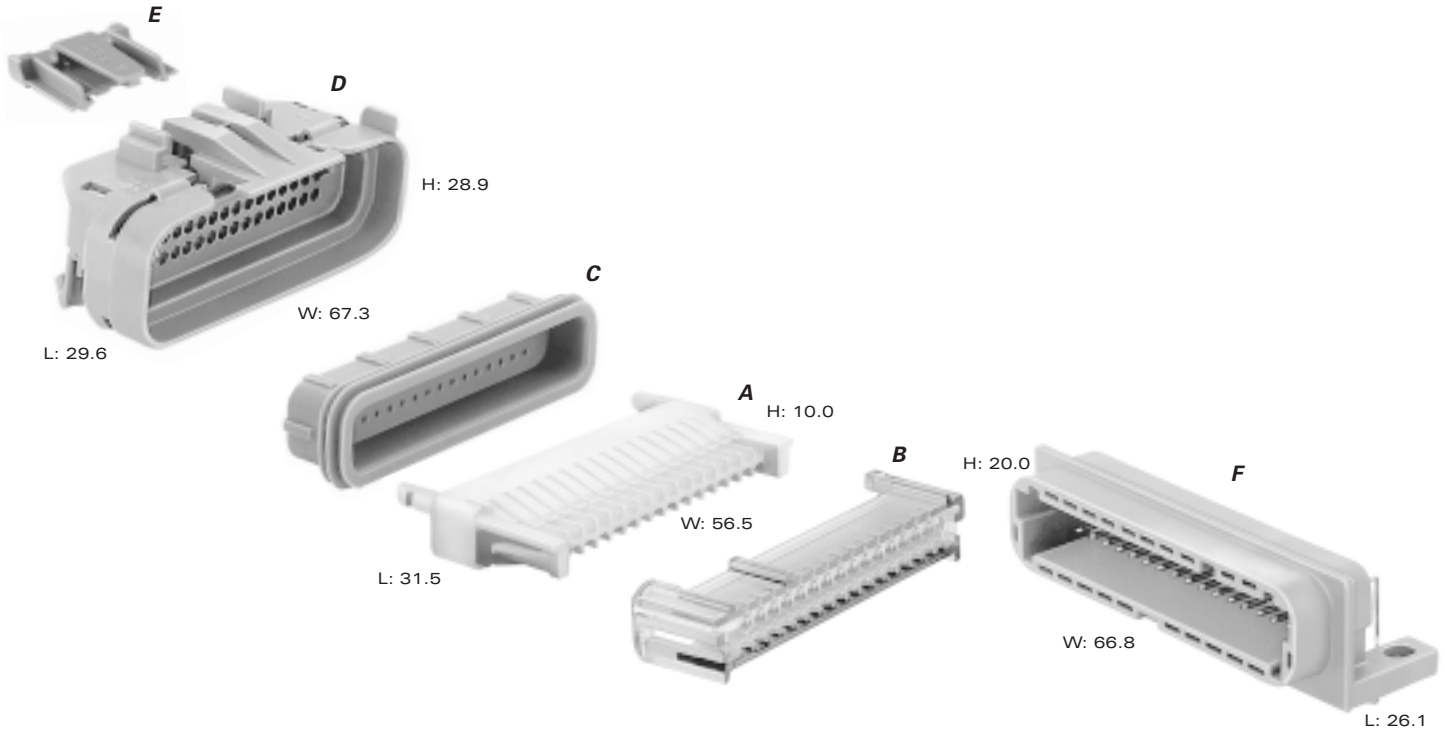

Total Mated Length: 57.6mm

A PART NO: **12129025**
DESCRIPTION: Connector 32F
SIZE: 31.5L x 10.0H x 56.5W
COLOR: Natural
MATERIAL: PBT
TERMINALS: See Page 188

B PART NO: **12129023*** (Md. Blue)
12129021* (Black)
12129022* (Clear)
DESCRIPTION: Retainer 32F
MATERIAL: PC
*DIFFERENT INDEXING FEATURE.

C PART NO: **12129026**
DESCRIPTION: Seal 32F
COLOR: Green
MATERIAL: Silicone

D PART NO: **12129030** (Right Wire Dress)
12129028 (Left Wire Dress)
DESCRIPTION: Strain Relief 32F
SIZE: 29.6L x 28.9H x 67.3W
COLOR: Gray
MATERIAL: TEEE

E PART NO: **12110299**
DESCRIPTION: CPA
COLOR: Red
MATERIAL: PBT

F PART NO: **12129008*** (Blue)
12186041* (Black)
12186043* (Gray)
DESCRIPTION: Connector Assembly 32M
SIZE: 26.1L x 20.0H x 66.8W
MATERIAL: PBT 30% GF
*DIFFERENT INDEXING FEATURE.

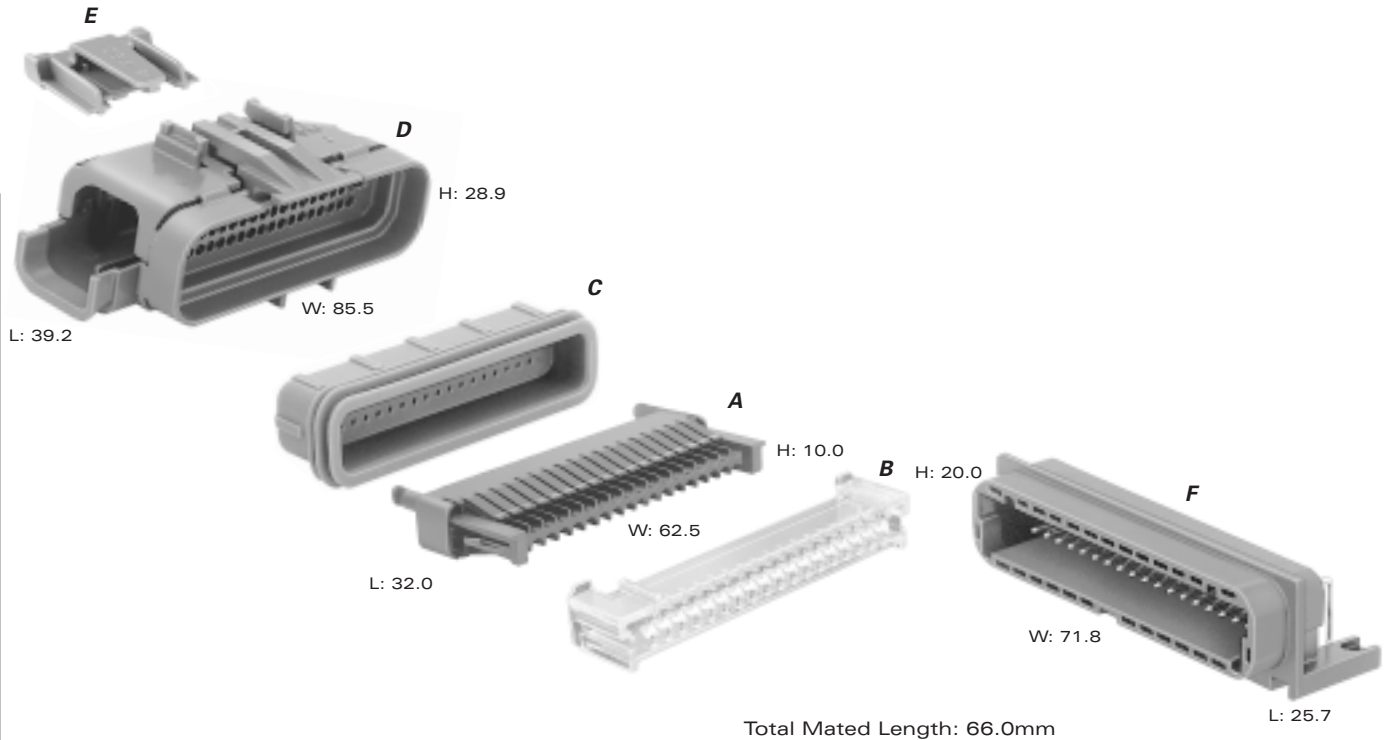

A PART NO: 12110487
 DESCRIPTION: Connector 36F
 SIZE: 32.0L x 10.0H x 62.5W
 COLOR: Black
 MATERIAL: PBT
 TERMINALS: See Page 188

F PART NO: 12110485
 DESCRIPTION: Connector Assembly 36M
 SIZE: 25.7L x 20.0H x 71.8W
 COLOR: Black
 MATERIAL: PBT 30% GF

B PART NO: 12110488
 DESCRIPTION: Retainer 36F
 COLOR: Clear
 MATERIAL: PC

C PART NO: 12110489
 DESCRIPTION: Seal 36F
 COLOR: Green
 MATERIAL: Silicone

D PART NO: 12110490 (Right Wire Dress)
 DESCRIPTION: Strain Relief 36F
 SIZE: 39.2L x 28.9H x 85.5W
 COLOR: Gray
 MATERIAL: TEEE

E PART NO: 12110299
 DESCRIPTION: CPA
 COLOR: Red
 MATERIAL: PBT

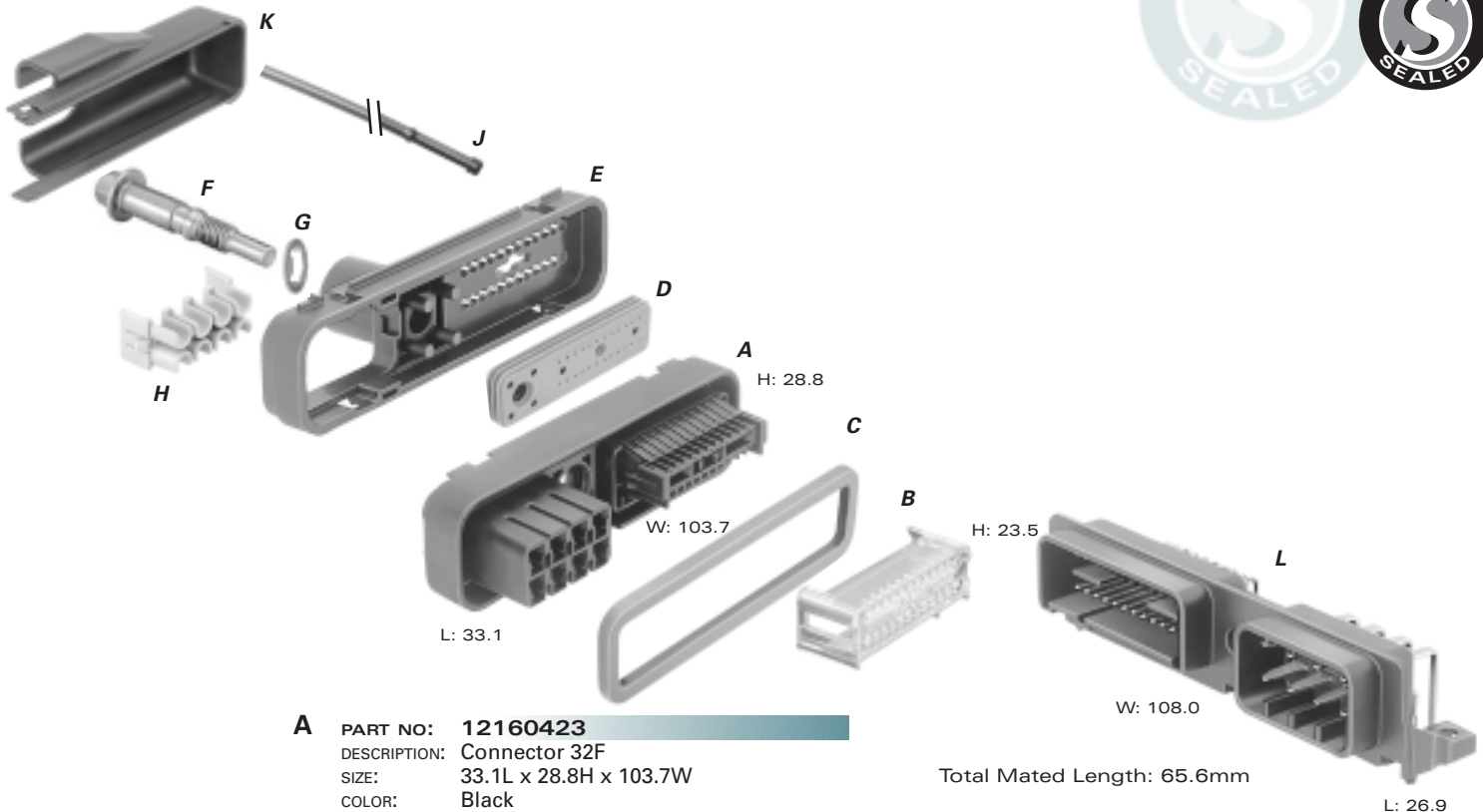

A **PART NO:** 12160423
DESCRIPTION: Connector 32F
SIZE: 33.1L x 28.8H x 103.7W
COLOR: Black
MATERIAL: PBT
TERMINALS: See page 188, Micro-Pack Sealed
 See below, 280 Metri-Pack Tangless

B **PART NO:** 12160418
DESCRIPTION: Retainer 24F
COLOR: Red
MATERIAL: PC

C **PART NO:** 12160425
DESCRIPTION: Connector Seal
COLOR: Green
MATERIAL: Silicone

D **PART NO:** 12160426
DESCRIPTION: Seal 32F
COLOR: Green
MATERIAL: Silicone

E **PART NO:** 12160424
DESCRIPTION: Strain Relief
SIZE: 25.9L x 28.7H x 98.6W
COLOR: Black
MATERIAL: PA66 HS IM 14% GF

F **PART NO:** 12160427
DESCRIPTION: Bolt
SIZE: M4 Hex Head
MATERIAL: Zinc Plated Steel

G **PART NO:** 12103406
DESCRIPTION: Bolt Retainer
MATERIAL: Zinc Plated Steel

H **PART NO:** 12160419
DESCRIPTION: TPA
COLOR: Md. Gray
MATERIAL: PA66 HS IM

Total Mated Length: 65.6mm

J **PART NO:** 12161104
DESCRIPTION: Vent Tube
COLOR: Black
MATERIAL: PA6
LENGTH: 1180mm
APPLICATION: Vents Air Pressure inside Module.

K **PART NO:** 12160420
DESCRIPTION: Wire Dress Cover
COLOR: Black
MATERIAL: PA66 HS IM 14% GF

L **PART NO:** 12146993
DESCRIPTION: Connector Assembly 32M
SIZE: 26.9L x 23.5H x 108.0W
COLOR: Black
MATERIAL: PBT 30% GF

TANGLESS



280 TANGLESS FEMALE TERMINALS SEALED

Part #	Cable Range (mm ²)	Material	Plating
12110853	5.0-3.0	Tin Brass	Tin
12129409	2.0-1.0	Tin Brass	Tin
12110845*	3.0-2.0	Tin Brass	Tin
12110847*	1.0-0.80	Tin Brass	Tin
12110846*	0.50-0.35	Tin Brass	Tin

* **Thin Stock**—Electrical current restrictions may apply, contact your regional support representative at the number listed below.