

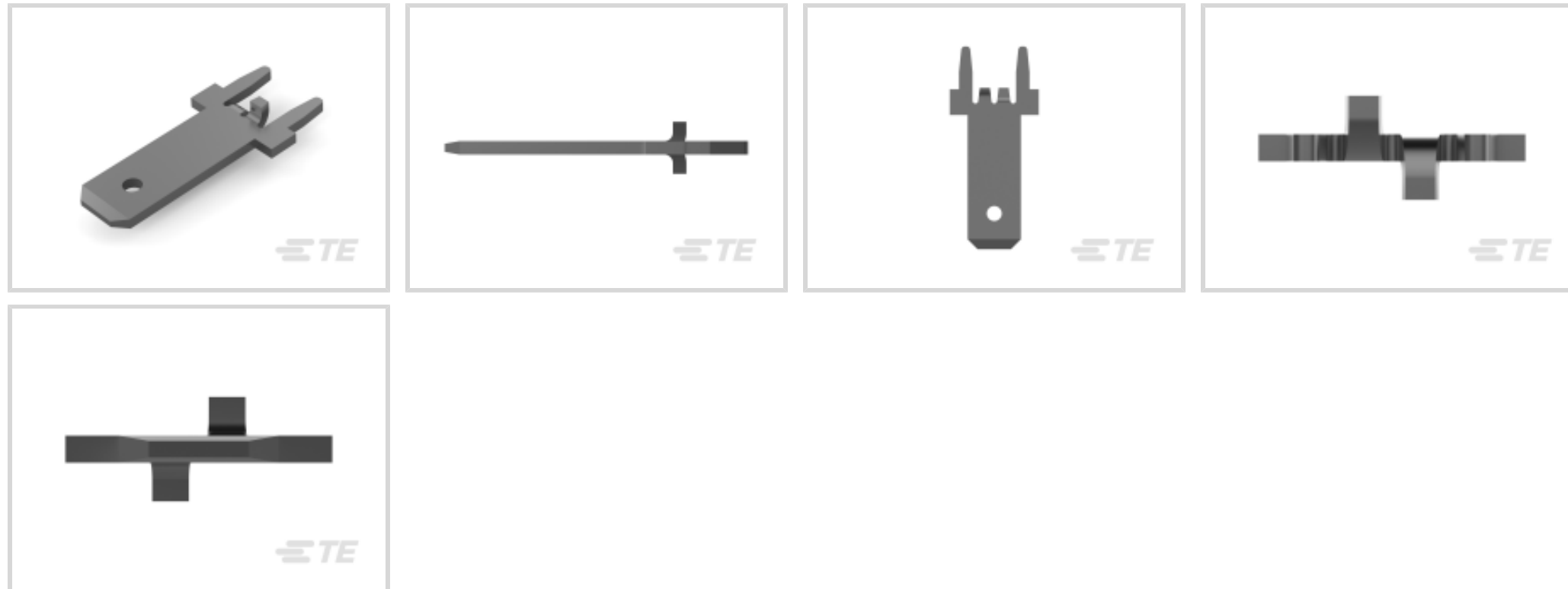

Terminals & Splices > PCB Terminals



PCB Terminal Type: **Tab**

PCB Thickness (Recommended): 1.57 mm [.062 in]

Mating Tab Width: 4.75 mm [.187 in]

Mating Tab Thickness: .81 mm [.032 in]

PCB Hole Diameter: 1.4 mm [.055 in]

### Features

#### Configuration Features

Stud Hole	No
Terminal Angle	180 °

#### Body Features

Plating Thickness	3.81 µm[150 µin]
-------------------	------------------

#### Contact Features

Contact Plating Material	Tin
PCB Terminal Type	Tab
Mating Tab Width	4.75 mm[.187 in]
Mating Tab Thickness	.81 mm[.032 in]
Terminal Plating Material	Tin
Contact Underplating Material	Nickel
Terminal Size	4.75
Terminal Orientation	Vertical

#### Termination Features



Termination Method to Printed Circuit Board	Through Hole - Solder
---------------------------------------------	-----------------------

Product Terminates To	Printed Circuit Board
-----------------------	-----------------------

### Mechanical Attachment

Wire Insulation Support	Without
-------------------------	---------

### Dimensions

Extension Below Board	3.81 mm[.15 in]
-----------------------	-----------------

PCB Thickness (Recommended)	1.57 mm[.062 in]
-----------------------------	------------------

PCB Hole Diameter	1.4 mm[.055 in]
-------------------	-----------------

Profile Height from PCB	14.22 mm[.567 in]
-------------------------	-------------------

### Usage Conditions

Insulation Option	Uninsulated
-------------------	-------------

Operating Temperature Range	-40 – 105 °C[-40 – 221 °F]
-----------------------------	----------------------------

### Packaging Features

Packaging Quantity	10000
--------------------	-------

Packaging Method	Reel
------------------	------

### Other

Comment	Insertion equipment available.
---------	--------------------------------

## Product Compliance

[For compliance documentation, visit the product page on TE.com>](#)

EU RoHS Directive 2011/65/EU	Compliant
------------------------------	-----------

EU ELV Directive 2000/53/EC	Compliant
-----------------------------	-----------

China RoHS 2 Directive MIIT Order No 32, 2016	No Restricted Materials Above Threshold
-----------------------------------------------	-----------------------------------------

EU REACH Regulation (EC) No. 1907/2006	Current ECHA Candidate List: JAN 2022 (223) Candidate List Declared Against: JAN 2022 (223) Does not contain REACH SVHC
----------------------------------------	-------------------------------------------------------------------------------------------------------------------------------











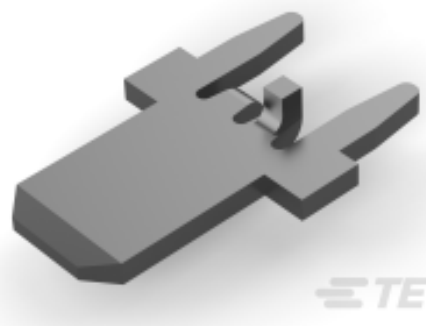

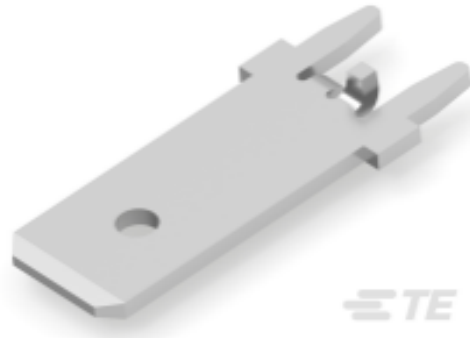
Halogen Content	Low Halogen - Br, Cl, F, I < 900 ppm per homogenous material. Also BFR/CFR/PVC Free
-----------------	-------------------------------------------------------------------------------------

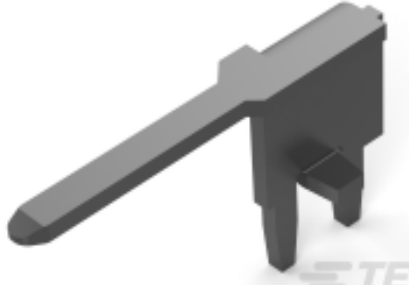
Solder Process Capability	Pin-in-Paste capable to 260°C
---------------------------	-------------------------------

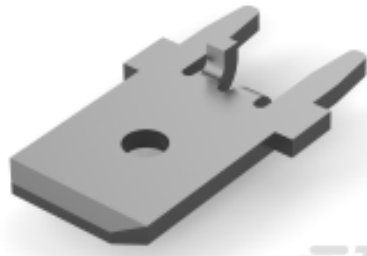
Product Compliance Disclaimer

This information is provided based on reasonable inquiry of our suppliers and represents our current actual knowledge based on the information they provided. This information is subject to change. The part numbers that TE has identified as EU RoHS compliant have a maximum concentration of 0.1% by weight in homogenous materials for lead, hexavalent chromium, mercury, PBB, PBDE, DBP, BBP, DEHP, DIBP, and 0.01% for cadmium, or qualify for an exemption to these limits as defined in the Annexes of Directive 2011/65/EU (RoHS2). Finished electrical and electronic equipment products will be CE marked as required by Directive 2011/65/EU. Components may not be CE marked. Additionally, the part numbers that TE has identified as EU ELV compliant have a maximum concentration of 0.1% by weight in homogenous materials for lead, hexavalent chromium, and mercury, and 0.01% for cadmium, or qualify for an exemption to these limits as defined in the Annexes of Directive 2000/53/EC (ELV). Regarding the REACH Regulation, the information TE provides on SVHC in articles for this part number is based on the latest European Chemicals Agency (ECHA) 'Guidance on requirements for substances in articles' posted at this URL: <https://echa.europa.eu/guidance-documents/guidance-on-reach>

## Compatible Parts

 <p>TE Part # 63860-1 187 FASTON TAB TPBR</p>	 <p>TE Part # 63525-1 187 FASTON TAB TPBR</p>	 <p>TE Part # 1217133-1 187 FASTON,PCB TAB,TNBR</p>	 <p>TE Part # 1217127-1 250 FASTON,PCB TAB,TPBR</p>
 <p>TE Part # 1217125-1 250 FASTON,PCB TAB,TPBR</p>	 <p>TE Part # 1742361-1 187 FASTON,PCB TAB,TPBR</p>	 <p>TE Part # 1217088-1 FASTON SPECIAL PCB TAB TPBR</p>	 <p>TE Part # 1217332-1 187 FASTON,PCB TAB,TCBR</p>
 <p>TE Part # 1217861-2 250 FASTON,PCB TAB,TCBR</p>	 <p>TE Part # 63824-1 250 FASTON TAB TPBR</p>	 <p>TE Part # 1217089-1 110 FASTON,PCB TAB,TNBR</p>	 <p>TE Part # 1217126-1 250 FASTON,PCB TAB,TPBR</p>
 <p>TE Part # 1217539-1 250 FASTON,PCB TAB,TCBR</p>	 <p>TE Part # 1217124-3 187 FASTON,PCB TAB,TNBR</p>	 <p>TE Part # 1217126-4 250 FASTON,PCB TAB,TPBR</p>	 <p>TE Part # 1742646-2 187 FASTON,TAB,PCB,TPBR</p>



### Also in the Series | FASTON 187

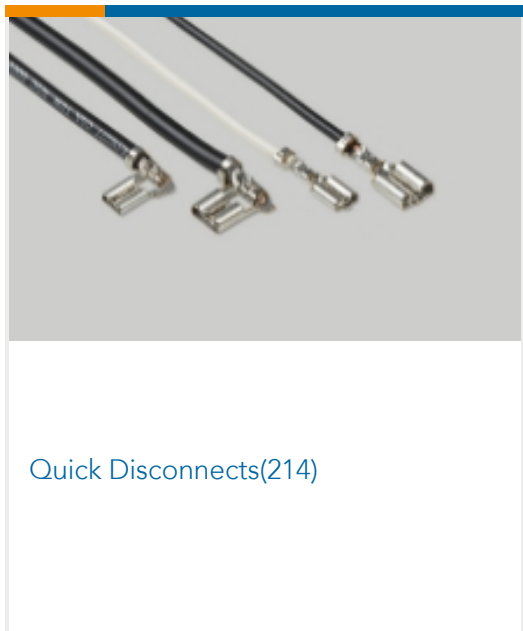
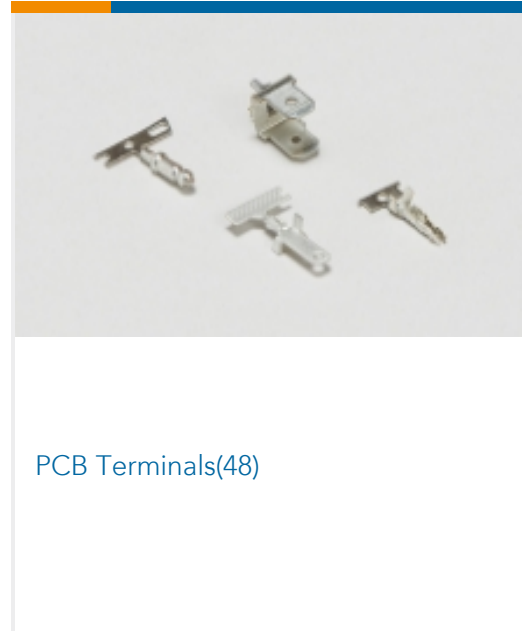
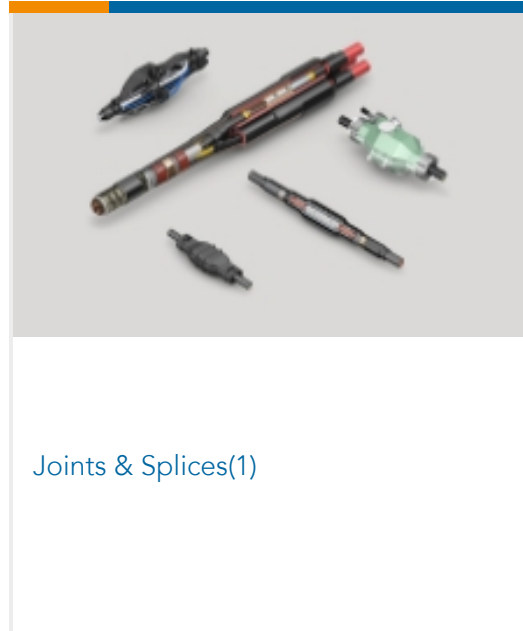
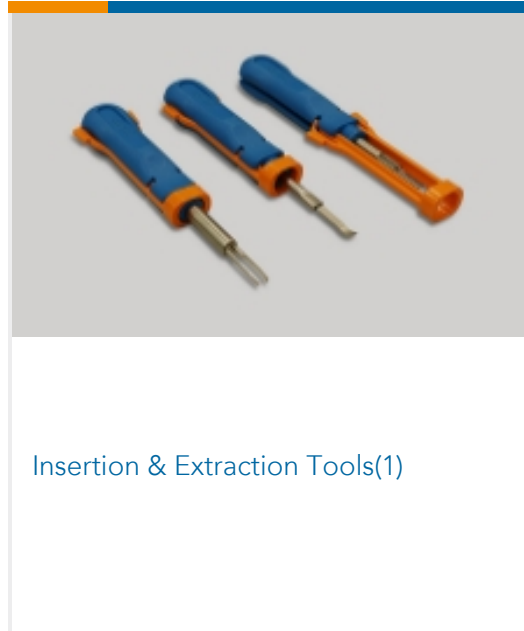
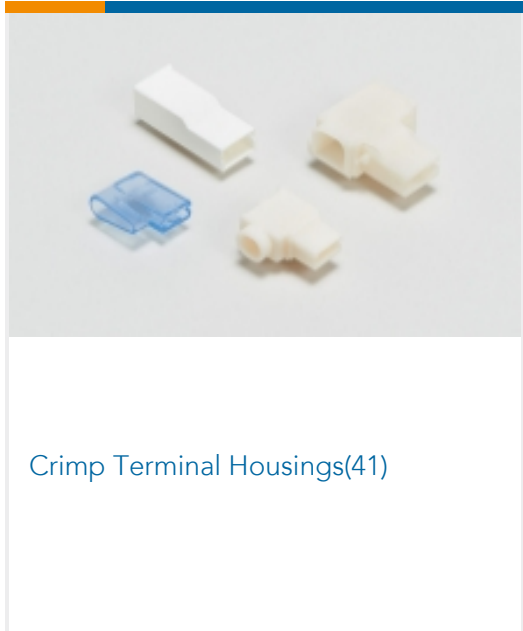

### Customers Also Bought

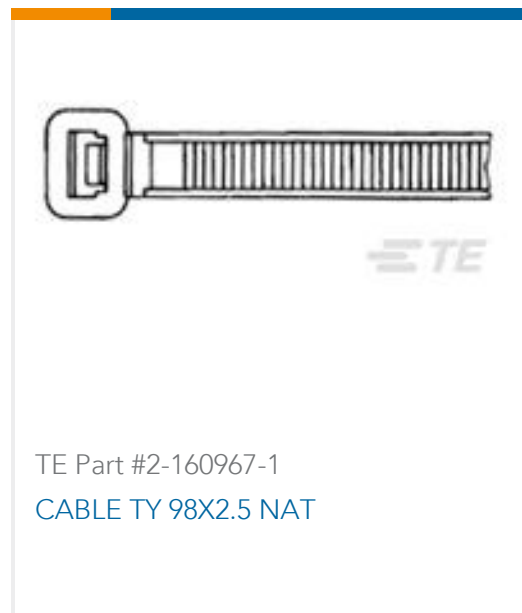
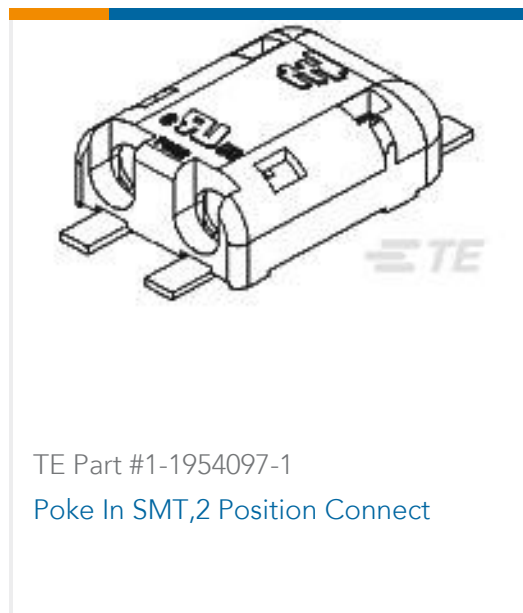
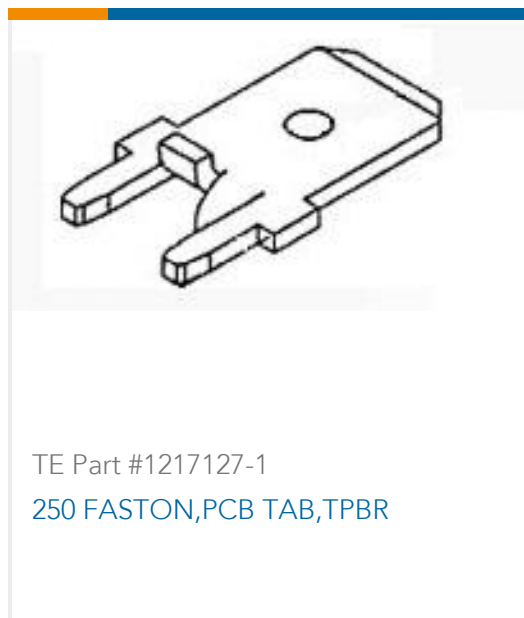



## Documents

### Product Drawings

[187 FASTON,PCB TAB,TNBR](#)

English

### CAD Files

[3D PDF](#)

3D

Customer View Model

[ENG\\_CVM\\_CVM\\_1217124-1\\_F\\_c-1217124-1-f.2d\\_dxf.zip](#)

English

Customer View Model

[ENG\\_CVM\\_CVM\\_1217124-1\\_F\\_c-1217124-1-f.3d\\_igs.zip](#)

English

Customer View Model

[ENG\\_CVM\\_CVM\\_1217124-1\\_F\\_c-1217124-1-f.3d\\_stp.zip](#)

English

By downloading the CAD file I accept and agree to the [Terms and Conditions](#) of use.

### Datasheets & Catalog Pages

[FASTON PCB Tabs and Receptacles](#)

English

[PRINTED CIRCUIT BOARD TERMINALS AND DISCONNECTS](#)

English

### Product Specifications

[Application Specification](#)

English

### Product Environmental Compliance

[TE Material Declaration](#)

English