

DIMENSIONS FOR LEFT SIDE HOUSING
 COLOUR BLACK - POS. 27-52 - ITEM 4
 (DIMENSIONI BLOCCETTO LATO SINISTRO
 COLORE NERO - VIE 27-52 - COMPONENTE N°4

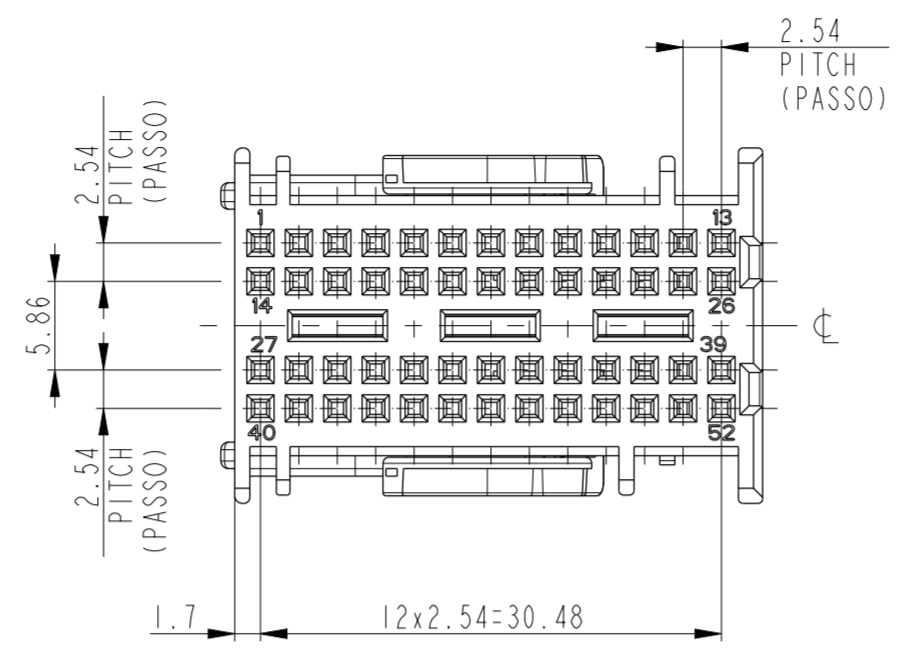
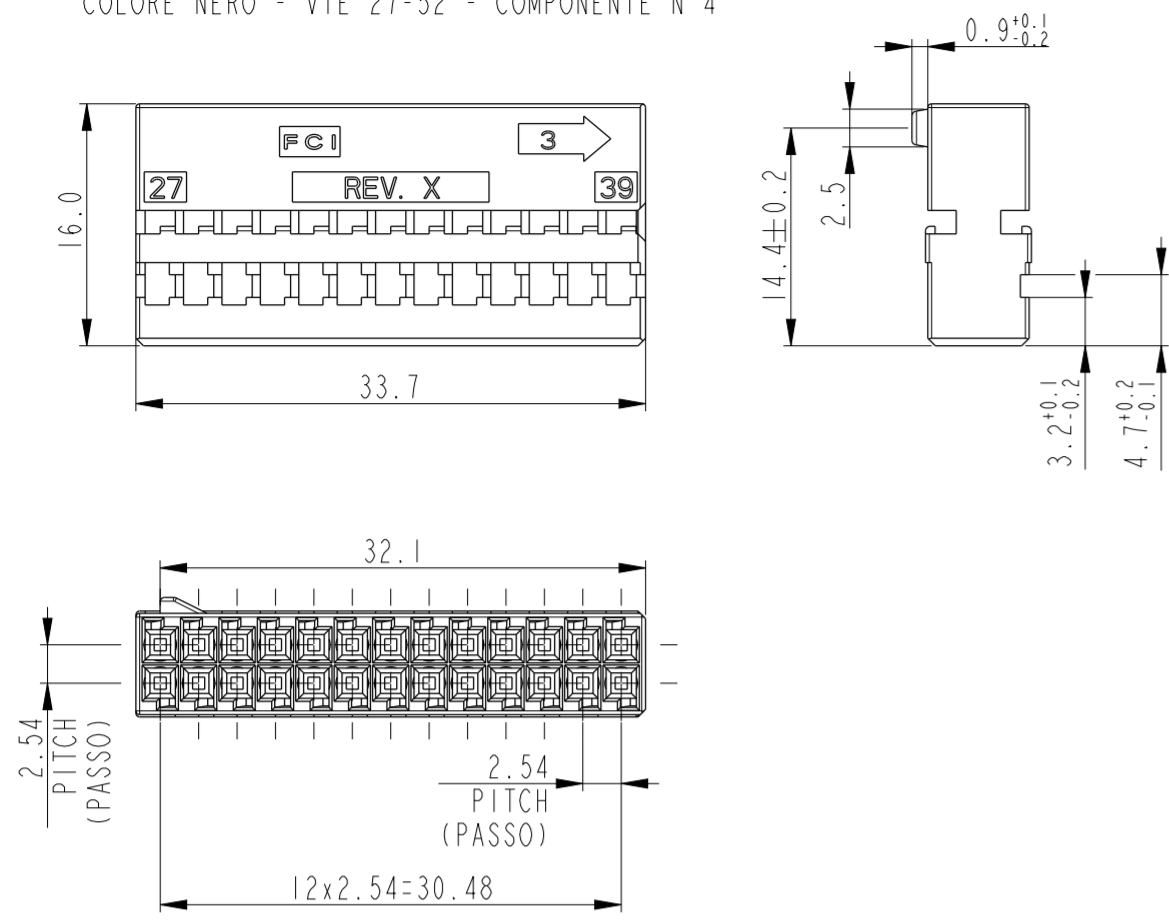

P/N PP10000636 AS SHOWN
 (COME MOSTRATO)

PART LIST
(LISTA COMPONENTI)

ITEM (N°)	DESCRIPTION (DESCRIZIONE)	MATERIAL (MATERIALE)	QUANTITY REQUIRED PER ASSEMBLY (QUANTITÀ RICHIESTA PER ASSEMBLATO)	
1	LEVER (LEVA)	PA66 GF 30% COLOUR RED (COLORE ROSSO)	1	1
2	COVER (CORAZZA)	PA66 GF 15% COLOUR BLACK (COLORE NERO)	1	1
3	COVER (CORAZZA)	PA66 GF 15% COLOUR BLUE (COLORE BLU)	1	1
4	26W FEMALE HOLDER (BLOCCETTO PORTA FEMMINE 26VIE)	PA66 GF 15% COLOUR BLACK (COLORE NERO)	1	1
5	26W FEMALE HOLDER (BLOCCETTO PORTA FEMMINE 26VIE)	PA66 GF 15% COLOUR GREY (COLORE GRIGIO)	1	1

MVL	PART NO.	PP10000637	PP10000636
	PART REV.	A	A
DELPHI	PART NO.	13707581	13707967
	PART REV.	01	01
	COLOUR/COLORE	BLACK/NERO	BLUE/BLU

DIMENSIONS FOR RIGHT SIDE HOUSING
 COLOUR GREY - POS. 1-26 - ITEM 5
 (DIMENSIONI BLOCCETTO LATO DESTRO
 COLORE GRIGIO - VIE 1-26 - COMPONENTE N°5

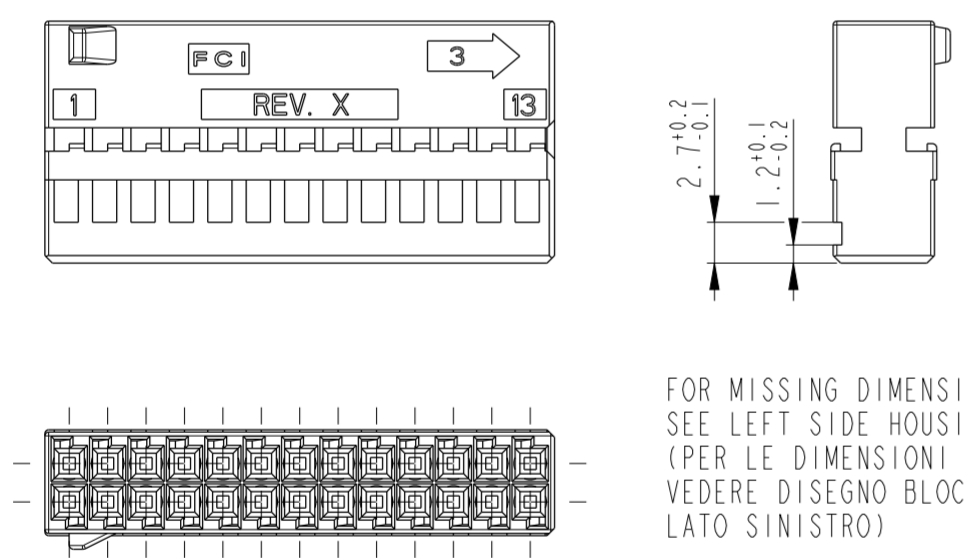

FOR MISSING DIMENSIONS
 SEE LEFT SIDE HOUSING DRAWING
 (PER LE DIMENSIONI MANCANTI
 VEDERE DISEGNO BLOCCETTO
 LATO SINISTRO)

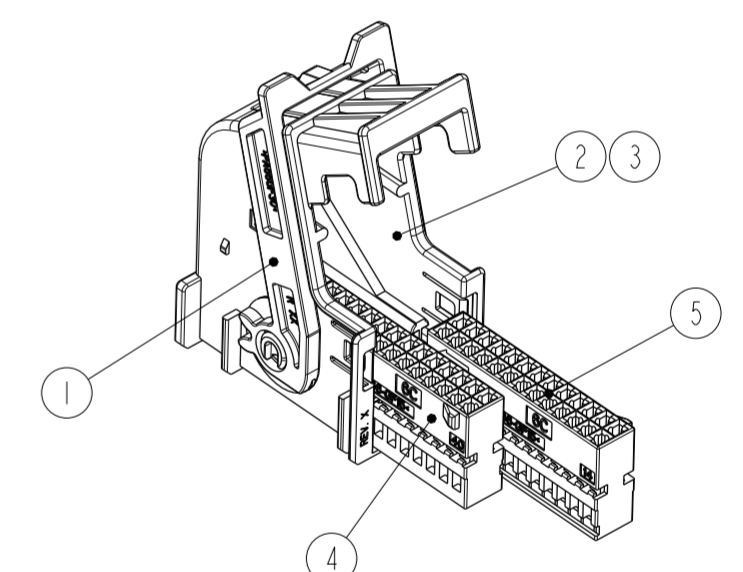
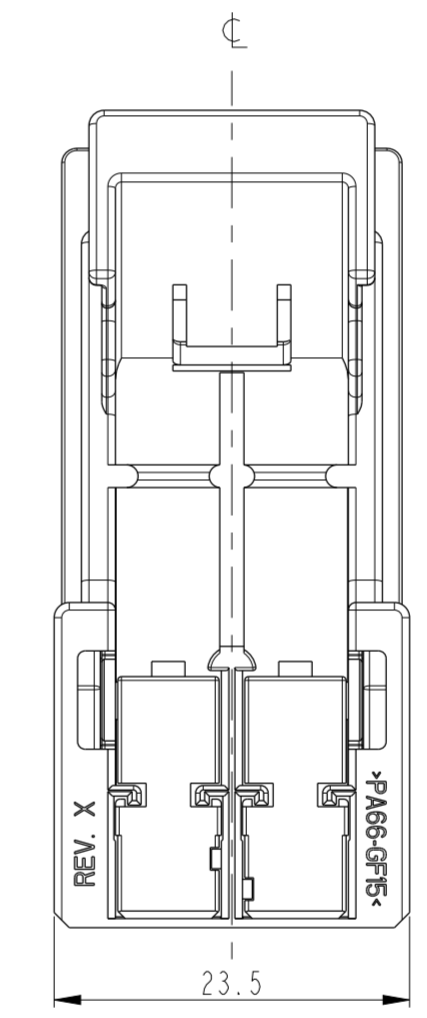
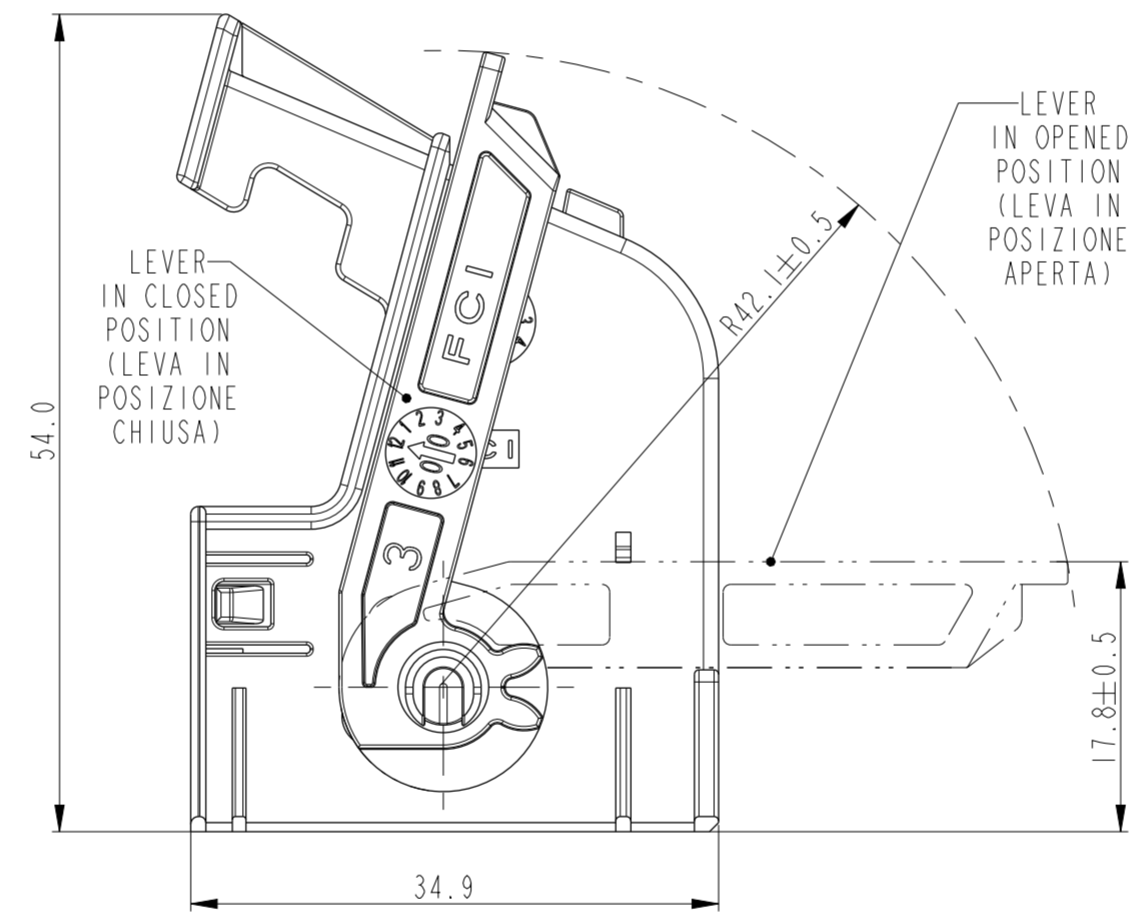

SCALE 1:1

1 THE PRODUCT IS SUPPLIED IN KIT WITH THE LEVER ASSEMBLED IN CLOSED POSITION AND THE 2 HOUSINGS IN SEPARATE PLASTIC BAGS (IL PRODOTTO VIENE FORNITO IN KIT CON LA LEVA MONTATA IN POSIZIONE CHIUSA E I 2 BLOCCETTI IN SACCHETTI A PARTE)

2 NUMBER 26+26 CAVITIES SUITABLE FOR 0.64 DUO TWIN FEMALE CONTACTS
 NUMERO 26+26 CAVITÀ PER CONTATTI FEMMINA 0.64 DUO TWIN

MVL		DELPHI	
PART NO.	PART REV.	PART NO.	PART REV.
60080111	E	10820519	01
60080131	E	10820518	01

MECHANICAL CODING DIMENSIONS
 P/N PP10000637 - COLOUR BLACK
 (DIMENSIONI POLARIZZAZIONE MECCANICA
 P/N PP10000637 - COLORE NERO)

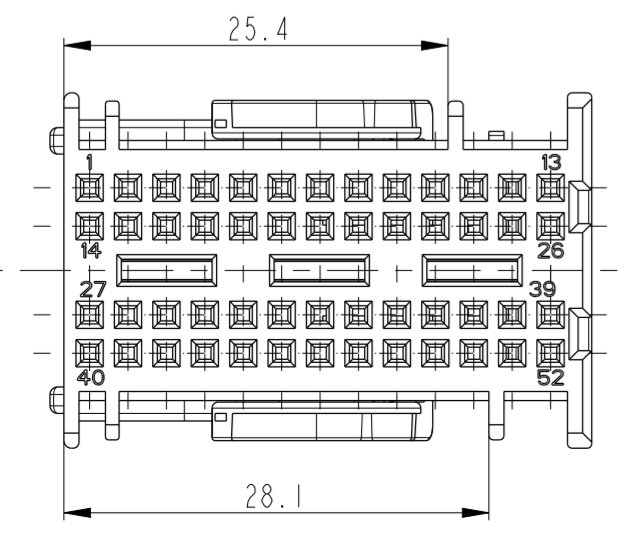

MECHANICAL CODING DIMENSIONS
 P/N PP10000636 - COLOUR BLUE
 (DIMENSIONI POLARIZZAZIONE MECCANICA
 P/N PP10000636 - COLORE BLU)

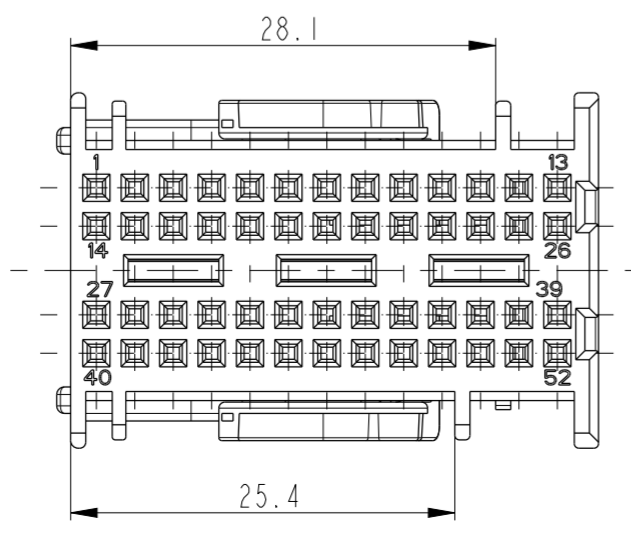

ECN-NO. NUMERO_ECH	POSITION POSIZIONE	CHANGE DESCRIPTION DESCRIZIONE MODIFICA	
PRODUCT SPEC. SPEC. DI PRODOTTO	PACKAGING SPEC. SPEC. DI IMBALLAGGIO	APPLICATION SPEC. SPEC. DI APPLICAZIONE	COPYRIGHT DELPHI CORPORATION AND/OR ITS AFFILIATES. ALL RIGHTS RESERVED. REVISED
IPS 305	PP10000636-7	IPS 306	DELPHI P/N ADDED
G2 General optimization and changed housing material from PBT to PA66			
TOLERANCES TOLLERANZE	±0.3mm / ±1*	MATERIAL : MATERIALE :	SEE TABLE
COUNTERPART Nr. CONTROPARTE Nr.	DATE DATA	NAME NOME	DESCRIPTION DESCRIZIONE
DO NOT MEASURE DRAWING DISEGNO FUORI SCALA	2005/12/19	F PATALACCI	DUO TWIN FEMALE CONNECTOR
CREATED BY CREATO DA	2013/03/26	Fabrizio GIRARDI	PROJECT PROGETTO
MODIFIED BY MODIFICATO DA	2013/04/18	G BARRAL	52W FOR BODY COMPUTER
CHECKED BY CONTROLLATO DA	2013/04/18	M COLOMBO	ESR NO. NUMERO ESR
APPROVED BY APPROVATO	2013/04/18	M COLOMBO	EU-050602
FILE NAME NOME FILE	PCC0112853	CAT. NO. NUMERO CAT.	SEE TABLE
		DOCUMENT UNDER PDS CONTROL DOCUMENTO GESTITO IN P.D.S.	NO MODIFICATION ALLOWED OUTSIDE. NESSUNA MODIFICA CONSENTITA FUORI SISTEMA

DELPHI	DELPHI PACKARD ELECTRICAL/ELECTRONIC ARCHITECTURE TORINO, ITALY	CAD SYSTEM
		pro / eng.
		DWG SIZE FORMATO
		A2
		DIMENSION IN MILLIMETERS DIMENSIONI IN MILLIMETRI
		APPROVAL LEVEL LIVELLO DI APPROVAZIONE
		C
		SHEET FOGLIO
		1 of 1 di 1
		SCALE SCALA
		2:1