

1-962845-1 ✓ ACTIVE

Timer Connector System

TE Internal #: 1-962845-1

TE Internal Description: TAB 5.8x0.8 CONTACT CS SRC Sn
TIMER, RECEPTACLE AND TAB

[View on TE.com >](#)



All TIMER, RECEPTACLE AND TAB (346)

Product Compliance

[For compliance documentation, visit the product page on TE.com>](#)

EU RoHS Directive 2011/65/EU	Compliant
EU ELV Directive 2000/53/EC	Compliant
China RoHS 2 Directive MIIT Order No 32, 2016	No Restricted Materials Above Threshold
EU REACH Regulation (EC) No. 1907/2006	Current ECHA Candidate List: JAN 2022 (223) Candidate List Declared Against: JAN 2022 (223) Does not contain REACH SVHC
Halogen Content	Low Halogen - Br, Cl, F, I < 900 ppm per homogenous material. Also BFR/CFR/PVC Free
Solder Process Capability	Not applicable for solder process capability

Product Compliance Disclaimer

This information is provided based on reasonable inquiry of our suppliers and represents our current actual knowledge based on the information they provided. This information is subject to change. The part numbers that TE has identified as EU RoHS compliant have a maximum concentration of 0.1% by weight in homogenous materials for lead, hexavalent chromium, mercury, PBB, PBDE, DBP, BBP, DEHP, DIBP, and 0.01% for cadmium, or qualify for an exemption to these limits as defined in the Annexes of Directive 2011/65/EU (RoHS2). Finished electrical and electronic equipment products will be CE marked as required by Directive 2011/65/EU. Components may not be CE marked. Additionally, the part numbers that TE has identified as EU ELV compliant have a maximum concentration of 0.1% by weight in homogenous materials for lead, hexavalent chromium, and mercury, and 0.01% for cadmium, or qualify for an exemption to these limits as defined in the Annexes of Directive 2000/53/EC (ELV). Regarding the REACH Regulation, the information TE provides on SVHC in articles for this part number is based on the latest European Chemicals Agency (ECHA) 'Guidance on requirements for substances in articles' posted at this URL: <https://echa.europa.eu/guidance-documents/guidance-on-reach>

Compatible Parts



TE Part # 4-1579007-3
EXTRACTION TOOL KIT



TE Part # 1-1579007-6
EXTRACTION TOOL



TE Part # 2305570-1
TERMINAL CUTTER, SIDE FEED



TE Part # 927833-2
SPT REC 6.3 Contact SRC Sn



TE Part # 1241404-1
AMP MCP 6.3/4.8K, CONTACT



TE Part # 2836095-2
OCEAN-2.0-APPLICATOR-S-110F169O



TE Part # 7-2836095-2
OCEAN-2.0-APPLICATOR-S-110F169O



TE Part # 7-2836095-7
OCEAN_2.0_SPARE_PART_KIT-110F169O



TE Part # 2-2836095-2
OCEAN-2.0-APPLICATOR-S-110F169O

Also in the Series | Timer Connector System



Automotive Connector Caps & Covers (11)



Automotive Connector Locks & Position Assurance(16)



Automotive Housings(219)



Automotive Seals & Cavity Plugs(31)

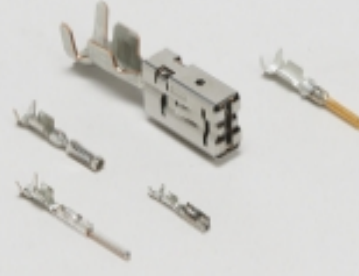

Automotive Terminals(140)



Crimp Terminal Housings(13)



Insertion & Extraction Tools(20)



Other Automotive Connector Accessories(1)

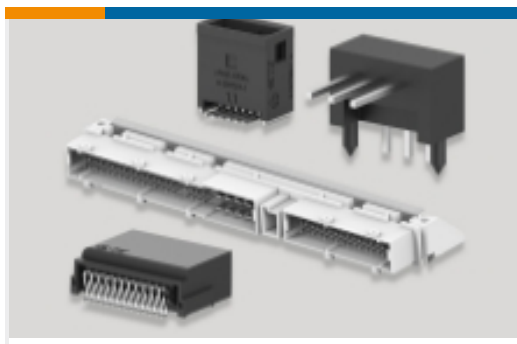

PCB Headers & Receptacles(78)



Quick Disconnects(4)

Customers Also Bought

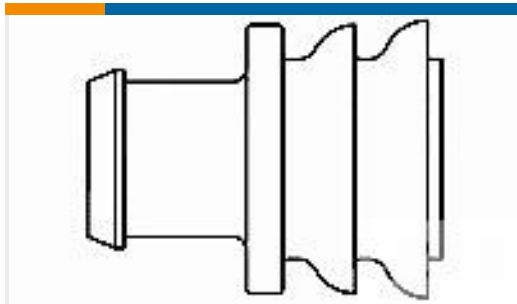
TE Part #281934-2
SINGLE WIRE SEALTE Part #DT04-2P
DEUTSCH DT Series Housings & ConnectorsTE Part #W2S
DEUTSCH DT WEDGELOCKSTE Part #0460-202-16141
DEUTSCH SOLID CONTACTSTE Part #282104-1
AMP SUPERSEAL 1.5MM,
CONNECTOR HOUSINGTE Part #114017-ZZ
SEALING PLUG, SIZE 12/16, WHT

Documents

Product Drawings

[TAB 5.8x0.8 CONTACT CS SRC Sn](#)

English

[TAB 5.8x0.8 CONTACT CS SRC Sn](#)

English

CAD Files

Customer View Model

[ENG_CVM_1-962845-1_A1.3d_igs.zip](#)

English

Customer View Model

[ENG_CVM_1-962845-1_A1.3d_stp.zip](#)

English

Customer View Model

[ENG_CVM_1-962845-1_A1.2d_dxf.zip](#)

English

[3D PDF](#)



English

By downloading the CAD file I accept and agree to the [Terms and Conditions](#) of use.

Datasheets & Catalog Pages

Timer Interconnection System

English

Product Specifications

Application Specification

German

Application Specification

English

Application Specification

English