

1028-005-0305 ✓ ACTIVE

DEUTSCH | DEUTSCH DT, DEUTSCH DTM

TE Internal #: 1028-005-0305

Automotive Connector Caps & Covers, Backshell, Cable Exit Angle 180° (In-Line), Black, PA GF, Wire-to-Wire, 3 Position, DEUTSCH DTM

[View on TE.com >](#)



Connectors > Automotive Connectors > Connector Accessories > Connector Caps & Covers > DEUTSCH DTM BACKSHELLS



Protection & Strain Relief Accessory Type: **Backshell**

Cable Exit Angle: **180° (In-Line)**

Strain Relief: **With**

Primary Product Color: **Black**

Primary Product Material: **PA GF**

[All DEUTSCH DTM BACKSHELLS \(10\)](#)

Features

Product Type Features

Protection & Strain Relief Accessory Type	Backshell
Connector System	Wire-to-Wire
Sealable	No
Connector & Contact Terminates To	Wire & Cable

Configuration Features

Number of Positions	3
---------------------	---

Body Features

Cable Exit Angle	180° (In-Line)
Primary Product Color	Black
Primary Product Material	PA GF

Mechanical Attachment

Strain Relief	With
---------------	------



Dimensions

Compatible Cable Bundle Diameter Range	0 – 8.5 mm[0 – .225 in]
--	-------------------------

Usage Conditions

Compatible With Connector Style	Plug
Operating Temperature (Max)	125 °C[257 °F]
Operating Temperature Range	-55 – 125 °C[-67 – 257 °F]

Industry Standards

Degree of Protection	IP6K9K
UL Flammability Rating	UL 94HB

Packaging Features

Packaging Method	Box
------------------	-----

Other

Serviceable	Yes
-------------	-----

Product Compliance

[For compliance documentation, visit the product page on TE.com>](#)

EU RoHS Directive 2011/65/EU	Compliant
EU ELV Directive 2000/53/EC	Compliant
China RoHS 2 Directive MIIT Order No 32, 2016	No Restricted Materials Above Threshold
EU REACH Regulation (EC) No. 1907/2006	Current ECHA Candidate List: JAN 2022 (223) Candidate List Declared Against: JAN 2022 (223) Does not contain REACH SVHC
Halogen Content	Low Halogen - Br, Cl, F, I < 900 ppm per homogenous material. Also BFR/CFR/PVC Free
Solder Process Capability	Not reviewed for solder process capability

Product Compliance Disclaimer

This information is provided based on reasonable inquiry of our suppliers and represents our current actual knowledge based on the information they provided. This information is subject to change. The part numbers that TE has identified as EU RoHS compliant have a maximum concentration of 0.1% by weight in homogenous materials for lead, hexavalent chromium, mercury, PBB, PBDE, DBP, BBP, DEHP, DIBP, and 0.01% for cadmium, or qualify for an exemption to these limits as defined in the Annexes of Directive 2011/65/EU (RoHS2). Finished electrical and electronic equipment products will be CE marked as required by Directive 2011/65/EU. Components may not be CE marked. Additionally, the part numbers that TE has identified as EU ELV compliant have a maximum concentration of 0.1% by weight in homogenous materials for lead, hexavalent chromium, and mercury, and 0.01% for cadmium, or qualify for an exemption to these limits as defined in the Annexes of Directive 2000/53/EC (ELV). Regarding the REACH Regulation, the information TE provides on SVHC in articles for this part number is based on the latest European Chemicals Agency (ECHA) 'Guidance on

requirements for substances in articles' posted at this URL: <https://echa.europa.eu/guidance-documents/guidance-on-reach>

Compatible Parts



Also in the Series | DEUTSCH DT

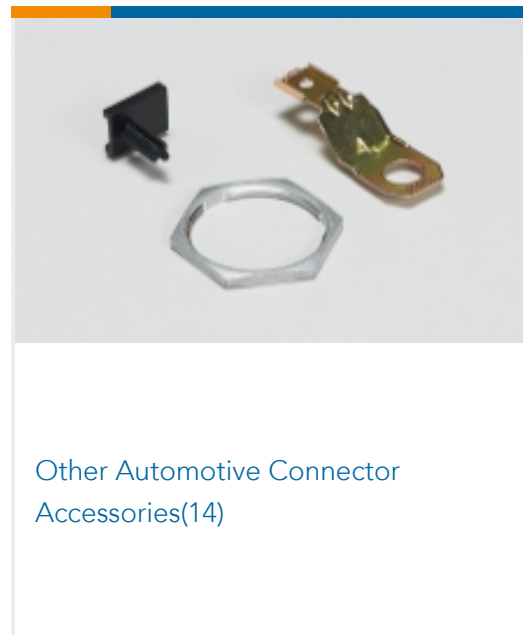
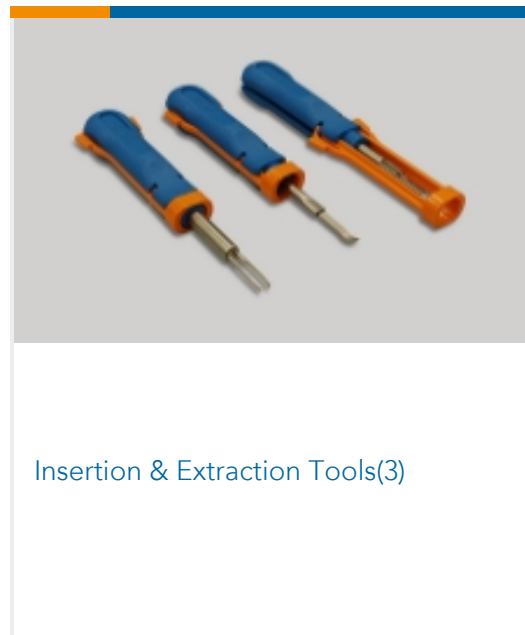
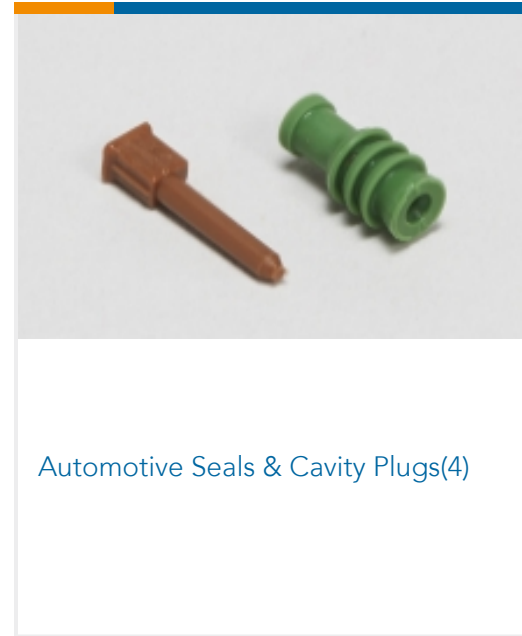
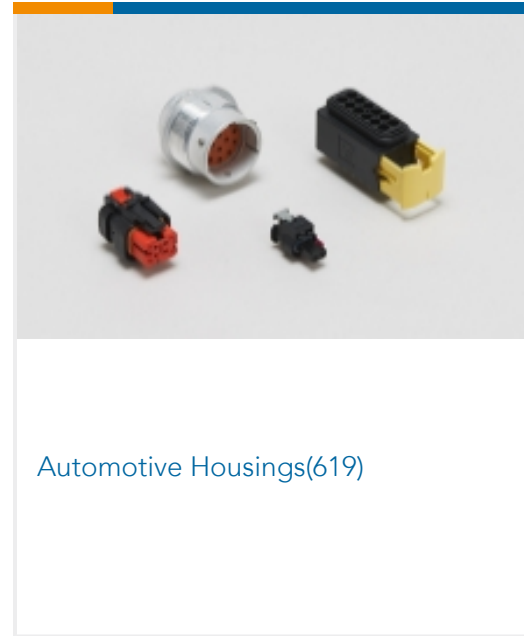
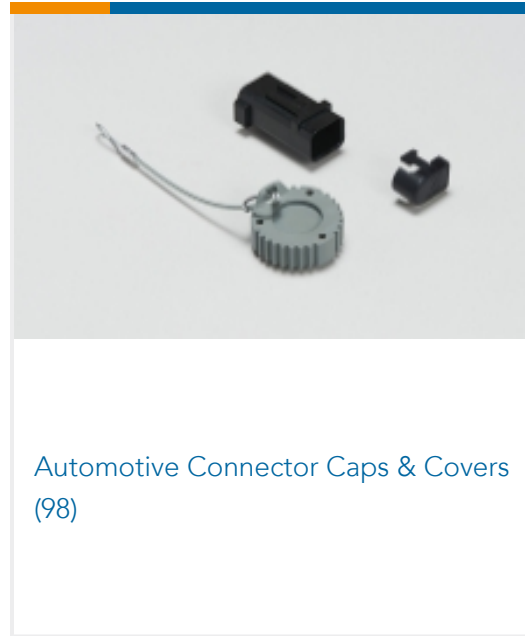

Also in the Series | DEUTSCH DTM

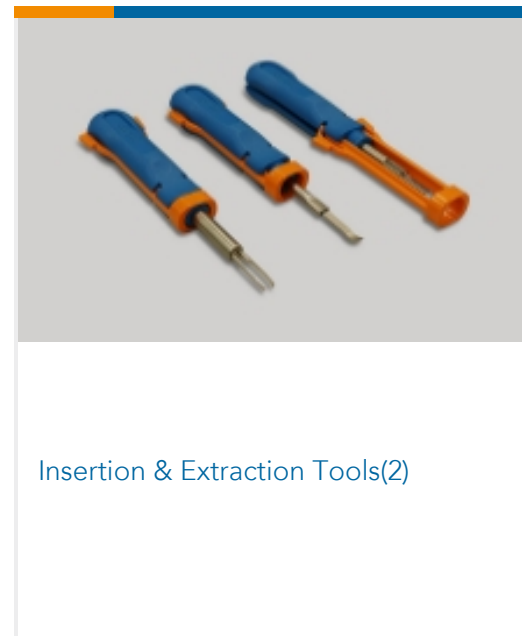
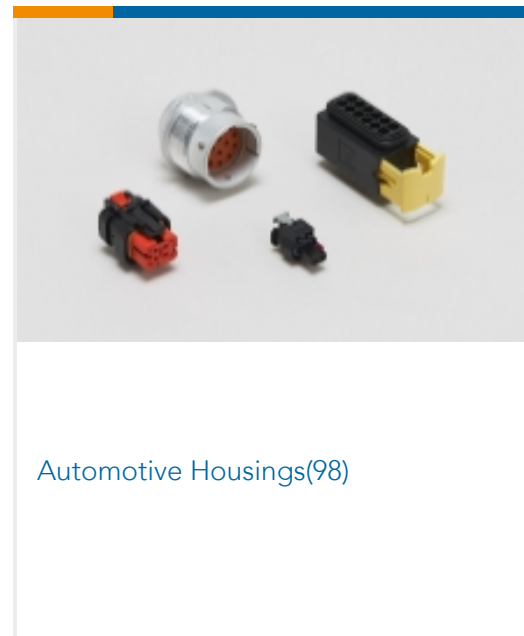
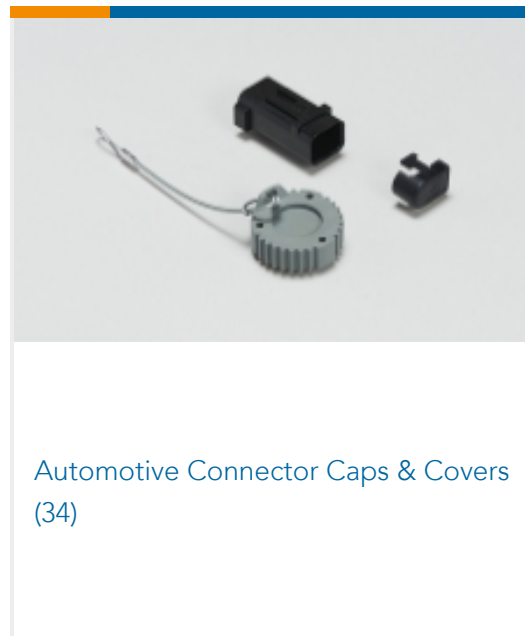



PCB Headers & Receptacles(42)

Customers Also Bought

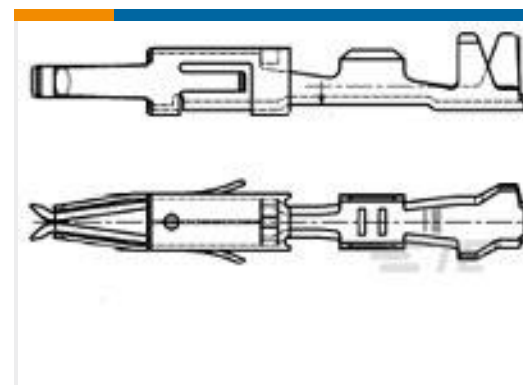
TE Part #1028-021-0205
DEUTSCH DTM BACKSHELLSTE Part #160533-2
110 FASTON,REC.,20-17 AWG,TPBRTE Part #HD36-18-14PE
PLG, 14P, AL, E, 16, PTE Part #1011-234-0305
BKSHL, 3P, BLK, REC, RA, NW6/7.5/8.5 /10TE Part #DTMH06-3SA
PLG, 3P, BLK, N, HI TEMP, ATE Part #969022-1
MT3 REC 1.6 Contact SRC AuTE Part #160928-4
FF 250 REC 0.5-1.0MM2 TPPBTE Part #HC5737
70MM2 NEGBAT LEAD 1/4" UNC
THREADTE Part #514162-5
CONVEYOR BELT 4M, TYPE 2P8005 /OPU

Documents

Product Drawings

[BKSHL, 3P, BLK, PLG, ST, NW 8.5](#)

English

CAD Files

[3D PDF](#)

3D

Customer View Model

[ENG_CVM_CVM_1028-005-0305_99_c-1028-005-0305-99.2d_dxf.zip](#)



English

Customer View Model

[ENG_CVM_CVM_1028-005-0305_99_c-1028-005-0305-99.3d_igs.zip](#)

English

Customer View Model

[ENG_CVM_CVM_1028-005-0305_99_c-1028-005-0305-99.3d_stp.zip](#)

English

By downloading the CAD file I accept and agree to the [Terms and Conditions](#) of use.

Datasheets & Catalog Pages

[ICT Terminals and Connectors Catalogue](#)

English

[CONNECTOR SELECTOR](#)

English

Product Specifications

[Application Specification](#)

English