

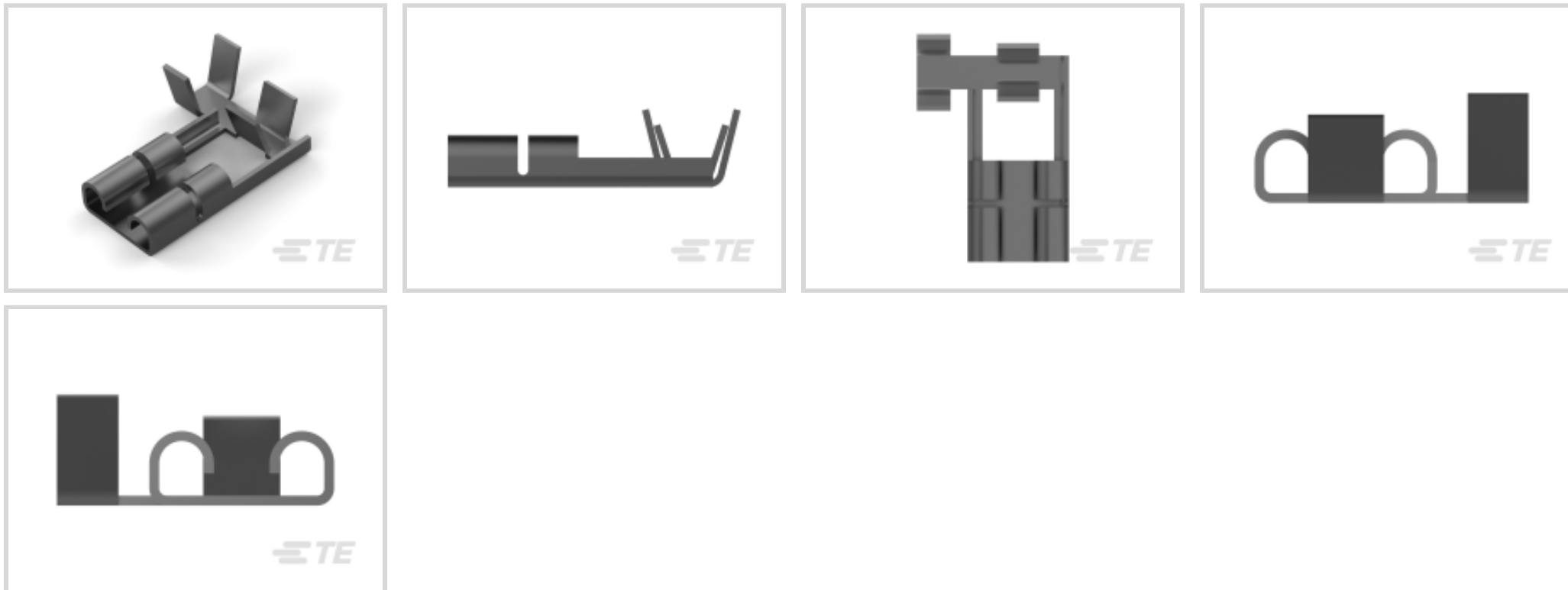

Terminals & Splices > Quick Disconnects



Quick Disconnect Terminal Type: **Receptacle**

Wire Size: 1 – 2.5 mm²

Mating Tab Width: 6.35 mm [.25 in]

Mating Tab Thickness: .81 mm [.032 in]

Features

Product Type Features

Terminates To	Wire & Cable
Wire Stop	No
Wire/Cable Type	Regular Wire
Insertion Force	Low
Sealable	No

Configuration Features

Connection Capacity	Single
---------------------	--------

Contact Features

Quick Disconnect Terminal Type	Receptacle
Mating Tab Width	6.35 mm [.25 in]
Mating Tab Thickness	.81 mm [.032 in]
Terminal Orientation	Flag
Contact Base Material	Brass
Terminal Plating Material	Tin
Crimp Type	F-Crimp



Barrel Type	Open
-------------	------

Mechanical Attachment

Wire Insulation Support	With
-------------------------	------

Dimensions

Accepts Wire Insulation Diameter Range	2.5 – 3.81 mm [.098 – .15 in]
--	-------------------------------

Overall Length	14.4 mm [.567 in]
----------------	-------------------

Receptacle Terminal Stock Thickness	.41 mm [.016 in]
-------------------------------------	------------------

Wire Size	1 – 2.5 mm ²
-----------	-------------------------

Usage Conditions

Insulation Option	Uninsulated
-------------------	-------------

Operating Temperature Range	-40 – 110 °C [-40 – 230 °F]
-----------------------------	-----------------------------

Packaging Features

Packaging Quantity	4000
--------------------	------

Packaging Method	Strip/Reel
------------------	------------

Other

Comment	Can replace FASTON receptacle base p/n 180397.
---------	--

Product Compliance

[For compliance documentation, visit the product page on TE.com>](#)

EU RoHS Directive 2011/65/EU	Compliant
------------------------------	-----------

EU ELV Directive 2000/53/EC	Compliant
-----------------------------	-----------

China RoHS 2 Directive MIIT Order No 32, 2016	No Restricted Materials Above Threshold
---	---

EU REACH Regulation (EC) No. 1907/2006	Current ECHA Candidate List: JAN 2022 (223) Candidate List Declared Against: JAN 2022 (223) Does not contain REACH SVHC
--	---

Halogen Content	Low Halogen - Br, Cl, F, I < 900 ppm per homogenous material. Also BFR/CFR/PVC Free
-----------------	---

Solder Process Capability	Not applicable for solder process capability
---------------------------	--

Product Compliance Disclaimer

This information is provided based on reasonable inquiry of our suppliers and represents our current actual knowledge based on the information they provided. This information is subject to change. The part numbers that TE has identified as

EU RoHS compliant have a maximum concentration of 0.1% by weight in homogenous materials for lead, hexavalent chromium, mercury, PBB, PBDE, DBP, BBP, DEHP, DIBP, and 0.01% for cadmium, or qualify for an exemption to these limits as defined in the Annexes of Directive 2011/65/EU (RoHS2). Finished electrical and electronic equipment products will be CE marked as required by Directive 2011/65/EU. Components may not be CE marked. Additionally, the part numbers that TE has identified as EU ELV compliant have a maximum concentration of 0.1% by weight in homogenous materials for lead, hexavalent chromium, and mercury, and 0.01% for cadmium, or qualify for an exemption to these limits as defined in the Annexes of Directive 2000/53/EC (ELV). Regarding the REACH Regulation, the information TE provides on SVHC in articles for this part number is based on the latest European Chemicals Agency (ECHA) 'Guidance on requirements for substances in articles' posted at this URL: <https://echa.europa.eu/guidance-documents/guidance-on-reach>

Compatible Parts



TE Part # 1-100645-3
250 FASTON,REC.,14-17AWG, PHBZ



TE Part # 1855631-1
HDM/FA SAPR.110F.180F LM CUT



TE Part # 1855631-2
HDM/FA SAPR.110F.180F BENCH K CUT



TE Part # 1855631-3
HDM/FA SAPR.110F.180F BENCH G CUT



TE Part # 2-2151008-2
OCEAN_2.0_APPLICATOR-S-110F180F



TE Part # 2151008-2
OCEAN_2.0_APPLICATOR-S-110F180F



TE Part # 7-2151008-2
OCEAN_2.0_APPLICATOR-S-110F180F

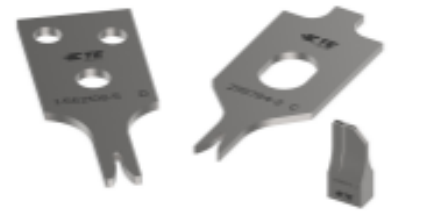

TE Part # 7-2151008-7
OCEAN_2.0_SPARE_PART_KIT-1110F180F

Also in the Series | FASTON 250



Compression Connectors(4)

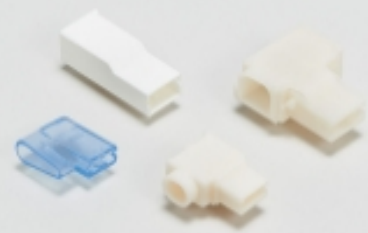

Crimp Terminal Housings(143)



Insertion & Extraction Tools(6)



Magnet Wire Terminals(1)



PCB Terminals(144)



Quick Disconnects(456)



Splices(4)

Customers Also Bought

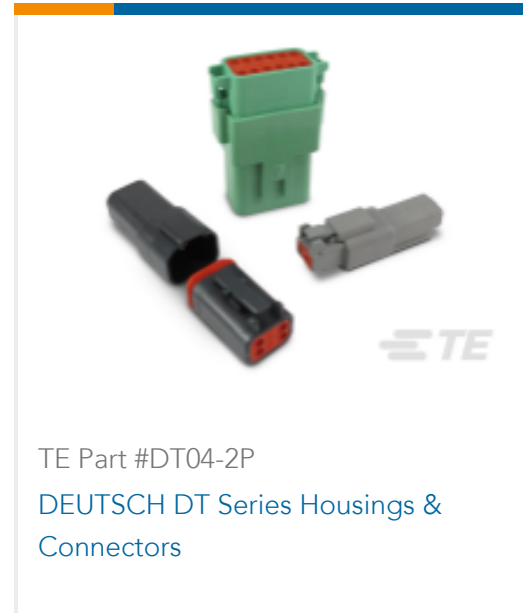
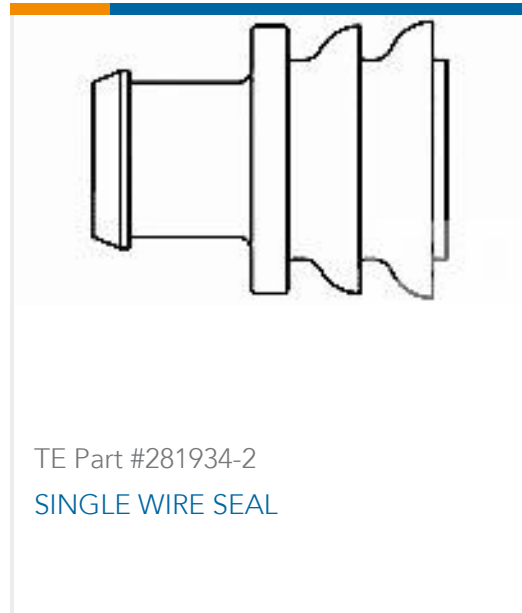

Documents

Product Drawings

250 FASTON,LIF REC.,14-17AWG,BR

English

CAD Files

Customer View Model

[ENG_CVM_CVM_100645-2_D.2d_dxf.zip](#)

English

3D PDF

3D

Customer View Model

[ENG_CVM_CVM_100645-2_D.3d_igs.zip](#)

English

Customer View Model

[ENG_CVM_CVM_100645-2_D.3d_stp.zip](#)

English

By downloading the CAD file I accept and agree to the [Terms and Conditions](#) of use.

Product Specifications

[Application Specification](#)

English

Product Environmental Compliance

[Product Compliance](#)

English

[Product Compliance](#)



English

[Agency Approvals](#)

[UL Report](#)

English