

MQS

TE Internal #: 1-953892-1

Housing for Female Terminals, Wire-to-Wire, 24 Position, .1 in [2.54 mm] Centerline, Gray, Signal, Cable Mount (Free-Hanging), MQS

[View on TE.com >](#)

Connectors > Automotive Connectors > Connector Housings > MQS, CONNECTOR HOUSING

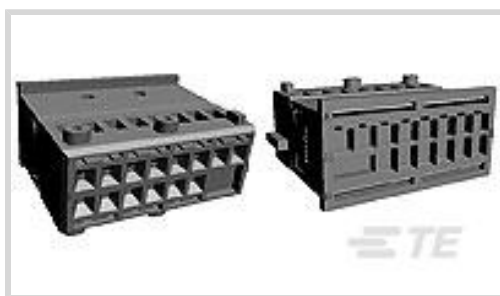
Connector & Housing Type: **Housing for Female Terminals**Mating Tab Width: **.63 mm [.025 in]**Connector System: **Wire-to-Wire**Number of Positions: **24**Centerline (Pitch): **2.54 mm [.1 in]**[All MQS, CONNECTOR HOUSING \(557\)](#)**Features****Product Type Features**

Connector & Housing Shape	Rectangular
Connector & Housing Type	Housing for Female Terminals
Connector System	Wire-to-Wire
Sealable	No
Hybrid Connector	No
Primary Locking Feature	On the Terminal

Configuration Features

Number of Positions	24
Number of Rows	2

Electrical Characteristics

Operating Voltage	16 VDC
Nominal Voltage Architecture	12 V

Body Features

Cable Exit Angle	180°
Body Material	PBT GF
Primary Product Color	Gray

Contact Features



Contact Size	.63mm
Contact Type	Receptacle
Mating Tab Width	.63 mm[.025 in]

Mechanical Attachment

Mounting Feature	Without
Terminal Position Assurance	Yes
Strain Relief	Without
Mating Alignment Type	Polarized
Mating Alignment	With
Connector Mounting Type	Cable Mount (Free-Hanging)

Housing Features

Centerline (Pitch)	2.54 mm[.1 in]
--------------------	----------------

Dimensions

Product Width	17.3 mm[.681 in]
Product Length	23.1 mm[.909 in]
Product Height	10.8 mm[.425 in]
Row-to-Row Spacing	6 mm[.236 in]

Usage Conditions

Operating Temperature (Max)	70 °C, 75 °C, 80 °C, 85 °C, 90 °C, 100 °C [158 °F][167 °F][176 °F][185 °F][194 °F][212 °F]
Operating Temperature Range	-40 – 100 °C[-40 – 212 °F]

Operation/Application

Circuit Application	Signal
---------------------	--------

Industry Standards

UL Flammability Rating	UL 94HB
------------------------	---------

Packaging Features

Packaging Method	Box
------------------	-----

Other

Serviceable	Yes
Connector Position Assurance Capable	No



Product Compliance

[For compliance documentation, visit the product page on TE.com>](#)

EU RoHS Directive 2011/65/EU	Compliant
EU ELV Directive 2000/53/EC	Compliant
China RoHS 2 Directive MIIT Order No 32, 2016	No Restricted Materials Above Threshold
EU REACH Regulation (EC) No. 1907/2006	Current ECHA Candidate List: JAN 2022 (223) Candidate List Declared Against: JAN 2022 (223) Does not contain REACH SVHC
Halogen Content	Low Halogen - Br, Cl, F, I < 900 ppm per homogenous material. Also BFR/CFR/PVC Free
Solder Process Capability	Not reviewed for solder process capability

Product Compliance Disclaimer

This information is provided based on reasonable inquiry of our suppliers and represents our current actual knowledge based on the information they provided. This information is subject to change. The part numbers that TE has identified as EU RoHS compliant have a maximum concentration of 0.1% by weight in homogenous materials for lead, hexavalent chromium, mercury, PBB, PBDE, DBP, BBP, DEHP, DIBP, and 0.01% for cadmium, or qualify for an exemption to these limits as defined in the Annexes of Directive 2011/65/EU (RoHS2). Finished electrical and electronic equipment products will be CE marked as required by Directive 2011/65/EU. Components may not be CE marked. Additionally, the part numbers that TE has identified as EU ELV compliant have a maximum concentration of 0.1% by weight in homogenous materials for lead, hexavalent chromium, and mercury, and 0.01% for cadmium, or qualify for an exemption to these limits as defined in the Annexes of Directive 2000/53/EC (ELV). Regarding the REACH Regulation, the information TE provides on SVHC in articles for this part number is based on the latest European Chemicals Agency (ECHA) 'Guidance on requirements for substances in articles' posted at this URL: <https://echa.europa.eu/guidance-documents/guidance-on-reach>

Compatible Parts



Also in the Series | MQS



Automotive Connector Caps & Covers (131)



Automotive Connector EMC Shielding (2)

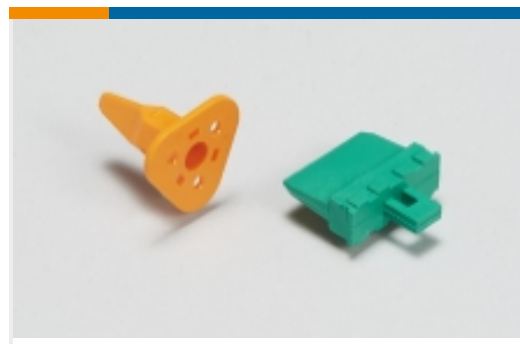

Automotive Connector Locks & Position Assurance(29)

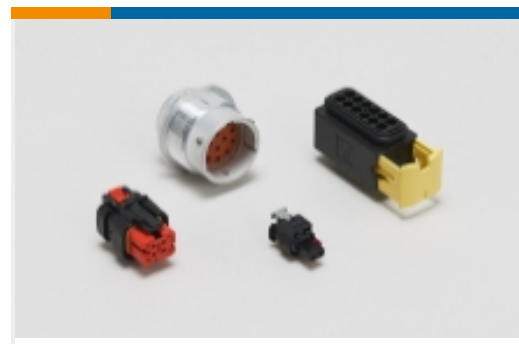

Automotive Housings(489)



Automotive Seals & Cavity Plugs(26)



Automotive Terminals(96)



Insertion & Extraction Tools(42)



Other Automotive Connector Accessories(13)

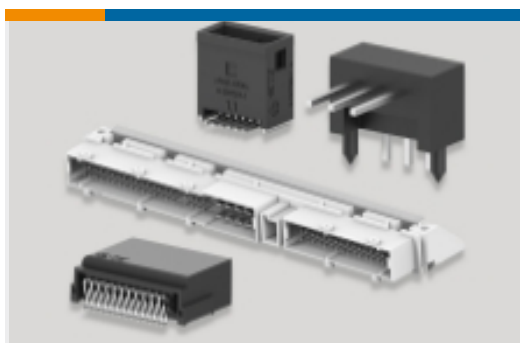

PCB Headers & Receptacles(207)

Customers Also Bought



TE Part #1394871-1
MQS DICHTSTOPFEN



TE Part #927831-2
SPT REC 6.3 Contact SRC Sn



TE Part #1-1718562-1
REC. HSG.,4POSN.,RAD.SEAL,AMP
MCP2.8K



TE Part #881757-1
2P JR TIMER ASS'Y



TE Part #1-1801175-1
2W RECEPTACLE HP CONNECTOR
BLACK

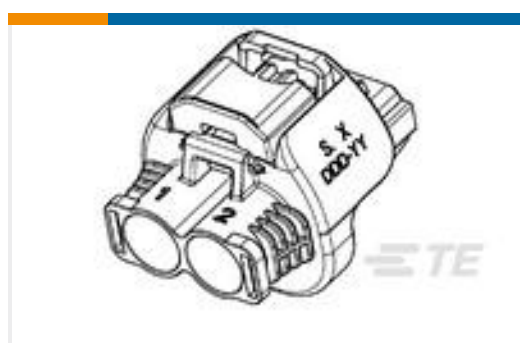

TE Part #1544978-2
RECEPT HSG ASSY, 8MM NG1+, 2W,
SEALED

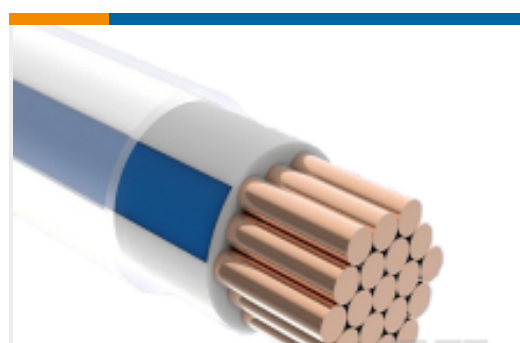

TE Part #CD41663001
ACW0219-1.00-60(NS)



TE Part #1544221-1
COSSE DE PUISSANCE

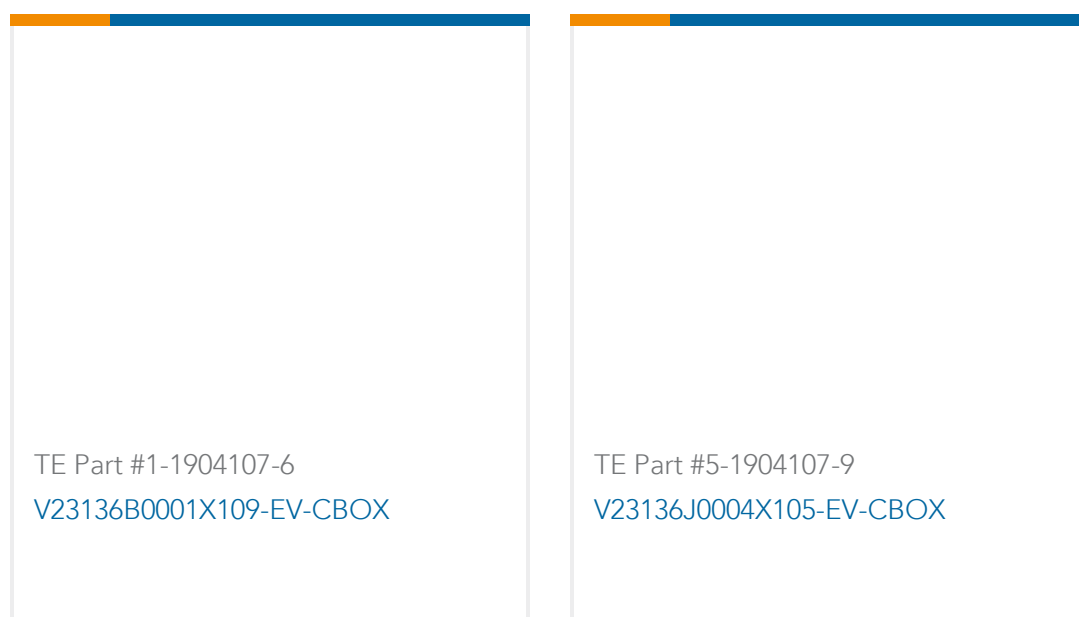

Documents

Product Drawings

16/8W+4SC MQS SOCKET HSG

French

CAD Files

Customer View Model

[ENG_CVM_1-953892-1_C.3d_igs.zip](#)

English

Customer View Model

[ENG_CVM_1-953892-1_C.3d_stp.zip](#)

English

Customer View Model

[ENG_CVM_1-953892-1_C.2d_dxf.zip](#)

English

3D PDF

English

By downloading the CAD file I accept and agree to the [Terms and Conditions](#) of use.

Datasheets & Catalog Pages

Micro Quadlok Interconnection System (MQS)

English

Product Specifications

CONNECTIQUE MQS (16 VOIES A 8 VOIES + 4 SHUNT) POUR RACCORDEMENT SOUS SIEGE

English

Product Specification

English

Instruction Sheets

Instruction Sheet (non U.S.)

French

PRECONISATION DE CONTROLE PORTE-CLIPS MQS 16 VOIES POUR RACCORDEMENT SOUS SIEGE

English

Instruction Sheet (non U.S.)

English

1-953892-1

Housing for Female Terminals, Wire-to-Wire, 24 Position, .1 in [2.54 mm] Centerline,
Gray, Signal, Cable Mount (Free-Hanging), MQS

