

1-964302-3 ✓ ACTIVE

AMP | Timer Connector System

TE Internal #: 1-964302-3

Automotive Terminals, Tab, Mating Tab Width 2.8 mm [.11 in], Tab Thickness .031 in [.8 mm], 17 – 13 AWG Wire Size, Timer Connector System

[View on TE.com >](#)



Terminals & Splices > Automotive Terminals > TIMER, RECEPTACLE AND TAB



Terminal Type: **Tab**

Mating Tab Width: **2.8 mm [.11 in]**

Mating Tab Thickness: **.8 mm [.031 in]**

Terminal Transmits: **25 – 40 A (Power)**

Wire Size: **17 – 13 AWG**

[All TIMER, RECEPTACLE AND TAB \(346\)](#)

## Features

### Product Type Features

Sealable	Yes
Primary Locking Feature	Locking Lance

### Body Features

Terminal Seal Type	Single Wire Seal (SWS)
--------------------	------------------------

### Contact Features

Contact Size	2.8mm
Contact Fabrication	Stamped & Formed
Typical Current Rating	30 A
Crimp Type	F-Crimp
Terminal Type	Tab
Mating Tab Width	2.8 mm[.11 in]
Mating Tab Thickness	.8 mm[.031 in]
Interface Plating	Gold (Au)
Contact Termination Area Plating Material	Tin (Sn)

### Termination Features

Termination Method to Wire & Cable	Crimp
------------------------------------	-------



Product Terminates To

Wire

### Dimensions

Wire Size

1 – 2.5 mm<sup>2</sup>

Wire Size Search

13 AWG, 14 AWG, 15 AWG, 16 AWG, 17 AWG

Wire Insulation Diameter

2.2 – 2.4 mm [.134 in]

### Usage Conditions

Insulation Option

Uninsulated

Operating Temperature (Max)

80 °C, 85 °C, 90 °C, 100 °C, 105 °C, 110 °C, 120 °C, 125 °C, 130 °C, 140 °C, 145 °C, 150 °C [176 °F][185 °F][194 °F][212 °F][221 °F][230 °F][248 °F][257 °F][266 °F][284 °F][293 °F][302 °F]

Operating Temperature Range

-40 – 150 °C [-40 – 302 °F]

### Operation/Application

Compatible With Wire Base Material

Copper

### Industry Standards

Agency/Standard

IEC 664/664A (DIN VDE 0110)

### Packaging Features

Packaging Method

Reel

Packaging Quantity

3300

### Other

Terminal Transmits

25 – 40 A (Power)

### Product Compliance

For compliance documentation, visit the product page on [TE.com](https://www.te.com)>

EU RoHS Directive 2011/65/EU

Compliant

EU ELV Directive 2000/53/EC

Compliant

China RoHS 2 Directive MIIT Order No 32, 2016

No Restricted Materials Above Threshold

EU REACH Regulation (EC) No. 1907/2006

Current ECHA Candidate List: JAN 2022 (223)  
Candidate List Declared Against: JAN 2022 (223)  
Does not contain REACH SVHC

Halogen Content

Low Halogen - Br, Cl, F, I &lt; 900 ppm per homogenous material. Also BFR/CFR/PVC

Free

Solder Process Capability

Not applicable for solder process capability

Product Compliance Disclaimer

This information is provided based on reasonable inquiry of our suppliers and represents our current actual knowledge based on the information they provided. This information is subject to change. The part numbers that TE has identified as EU RoHS compliant have a maximum concentration of 0.1% by weight in homogenous materials for lead, hexavalent chromium, mercury, PBB, PBDE, DBP, BBP, DEHP, DIBP, and 0.01% for cadmium, or qualify for an exemption to these limits as defined in the Annexes of Directive 2011/65/EU (RoHS2). Finished electrical and electronic equipment products will be CE marked as required by Directive 2011/65/EU. Components may not be CE marked. Additionally, the part numbers that TE has identified as EU ELV compliant have a maximum concentration of 0.1% by weight in homogenous materials for lead, hexavalent chromium, and mercury, and 0.01% for cadmium, or qualify for an exemption to these limits as defined in the Annexes of Directive 2000/53/EC (ELV). Regarding the REACH Regulation, the information TE provides on SVHC in articles for this part number is based on the latest European Chemicals Agency (ECHA) 'Guidance on requirements for substances in articles' posted at this URL: <https://echa.europa.eu/guidance-documents/guidance-on-reach>

## Compatible Parts



TE Part # 4-1579007-3  
EXTRACTION TOOL KIT



TE Part # 1-1579007-6  
EXTRACTION TOOL



TE Part # 828905-1  
SINGLE-WIRE-SEAL(5MM HOLE)



TE Part # 2305570-1  
TERMINAL CUTTER, SIDE FEED



TE Part # 284873-1  
24 POS CAP HOUSING ASS'Y



TE Part # CAT-T4827-CH8172  
TIMER, CONNECTOR HOUSING



TE Part # 963293-1  
SEALING F JPT+2,8

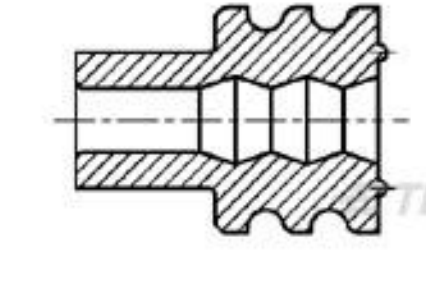

TE Part # 963292-1  
WIRE SEALING 2,2



TE Part # 1579008-9  
INSERTION TOOL



TE Part # 2-2151063-1  
OCEAN\_2.0\_APPLICATOR-S-100F165O



TE Part # 2-2151063-2  
OCEAN\_2.0\_APPLICATOR-S-100F165O



TE Part # 2151063-1  
OCEAN\_2.0\_APPLICATOR-S-100F165O



TE Part # 2151063-2  
OCEAN\_2.0\_APPLICATOR-S-100F165O



TE Part # 5-2151063-1  
OCEAN\_2.0\_APPLICATOR-S-100F165O



TE Part # 5-2151063-2  
OCEAN\_2.0\_APPLICATOR-S-100F165O



TE Part # 7-2151063-1  
OCEAN\_2.0\_APPLICATOR-S-100F165O



TE Part # 7-2151063-2  
OCEAN\_2.0\_APPLICATOR-S-100F165O



TE Part # 7-2151063-7  
OCEAN\_2.0\_SPARE\_PART\_KIT-100F165O



TE Part # 7-2266074-7  
OC-100F165O-752-CRIMPTOOLINGKIT

## Also in the Series | Timer Connector System



Automotive Connector Caps & Covers (11)



Automotive Connector Locks & Position Assurance(16)



Automotive Housings(219)



Automotive Seals & Cavity Plugs(31)



Automotive Terminals(140)



Crimp Terminal Housings(13)



Insertion & Extraction Tools(20)

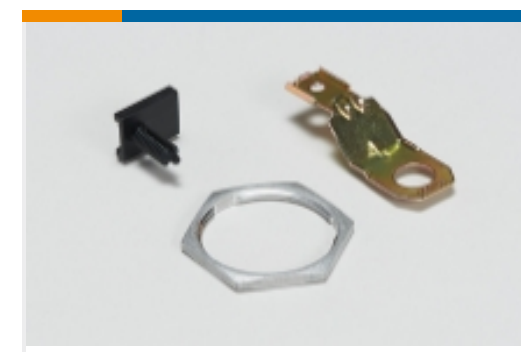

Other Automotive Connector Accessories(1)



PCB Headers & Receptacles(78)

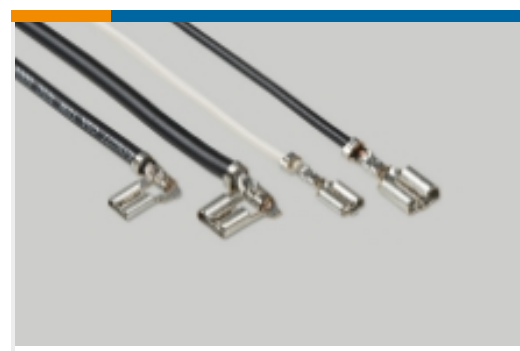

Quick Disconnects(4)

## Customers Also Bought

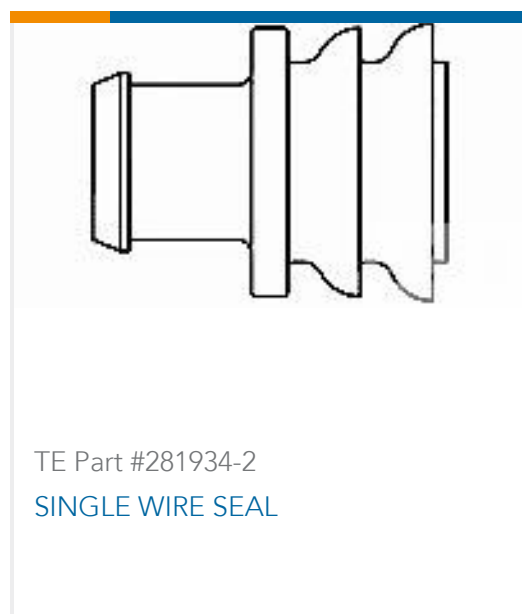

TE Part #281934-2  
SINGLE WIRE SEAL

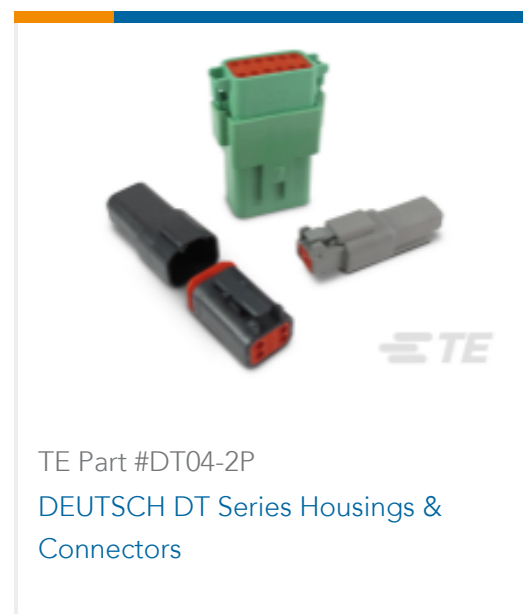

TE Part #DT04-2P  
DEUTSCH DT Series Housings &  
Connectors



TE Part #W2S  
DEUTSCH DT WEDGELOCKS



TE Part #0460-202-16141  
DEUTSCH SOLID CONTACTS



TE Part #282104-1  
AMP SUPERSEAL 1.5MM,  
CONNECTOR HOUSING



TE Part #114017-ZZ  
SEALING PLUG, SIZE 12/16, WHT

## Documents

### Product Drawings

[TAB A 2.8x0.8 CONTACT CS SWS Au](#)

English

[TAB A 2.8x0.8 CONTACT CS SWS Au](#)

English

### CAD Files

Customer View Model

[ENG\\_CVM\\_CVM\\_1-964302-3\\_C.2d\\_dxf.zip](#)

English

[3D PDF](#)

3D

Customer View Model

[ENG\\_CVM\\_CVM\\_1-964302-3\\_C.3d\\_igs.zip](#)

English

Customer View Model

[ENG\\_CVM\\_CVM\\_1-964302-3\\_C.3d\\_stp.zip](#)

English

By downloading the CAD file I accept and agree to the [Terms and Conditions](#) of use.

### Datasheets & Catalog Pages

[Timer Interconnection System](#)

English

### Product Specifications

[Application Specification](#)

German



[Application Specification](#)

English

[Application Specification](#)

English