

1-967601-1 ✓ ACTIVE

### Timer Connector System

TE Internal #: 1-967601-1

TE Internal Description: MESSERLEISTE3,0 10P

LOW & MEDIUM POWER HEADER

[View on TE.com >](#)

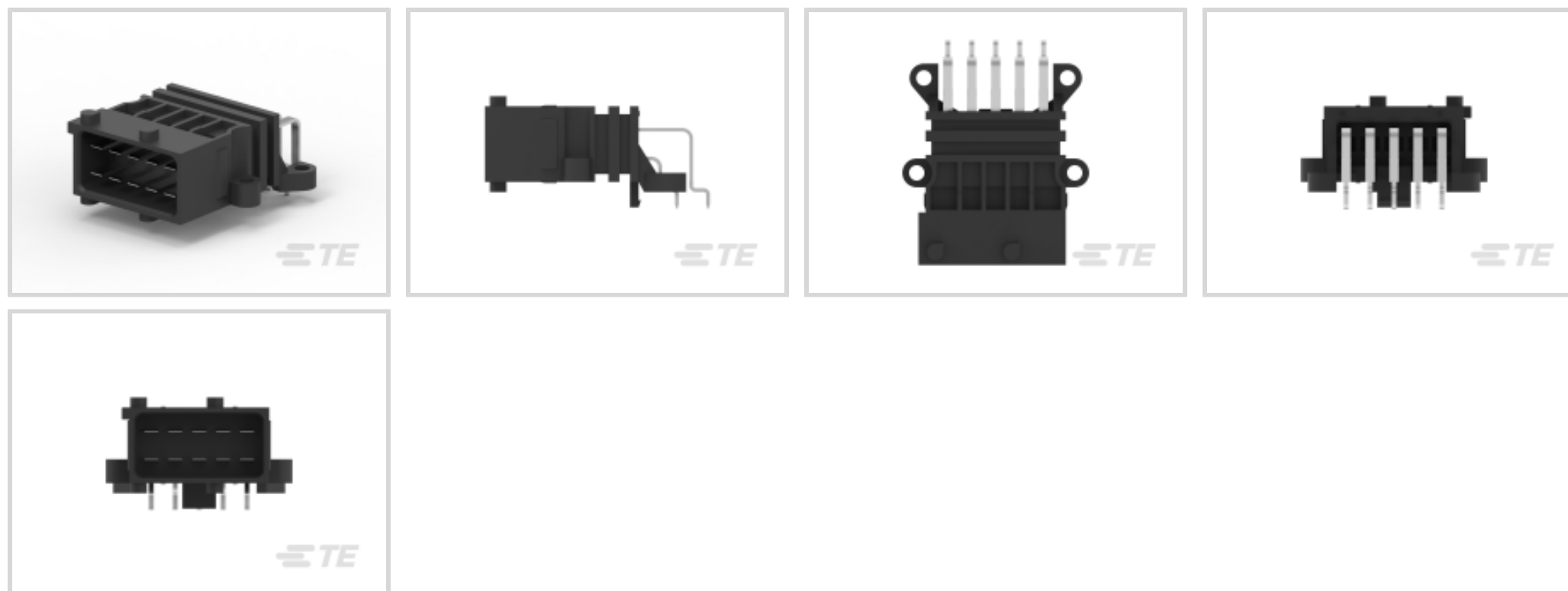

#### All LOW & MEDIUM POWER HEADER (154)

### Product Compliance

[For compliance documentation, visit the product page on TE.com>](#)

EU RoHS Directive 2011/65/EU	Compliant
EU ELV Directive 2000/53/EC	Compliant
China RoHS 2 Directive MIIT Order No 32, 2016	No Restricted Materials Above Threshold
EU REACH Regulation (EC) No. 1907/2006	Current ECHA Candidate List: JAN 2022 (223) Candidate List Declared Against: JUL 2021 (219) SVHC > Threshold: Not Yet Reviewed
Halogen Content	Low Halogen - Br, Cl, F, I < 900 ppm per homogenous material. Also BFR/CFR/PVC Free
Solder Process Capability	Not applicable for solder process capability

#### Product Compliance Disclaimer

This information is provided based on reasonable inquiry of our suppliers and represents our current actual knowledge based on the information they provided. This information is subject to change. The part numbers that TE has identified as EU RoHS compliant have a maximum concentration of 0.1% by weight in homogenous materials for lead, hexavalent chromium, mercury, PBB, PBDE, DBP, BBP, DEHP, DIBP, and 0.01% for cadmium, or qualify for an exemption to these limits as defined in the Annexes of Directive 2011/65/EU (RoHS2). Finished electrical and electronic equipment products will be CE marked as required by Directive 2011/65/EU. Components may not be CE marked. Additionally, the part numbers that TE has identified as EU ELV compliant have a maximum concentration of 0.1% by weight in homogenous materials for lead, hexavalent chromium, and mercury, and 0.01% for cadmium, or qualify for an exemption to these limits as defined in the Annexes of Directive 2000/53/EC (ELV). Regarding the REACH Regulation, the information TE provides on SVHC in articles for this part number is based on the latest European Chemicals Agency (ECHA) 'Guidance on requirements for substances in articles' posted at this URL: <https://echa.europa.eu/guidance-documents/guidance-on-reach>

## Compatible Parts



TE Part # 963213-1  
Dichtung F 962352



TE Part # CAT-T4827-CH8172  
TIMER, CONNECTOR HOUSING

## Also in the Series | Timer Connector System



Automotive Connector Caps & Covers (11)



Automotive Connector Locks & Position Assurance (16)



Automotive Housings (219)



Automotive Seals & Cavity Plugs (31)



Automotive Terminals (140)



Crimp Terminal Housings (13)



Insertion & Extraction Tools (20)



Other Automotive Connector Accessories (1)



PCB Headers & Receptacles (78)

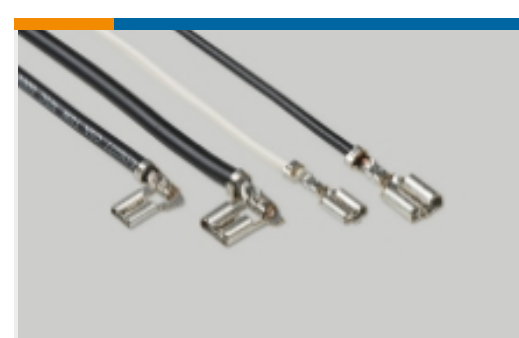

Quick Disconnects (4)

## Customers Also Bought



## Documents

### Product Drawings

[MESSERLEISTE3,0 10P](#)

English

### CAD Files

Customer View Model

[ENG\\_CVM\\_1-967601-1\\_D.3d\\_igs.zip](#)

English

Customer View Model

[ENG\\_CVM\\_1-967601-1\\_D.3d\\_stp.zip](#)

English

Customer View Model

[ENG\\_CVM\\_1-967601-1\\_D.2d\\_dxf.zip](#)

English

### 3D PDF

English

By downloading the CAD file I accept and agree to the [Terms and Conditions](#) of use.