

1-104257-1 ✓ ACTIVE

AMPMODU | AMPMODU MTE

TE Internal #: 1-104257-1

Housing, Receptacle, Wire-to-Board, 12 Position, 2.54 mm [.1 in]
Centerline, Crimp / Insulation Displacement (IDC), 1 Row, Black,
AMPMODU MTE

[View on TE.com >](#)



Connectors > PCB Connectors > Wire-to-Board Connectors > Wire-to-Board Connector Assemblies & Housings



Connector Product Type: **Housing**

Connector & Housing Type: **Receptacle**

Connector System: **Wire-to-Board**

Number of Positions: **12**

Centerline (Pitch): **2.54 mm [.1 in]**

Features

Product Type Features

Connector Product Type	Housing
Connector & Housing Type	Receptacle
Connector System	Wire-to-Board
Sealable	No
Connector & Contact Terminates To	Wire & Cable

Configuration Features

Number of Positions	12
Number of Rows	1

Electrical Characteristics

Dielectric Withstanding Voltage (Max)	600 VAC
Insulation Resistance	5000 MΩ
Operating Voltage	267 V

Contact Features

Contact Layout	Inline
Contact Retention Within Housing	With
Contact Type	Socket
Contact Current Rating (Max)	3 A

Termination Features



Termination Method to Wire & Cable	Crimp, Insulation Displacement (IDC)
------------------------------------	--------------------------------------

Mechanical Attachment

Strain Relief	Without
Contact Retention Type Within Housing	Locking Lance
Panel Mount Feature	Without
PCB Mount Retention	Without
Mating Retention Type	Latch
Mating Retention	With
Connector Mounting Type	Cable Mount (Free-Hanging)

Housing Features

Housing Material	Thermoplastic
Centerline (Pitch)	2.54 mm [.1 in]
Housing Color	Black

Dimensions

Connector Length	30.43 mm [1.198 in]
Connector Height	6.73 mm [.265 in]

Usage Conditions

Operating Temperature Range	-65 – 105 °C [-85 – 221 °F]
-----------------------------	-----------------------------

Operation/Application

Circuit Application	Signal
---------------------	--------

Industry Standards

Glow Wire Rating	Standard Part - Not Glow Wire
UL Flammability Rating	UL 94V-0

Packaging Features

Packaging Quantity	500
Packaging Method	Bag

Other

Comment	Refer to AMPMODU contacts for crimp snap-in replacement receptacle or pin contacts.
---------	---

Product Compliance

For compliance documentation, visit the product page on [TE.com](https://www.te.com)>











EU RoHS Directive 2011/65/EU	Compliant
EU ELV Directive 2000/53/EC	Compliant
China RoHS 2 Directive MIIT Order No 32, 2016	No Restricted Materials Above Threshold
EU REACH Regulation (EC) No. 1907/2006	Current ECHA Candidate List: JAN 2022 (223) Candidate List Declared Against: JAN 2022 (223) Does not contain REACH SVHC
Halogen Content	Not Low Halogen - contains Br or Cl > 900 ppm.
Solder Process Capability	Not applicable for solder process capability

Product Compliance Disclaimer

This information is provided based on reasonable inquiry of our suppliers and represents our current actual knowledge based on the information they provided. This information is subject to change. The part numbers that TE has identified as EU RoHS compliant have a maximum concentration of 0.1% by weight in homogenous materials for lead, hexavalent chromium, mercury, PBB, PBDE, DBP, BBP, DEHP, DIBP, and 0.01% for cadmium, or qualify for an exemption to these limits as defined in the Annexes of Directive 2011/65/EU (RoHS2). Finished electrical and electronic equipment products will be CE marked as required by Directive 2011/65/EU. Components may not be CE marked. Additionally, the part numbers that TE has identified as EU ELV compliant have a maximum concentration of 0.1% by weight in homogenous materials for lead, hexavalent chromium, and mercury, and 0.01% for cadmium, or qualify for an exemption to these limits as defined in the Annexes of Directive 2000/53/EC (ELV). Regarding the REACH Regulation, the information TE provides on SVHC in articles for this part number is based on the latest European Chemicals Agency (ECHA) 'Guidance on requirements for substances in articles' posted at this URL: <https://echa.europa.eu/guidance-documents/guidance-on-reach>

Compatible Parts

 <p>TE Part # 1-103653-1 12 MTE SHRD PIN HSG SR LATCH</p>	 <p>TE Part # 104479-9 SHORT POINT CONT 15 DPLX STMPD LF</p>	 <p>TE Part # 1-104480-3 SHORT POINT CONT 30 DPLX STMPD LF</p>	 <p>TE Part # 104479-8 SHORT POINT CONT PLTD SN</p>
 <p>TE Part # 1-104480-2 SHORT POINT CONT 15 DPLX STMPD LF</p>	 <p>TE Part # 1-104481-1 SHORT POINT CONT 30 DPLX STMPD LF</p>	 <p>TE Part # 1-104481-0 SHORT POINT CONT 15 DPLX STMPD LF</p>	 <p>TE Part # 1-147750-1 12 MTE HDR SRST W/PCB TIN</p>

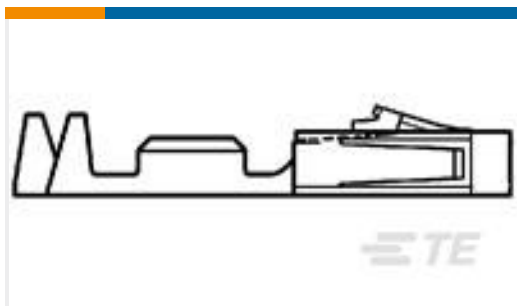

TE Part # 1-104479-0
SHORT POINT CONT 30 DPLX
STMPD LF



TE Part # 1825574-2
12 MTE VERT SMT HDR, w/o caps or
bdlocks



TE Part # 1825514-3
12 MTE VERT SMT HDR, Lead-Free



TE Part # 6-147750-1
12 MTE HDR SRST W/PCB LF

Also in the Series | AMPMODU MTE



Insertion & Extraction Tools(2)



PCB Connector Shrouds(40)

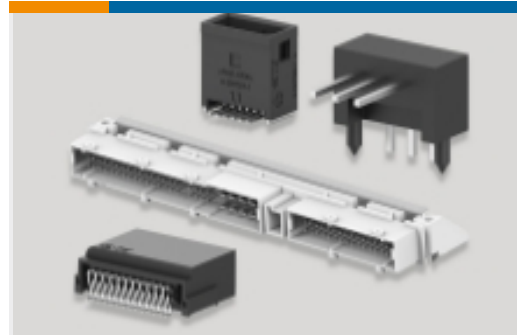

PCB Headers & Receptacles(763)



Ribbon Connector Accessories(1)



Standard Rectangular Connectors(2)

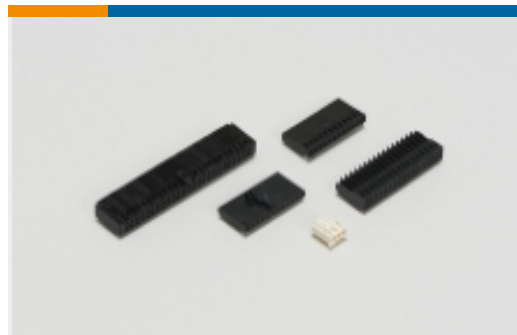

Wire-to-Board Connector Assemblies
& Housings(585)



Wire-to-Board Connector Contacts(32)

Customers Also Bought

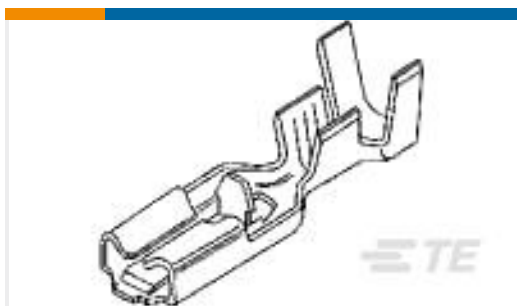

TE Part #63809-1
PL 250 TERMINAL REC 18-14 AWG
TPBR



TE Part #103669-2
03 MTE HDR SRST LATCH W/HLDWN



TE Part #322996
TERMINAL, SOLIS SPD 16-14 6

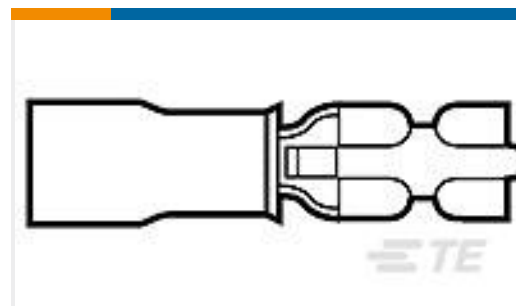

TE Part #8-640931-1
RECEPT, PIDG FASTON 16-14 110



TE Part #1721531-7
PCJ-112D3MH,303



TE Part #1955415-1
3P CLUSTER BLOCK HOUSING

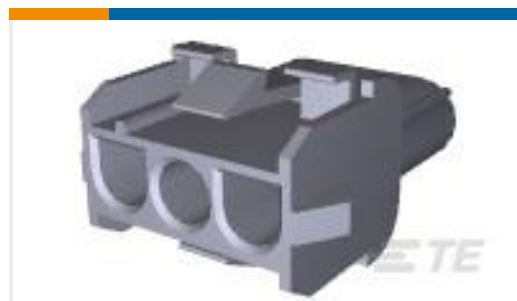

TE Part #1-480701-1
03P UMNL CAP HSG BRN



TE Part #CG3720-000
CI-5RL301



Documents

Product Drawings

[12 MTE RCPT HSG SR LATCH .100](#)

English

CAD Files

[3D PDF](#)

3D

[Customer View Model](#)

[ENG_CVM_CVM_1-104257-1_AH.2d_dxf.zip](#)

English

[Customer View Model](#)

[ENG_CVM_CVM_1-104257-1_AH.3d_igs.zip](#)

English

[Customer View Model](#)

[ENG_CVM_CVM_1-104257-1_AH.3d_stp.zip](#)

English

By downloading the CAD file I accept and agree to the [Terms and Conditions](#) of use.

Datasheets & Catalog Pages

[AMP MODU MTE Section of Catalog 1307819](#)

English

[AMPMODU_INTERCONNECTION_SYSTEM_SECTION5_CONT](#)

English

[AMPMODU MTE INTERCONNECT SYSTEM](#)

English

Product Specifications

[Application Specification](#)

English

Product Environmental Compliance

[MD_1-104257-1_07272018332_dmtec](#)

English

[MD_1-104257-1_07272018332_dmtec](#)

English

1-104257-1

Housing, Receptacle, Wire-to-Board, 12 Position, 2.54 mm [.1 in] Centerline, Crimp /
Insulation Displacement (IDC), 1 Row, Black, AMPMODU MTE

