



Power Key 5.0

TE Internal #: 1-1376393-2

Rectangular Power Connectors, Housing, Plug, Wire-to-Board, 6 Position, .197 in [5 mm] Centerline, Wire & Cable, UL 94V-0, Power Key 5.0

[View on TE.com >](#)

Connectors > Power Connectors > Rectangular Power > Rectangular Power Connectors > STD Temp Power Key Plug

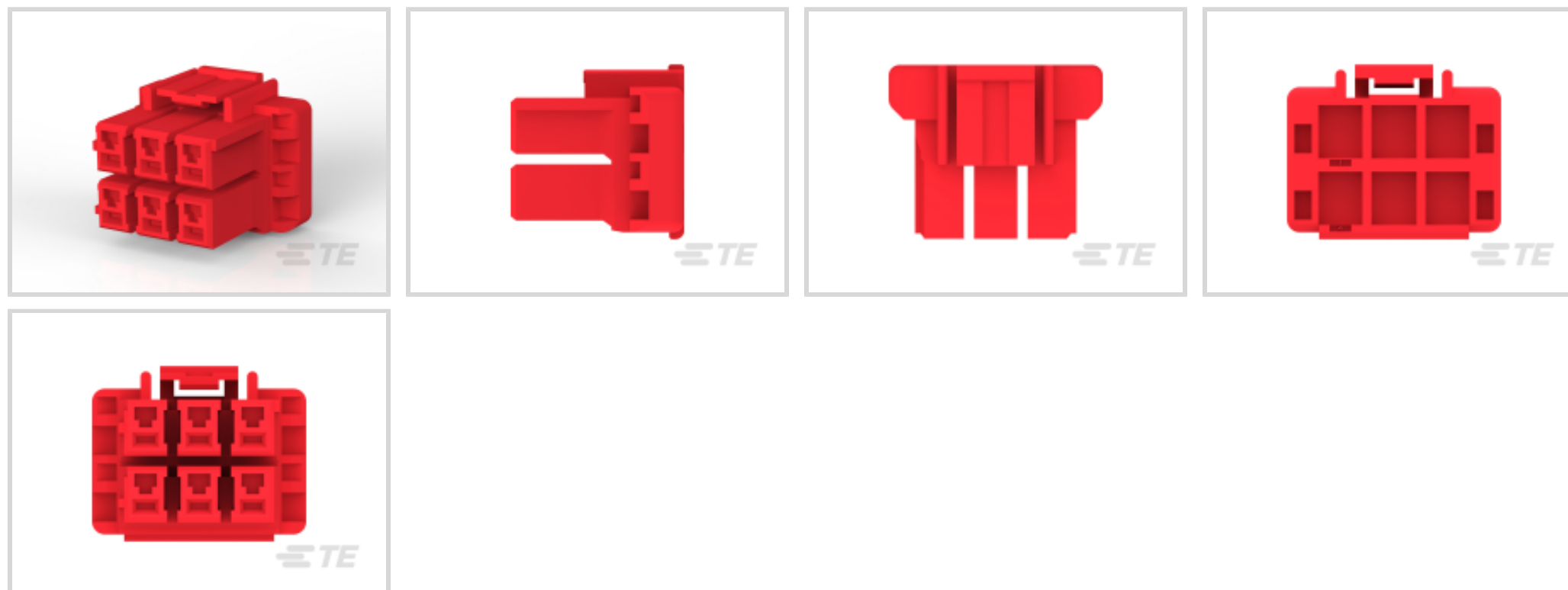

Rectangular Power Connector Type: **Housing**

Connector & Housing Type: **Plug**

Connector System: **Wire-to-Board**

Number of Positions: **6**

Centerline (Pitch): **5 mm [.197 in]**

[All STD Temp Power Key Plug \(34\)](#)

Features

Product Type Features

Rectangular Power Connector Type	Housing
Connector & Housing Type	Plug
Connector System	Wire-to-Board
Sealable	No
Connector & Contact Terminates To	Wire & Cable

Configuration Features

Number of Positions	6
Number of Rows	2

Electrical Characteristics

Operating Voltage	300 VAC
-------------------	---------

Contact Features

Contact Base Material	Copper Alloy
-----------------------	--------------



Contact Current Rating (Max)	10 A
Contact Retention Within Housing	Without
Contact Type	Receptacle

Termination Features

Termination Method to Wire & Cable	Crimp
------------------------------------	-------

Mechanical Attachment

Strain Relief	Without
Mating Alignment Type	Keyed
Mating Alignment	With
Panel Mount Feature	Without
PCB Mount Retention	Without
Connector Mounting Type	Cable Mount (Free-Hanging)
Mating Retention	With
Mating Retention Type	Latch

Housing Features

Centerline (Pitch)	5 mm [.197 in]
Housing Color	Red
Housing Material	Nylon 6/6 GF

Dimensions

Row-to-Row Spacing	6.2 mm [.244 in]
Width	16.2 mm [.638 in]
Accepts Wire Insulation Diameter Range	1.7 – 3.1 mm [.067 – .122 in]
Height	15.8 mm [.622 in]
Length	20 mm [.787 in]

Usage Conditions

Operating Temperature Range	-40 – 105 °C [-40 – 221 °F]
-----------------------------	-----------------------------

Operation/Application

Circuit Application	Power & Signal
---------------------	----------------

Industry Standards

UL Flammability Rating	UL 94V-0
Glow Wire Rating	Standard Part - Not Glow Wire
Agency/Standard Number	E28476



Agency/Standard	CSA, UL
UL Rating	Recognized
CSA File Number	LR 7189

Packaging Features

Packaging Method	Bag
Packaging Quantity	500

Other

For Use With	Receptacle Housing
--------------	--------------------

Product Compliance

[For compliance documentation, visit the product page on TE.com>](#)

EU RoHS Directive 2011/65/EU	Compliant
EU ELV Directive 2000/53/EC	Compliant
China RoHS 2 Directive MIIT Order No 32, 2016	No Restricted Materials Above Threshold
EU REACH Regulation (EC) No. 1907/2006	Current ECHA Candidate List: JAN 2022 (223) Candidate List Declared Against: JAN 2022 (223) Does not contain REACH SVHC
Halogen Content	Not Low Halogen - contains Br or Cl > 900 ppm.
Solder Process Capability	Not applicable for solder process capability

Product Compliance Disclaimer

This information is provided based on reasonable inquiry of our suppliers and represents our current actual knowledge based on the information they provided. This information is subject to change. The part numbers that TE has identified as EU RoHS compliant have a maximum concentration of 0.1% by weight in homogenous materials for lead, hexavalent chromium, mercury, PBB, PBDE, DBP, BBP, DEHP, DIBP, and 0.01% for cadmium, or qualify for an exemption to these limits as defined in the Annexes of Directive 2011/65/EU (RoHS2). Finished electrical and electronic equipment products will be CE marked as required by Directive 2011/65/EU. Components may not be CE marked. Additionally, the part numbers that TE has identified as EU ELV compliant have a maximum concentration of 0.1% by weight in homogenous materials for lead, hexavalent chromium, and mercury, and 0.01% for cadmium, or qualify for an exemption to these limits as defined in the Annexes of Directive 2000/53/EC (ELV). Regarding the REACH Regulation, the information TE provides on SVHC in articles for this part number is based on the latest European Chemicals Agency (ECHA) 'Guidance on requirements for substances in articles' posted at this URL: <https://echa.europa.eu/guidance-documents/guidance-on-reach>

Compatible Parts

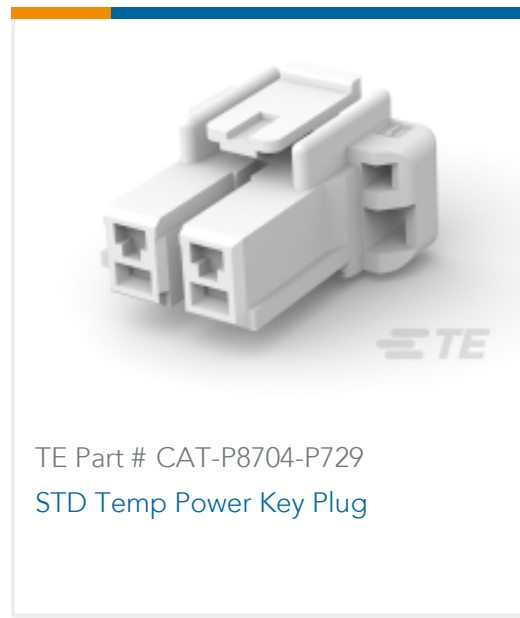

Also in the Series | **Power Key 5.0**

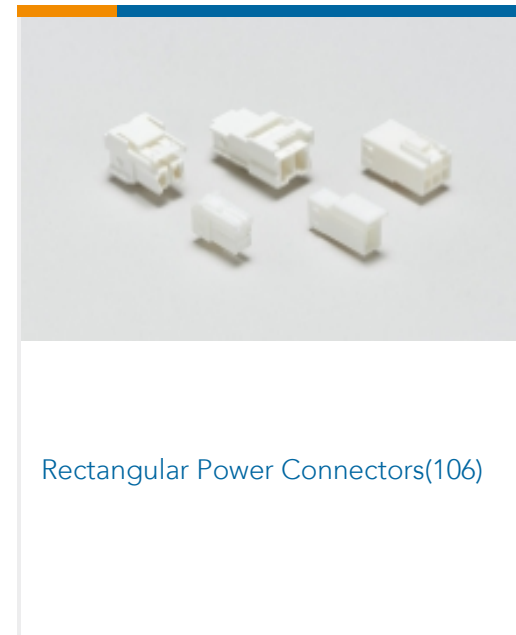
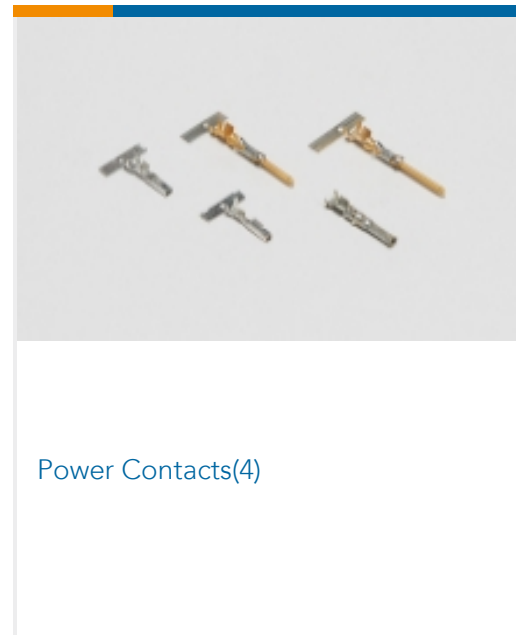
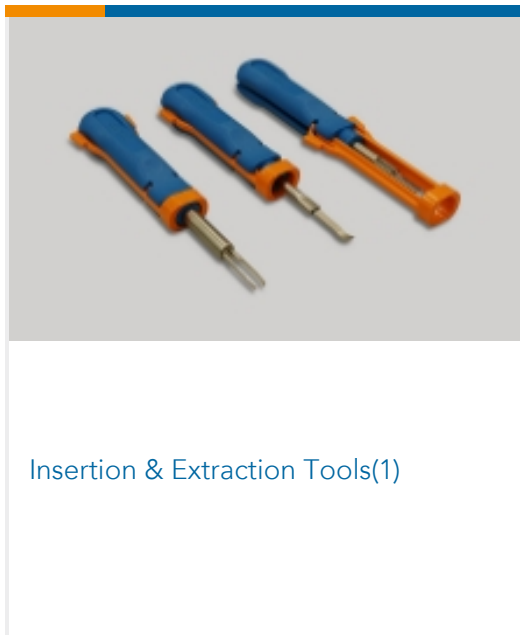

Customers Also Bought

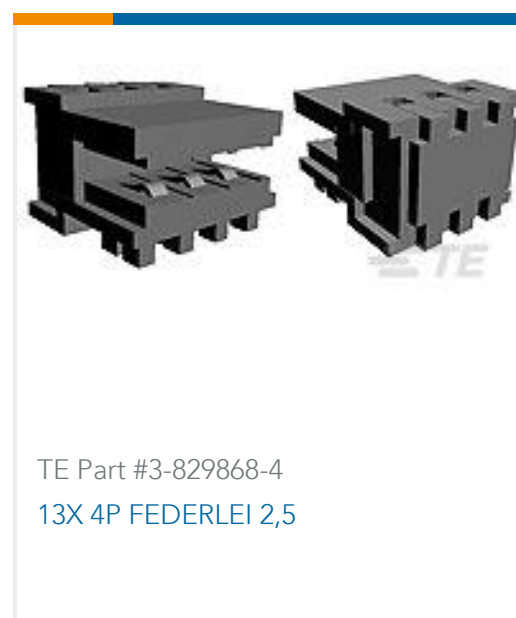
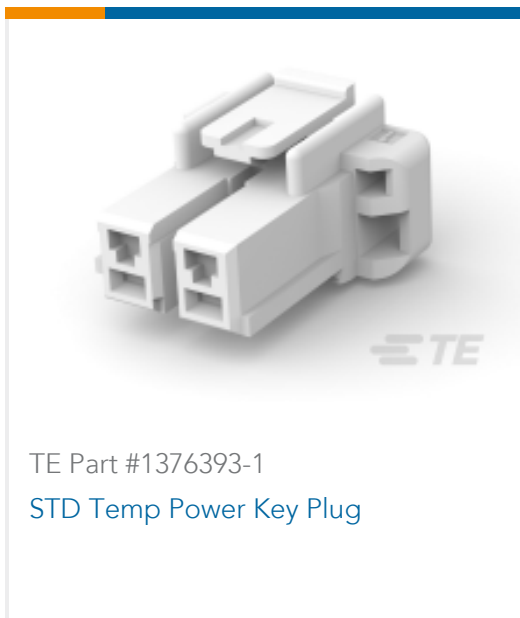

Documents

Product Drawings

5MM POWER KEY 6P PLUG HSG RED

English

CAD Files

3D PDF

3D

**Customer View Model**[ENG_CVM_CVM_1-1376393-2_H_c-1-1376393-2-h.2d_dxf.zip](#)

English

Customer View Model[ENG_CVM_CVM_1-1376393-2_H_c-1-1376393-2-h.3d_igs.zip](#)

English

Customer View Model[ENG_CVM_CVM_1-1376393-2_H_c-1-1376393-2-h.3d_stp.zip](#)

English

By downloading the CAD file I accept and agree to the [Terms and Conditions](#) of use.

Datasheets & Catalog Pages[SOFT_SHELL_PIN_SOCKET_CONNECTORS_STANDARD_DENSITY](#)

English

[1-1773881-9 Power Key Connector Quick Reference Guide](#)

English

Product Specifications[5.0 POWER KEY CONNECTOR](#)

Japanese

[Application Specification](#)

Japanese

Product Environmental Compliance[MD_1-1376393-2_10302013111_dmtec](#)

English

[MD_1-1376393-2_10302013111_dmtec](#)

English

Instruction Sheets[The extraction tool for 5MM Power Key Contact](#)

English

[Instruction Sheet \(non U.S.\)](#)

English

Agency Approvals[VDE Certificate](#)

English