

1-770872-1 ✓ ACTIVE

MATE-N-LOK | Mini-Universal MATE-N-LOK

TE Internal #: 1-770872-1

Rectangular Power Connectors, Header, Receptacle, Wire-to-Board, 2 Position, .162 in [4.14 mm] Centerline, Mini-Universal MATE-N-LOK

[View on TE.com >](#)



Connectors > Power Connectors > Rectangular Power > Rectangular Power Connectors



Rectangular Power Connector Type: **Header**

Connector & Housing Type: **Receptacle**

Connector System: **Wire-to-Board**

Number of Positions: **2**

Centerline (Pitch): **4.14 mm [.162 in]**

Features

Product Type Features

Header Type	Fully Shrouded
Rectangular Power Connector Type	Header
Connector & Housing Type	Receptacle
Connector System	Wire-to-Board
Sealable	No
Connector & Contact Terminates To	Printed Circuit Board

Configuration Features

Number of Positions	2
PCB Mount Orientation	Vertical
Number of Power Positions	2
Number of Signal Positions	0
Number of Rows	1

Electrical Characteristics

Operating Voltage	600 VDC
-------------------	---------



Contact Features

Contact Layout	Inline
Multiple Contact Types	Without
Contact Current Rating (Max)	9.5 A
Contact Retention Within Housing	Without
Contact Type	Pin
PCB Contact Termination Area Plating Material	Tin-Lead
Contact Mating Area Plating Material	Gold
Contact Mating Area Plating Material Thickness	.76 μm [30 μin]
Contact Termination Area Plating Thickness	3.81 μm [150 μin]

Termination Features

Termination Post & Tail Length	3.69 mm[.145 in]
Termination Method to Printed Circuit Board	Through Hole - Solder

Mechanical Attachment

Strain Relief	Without
Mating Alignment Type	Chamfered Edges
Mating Alignment	With
PCB Mount Alignment	Without
Panel Mount Feature	Without
PCB Mount Retention	With
PCB Mount Retention Type	Boardlock
Connector Mounting Type	Board Mount
Mating Retention	With
Mating Retention Type	Locking Tab

Housing Features

Centerline (Pitch)	4.14 mm[.162 in]
Housing Color	White
Housing Material	Nylon, Nylon GF

Dimensions

Width	9.83 mm
PCB Thickness (Recommended)	.06 mm[1.57 in]
Height	13.49 mm



Length	9.83 mm
--------	---------

Usage Conditions

Operating Temperature Range	-55 – 105 °C[-67 – 221 °F]
-----------------------------	----------------------------

Operation/Application

Assembly Integration Feature	Without
------------------------------	---------

Circuit Application	Power
---------------------	-------

Industry Standards

CSA Rating	Certified
------------	-----------

UL Flammability Rating	UL 94V-0
------------------------	----------

Glow Wire Rating	Standard Part - Not Glow Wire
------------------	-------------------------------

Agency/Standard Number	E28476
------------------------	--------

Agency/Standard	CSA, UL
-----------------	---------

UL Rating	Recognized
-----------	------------

CSA File Number	LR7189
-----------------	--------

VDE Tested	No
------------	----

Packaging Features

Packaging Method	Bag
------------------	-----

Packaging Quantity	200
--------------------	-----

Other

For Use With	Plug Housing
--------------	--------------

Product Compliance

[For compliance documentation, visit the product page on TE.com>](#)

EU RoHS Directive 2011/65/EU	Compliant
------------------------------	-----------

EU ELV Directive 2000/53/EC	Compliant
-----------------------------	-----------

China RoHS 2 Directive MIIT Order No 32, 2016	No Restricted Materials Above Threshold
---	---

EU REACH Regulation (EC) No. 1907/2006	Current ECHA Candidate List: JAN 2022 (223) Candidate List Declared Against: JAN 2022 (223) Does not contain REACH SVHC
--	---

Halogen Content	Low Halogen - Br, Cl, F, I < 900 ppm per homogenous material. Also BFR/CFR/PVC Free
-----------------	---

Solder Process Capability

Wave solder capable to 265°C

Product Compliance Disclaimer

This information is provided based on reasonable inquiry of our suppliers and represents our current actual knowledge based on the information they provided. This information is subject to change. The part numbers that TE has identified as EU RoHS compliant have a maximum concentration of 0.1% by weight in homogenous materials for lead, hexavalent chromium, mercury, PBB, PBDE, DBP, BBP, DEHP, DIBP, and 0.01% for cadmium, or qualify for an exemption to these limits as defined in the Annexes of Directive 2011/65/EU (RoHS2). Finished electrical and electronic equipment products will be CE marked as required by Directive 2011/65/EU. Components may not be CE marked. Additionally, the part numbers that TE has identified as EU ELV compliant have a maximum concentration of 0.1% by weight in homogenous materials for lead, hexavalent chromium, and mercury, and 0.01% for cadmium, or qualify for an exemption to these limits as defined in the Annexes of Directive 2000/53/EC (ELV). Regarding the REACH Regulation, the information TE provides on SVHC in articles for this part number is based on the latest European Chemicals Agency (ECHA) 'Guidance on requirements for substances in articles' posted at this URL: <https://echa.europa.eu/guidance-documents/guidance-on-reach>

Compatible Parts



TE Part # 794894-1
02P MINI UMNL PLUGS WIRE HOLES



TE Part # 172165-1
2 CIR UNIV M-N-L PLUG NATL



TE Part # 794184-1
02P MINI UMNL2 PLUG HSG UL94V0



TE Part # 794772-2
02P MINI UMNL SEAL, DIE CUT

Also in the Series | Mini-Universal MATE-N-LOK

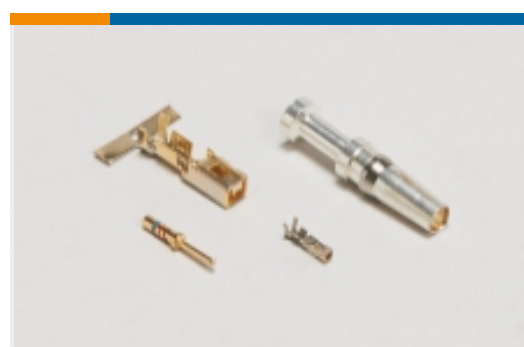

Connector Contacts(11)



Insertion & Extraction Tools(1)



PCB Headers & Receptacles(1)

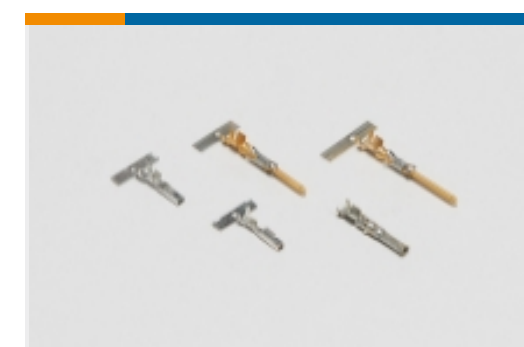

Power Contacts(85)



Rectangular Backshells & Clamps(2)



Rectangular Boots & Strain Relief(2)



Rectangular Connector Keying Plugs(2)



Rectangular Connector Locking(2)

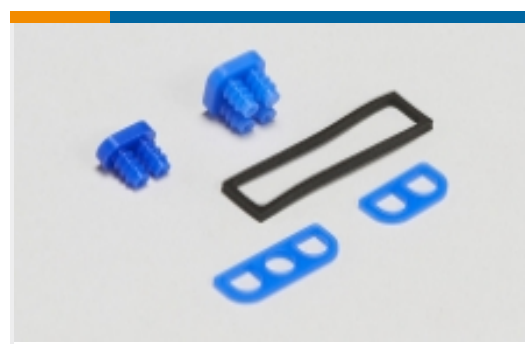

Rectangular Connector Seals(20)



Rectangular Power Connectors(283)

Customers Also Bought



TE Part #794880-1
09P UMNL PIN HDR ASSY 94VO



TE Part #794876-1
02P UMNL PIN HDR ASSY POL 94VO



TE Part #1-1879336-7
CPF 0603 340R 1% 50PPM 1K RL

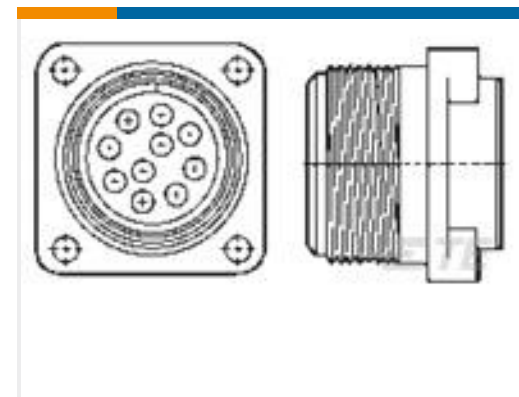

TE Part #213667-1
18-10 CPC SQ FLNG RCPT REV SEX



TE Part #1-794073-1
08P MINI UMNL HDR W/O DH AU LF

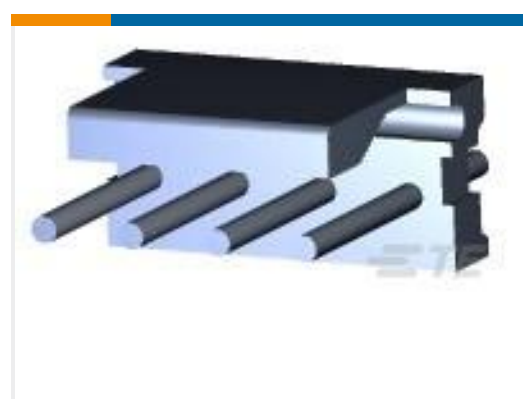

TE Part #3-641120-4
04P MTA156 HDR ASSY FL/ST LF



TE Part #1-66473-8
SKT,.062 DIA,.045 SQ POST,LP

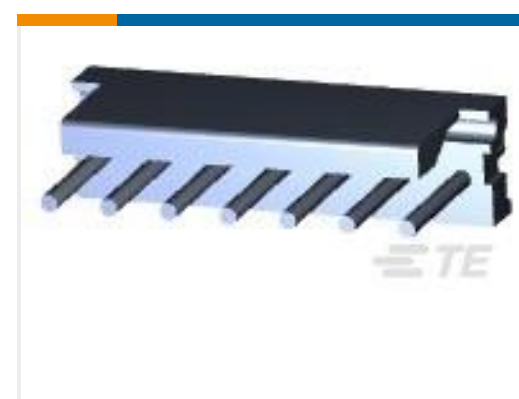

TE Part #3-641120-7
07P MTA156 HDR ASSY FL/ST LF

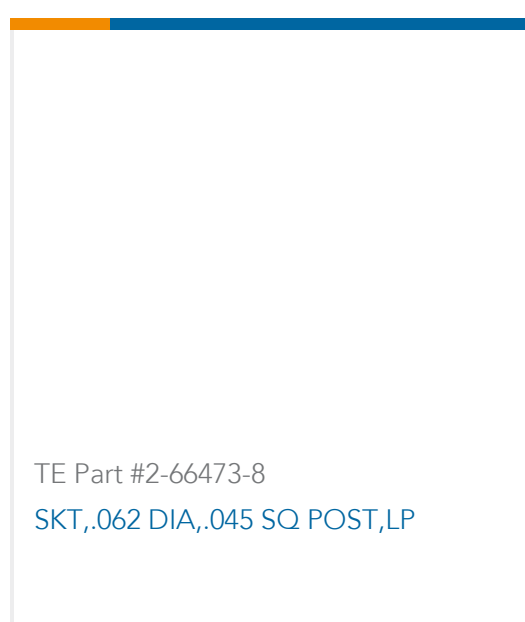

TE Part #2-66473-8
SKT,.062 DIA,.045 SQ POST,LP

Documents

Product Drawings

[02P MINI UMNL HDR ASSY AU LF](#)

English

CAD Files

[3D PDF](#)

3D

Customer View Model

[ENG_CVM_CVM_1-770872-1_H.2d_dxf.zip](#)



English

Customer View Model

[ENG_CVM_CVM_1-770872-1_H.3d_igs.zip](#)

English

Customer View Model

[ENG_CVM_CVM_1-770872-1_H.3d_stp.zip](#)

English

By downloading the CAD file I accept and agree to the [Terms and Conditions](#) of use.

Datasheets & Catalog Pages

[SOFT_SHELL_PIN_AND_SOCKET_CONNECTORS_CATALOG](#)

English

[1-1773458-0_MINI_UNIVERSAL_MATE_N_LOK_CONNECTOR_SYSTEM_QRG](#)

English

Product Specifications

[Application Specification](#)

English

Product Environmental Compliance

[MD_1-770872-1_11062017428_dmtec](#)

English

[MD_1-770872-1_11062017428_dmtec](#)

English

Instruction Sheets

[Instruction Sheet \(U.S.\)](#)

English

Agency Approvals

[UL](#)

English