

1-173977-5 ✓ ACTIVE



AMP CT

TE Internal #: 1-173977-5

Connector Assembly, Receptacle, Wire-to-Board, 15 Position, 2 mm [.079 in] Centerline, Insulation Displacement (IDC), 1 Row, Natural, AMP CT

[View on TE.com >](#)

Connectors > PCB Connectors > Wire-to-Board Connectors > Wire-to-Board Connector Assemblies & Housings >

AMP COMMON TERMINATION HOUSINGS

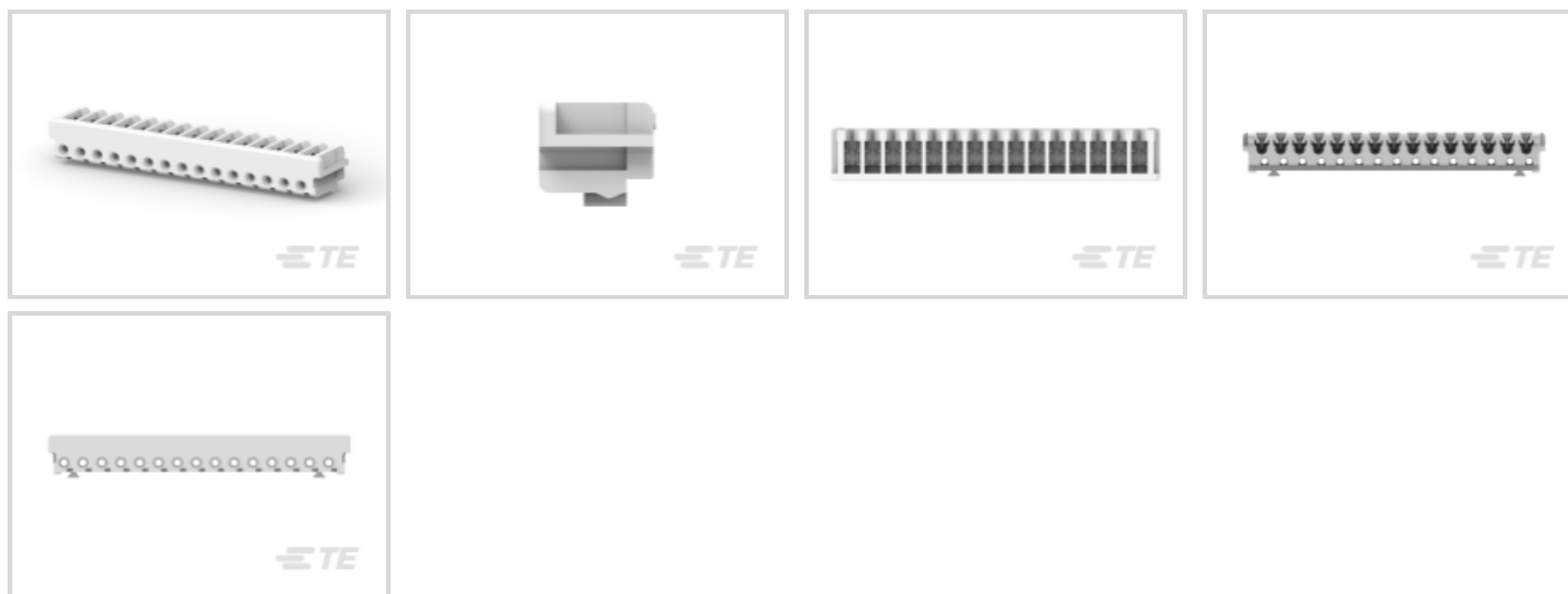

Connector Product Type: **Connector Assembly**

Connector & Housing Type: **Receptacle**

Connector System: **Wire-to-Board**

Number of Positions: **15**

Centerline (Pitch): **2 mm [.079 in]**

[All AMP COMMON TERMINATION HOUSINGS \(176\)](#)

Features

Product Type Features

Connector Product Type	Connector Assembly
Connector & Housing Type	Receptacle
Connector System	Wire-to-Board
Sealable	No
Connector & Contact Terminates To	Wire & Cable

Configuration Features

Number of Positions	15
Number of Rows	1

Contact Features

Contact Current Rating (Max)	2 A
------------------------------	-----

Termination Features



Termination Method to Wire & Cable	Insulation Displacement (IDC)
------------------------------------	-------------------------------

Mechanical Attachment

Mating Retention	Without
Connector Mounting Type	Cable Mount (Free-Hanging)

Housing Features

Housing Material	PBT GF
Centerline (Pitch)	2 mm [.079 in]
Housing Color	Natural

Usage Conditions

Operating Temperature Range	-30 – 105 °C [-22 – 221 °F]
-----------------------------	-----------------------------

Operation/Application

Circuit Application	Power & Signal
---------------------	----------------

Product Compliance

[For compliance documentation, visit the product page on TE.com>](#)

EU RoHS Directive 2011/65/EU	Compliant
EU ELV Directive 2000/53/EC	Compliant
China RoHS 2 Directive MIIT Order No 32, 2016	No Restricted Materials Above Threshold
EU REACH Regulation (EC) No. 1907/2006	Current ECHA Candidate List: JAN 2022 (223) Candidate List Declared Against: JAN 2022 (223) Does not contain REACH SVHC
Halogen Content	Not Low Halogen - contains Br or Cl > 900 ppm.
Solder Process Capability	Not applicable for solder process capability

Product Compliance Disclaimer

This information is provided based on reasonable inquiry of our suppliers and represents our current actual knowledge based on the information they provided. This information is subject to change. The part numbers that TE has identified as EU RoHS compliant have a maximum concentration of 0.1% by weight in homogenous materials for lead, hexavalent chromium, mercury, PBB, PBDE, DBP, BBP, DEHP, DIBP, and 0.01% for cadmium, or qualify for an exemption to these limits as defined in the Annexes of Directive 2011/65/EU (RoHS2). Finished electrical and electronic equipment products will be CE marked as required by Directive 2011/65/EU. Components may not be CE marked. Additionally, the part numbers that TE has identified as EU ELV compliant have a maximum concentration of 0.1% by weight in homogenous materials for lead, hexavalent chromium, and mercury, and 0.01% for cadmium, or qualify for an exemption to these limits as defined in the Annexes of Directive 2000/53/EC (ELV). Regarding the REACH Regulation, the information TE provides on SVHC in articles for this part number is based on the latest European Chemicals Agency (ECHA) 'Guidance on requirements for substances in articles' posted at this URL: <https://echa.europa.eu/guidance-documents/guidance-on-reach>

Compatible Parts



TE Part # 1-292161-5
CT P/HDR ASSY V 15P W/KINK NAT



TE Part # CAT-3983178-PHBXVD
CT 2mm Post Header Asmby: Box V DIP



TE Part # 1-292173-5
CT BOX HDR H SMT 5P O/TAPE NAT



TE Part # 58074-1
MTA 50/100/156 MANUAL TOOL FRAME



TE Part # 58372-1
HEAD (IDC) 2MM C.T. W/O TL



TE Part # 1-292254-5
CT RELAY HDR ASSY 15P NAT



TE Part # 3-175133-0
CT DOUBLE ROW 30P HOLDER NATU.



TE Part # 3-179608-0
CT DBL ROW HOLDER,MT,30P,NA



TE Part # CAT-3980407-RHDRRA
CT 2mm Header Assembly: Right Angle



TE Part # 1-292250-5
CT P/HDR BOX H ASSY 15P W/KINK



TE Part # 1-292133-5
CT P/HDR ASSY BOX V 15P W/O KI



TE Part # 1-292134-5
CT BOX HDR ASSY V 15P AU W/KIN



TE Part # 1-292130-5
CT P/HDR BOX-H 15P SHORT W/KIN



TE Part # 1-292145-5
CT P/HDR ASSY V 15P W/O KINK N



TE Part # 1-292164-5
CT P/HDR BOX H ASSY 15P T/P NA



TE Part # 1-292165-5
CT P/HDR BOX V 15P T/P NAT



TE Part # 1-292166-5
CT P/HDR BOX V 15P T/P NAT W/O



TE Part # 1-292170-5
CT P/HDR ASSY 15P V W/O KINK



TE Part # 1-292271-5
MT REC ASSY AU-PL. 15P GRAY



TE Part # 3-176233-0
CT DBL ROW HOLDER 30P BLACK

Also in the Series | **AMP CT**



PCB Connector Mounting(46)

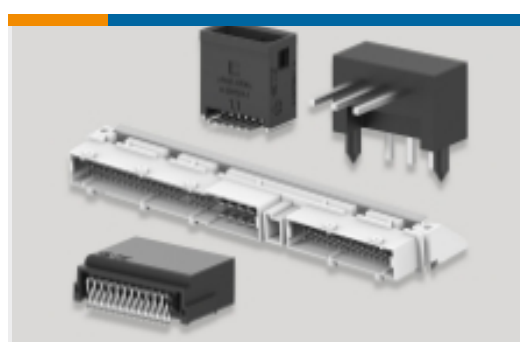

PCB Headers & Receptacles(756)

Wire-to-Board Connector Assemblies
& Housings(257)

Wire-to-Board Connector Contacts(8)

Customers Also Bought

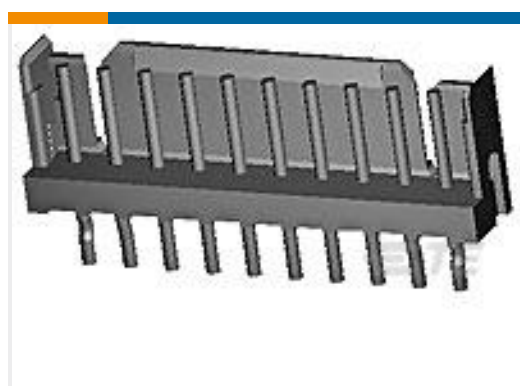
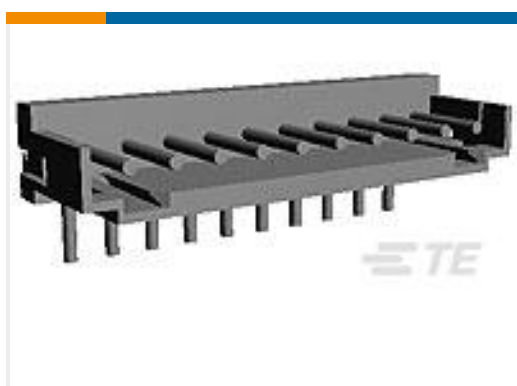
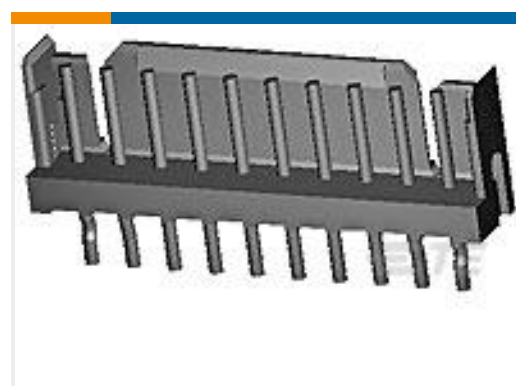
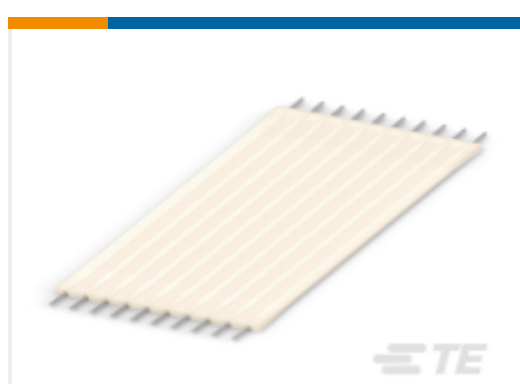
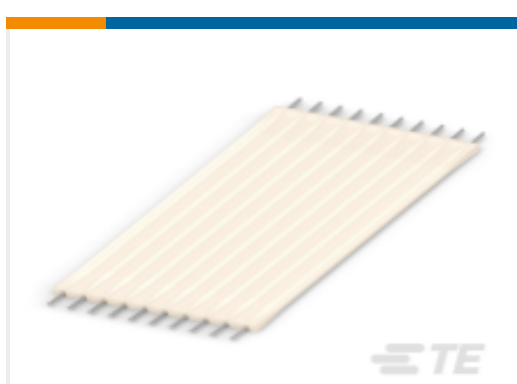
TE Part #173977-9
AMP COMMON TERMINATION
HOUSINGSTE Part #292161-8
CT P/HDR ASSY V 8P W/KINK NATTE Part #292253-8
CT CONN MT HDR ASSY H 8P NATTE Part #292161-9
CT P/HDR ASSY V 9P W/KINK NATTE Part #292172-8
CT POST HDR ASSY 8P IN-TUBE BLTE Part #1-6437158-6
FSN-11ATE Part #4-6474612-4
FSN-11A-7

Documents

CAD Files

Customer View Model

[ENG_CVM_CVM_1-173977-5_M.2d_dxf.zip](#)

English

3D PDF

3D

Customer View Model

[ENG_CVM_CVM_1-173977-5_M.3d_igs.zip](#)

English

Customer View Model

[ENG_CVM_CVM_1-173977-5_M.3d_stp.zip](#)

English

By downloading the CAD file I accept and agree to the [Terms and Conditions](#) of use.

Datasheets & Catalog Pages

[POWER_CONNECTORS_CATALOG_SEC02_CABLE_MOUNTED](#)

English



[2.0MM_AMP_CT_CONNECTOR_SERIES_QUICK_REF_GUIDE](#)

English

[Product Specifications](#)

[Application Specification](#)

English

[Product Environmental Compliance](#)

[MD_1-173977-5_04102015222_dmtec](#)

English

[MD_1-173977-5_04102015222_dmtec](#)

English

[Instruction Sheets](#)

[MINI PRESS CT CONNECTOR \(WAS IS-553J\)](#)

Japanese

[Instruction Sheet \(non U.S.\)](#)

Japanese

[Agency Approvals](#)

[CSA Certificate](#)

English