

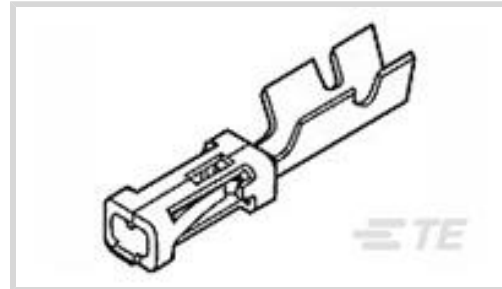

Connectors > PCB Connectors > Wire-to-Board Connectors > Wire-to-Board Connector Contacts



Contact Type: **Socket**

Connector System: **Wire-to-Board**

Wire Size: **.2 – .6 mm²**

Features

Product Type Features

Applied Pressure	Standard
Connector System	Wire-to-Board
Connector & Contact Terminates To	Wire & Cable

Configuration Features

Compatible With Wire & Cable Type	Discrete Wire
-----------------------------------	---------------

Electrical Characteristics

Termination Resistance	12 mΩ
Insulation Resistance	5000 MΩ
Dielectric Withstanding Voltage (Max)	750 V
Operating Voltage	250 VAC

Contact Features

Mating Square Post Dimension	.64 mm[.025 in]
	15 μin
Wire Contact Termination Area Plating Material	Tin-Lead, Tin-Lead over Nickel
Contact Base Material	Copper Tin Phosphor Bronze
Contact Type	Socket
Contact Mating Area Plating Material	Gold
Contact Current Rating (Max)	3 A

Termination Features

--	--



Termination Method to Wire & Cable	Crimp
------------------------------------	-------

Mechanical Attachment

Wire Insulation Support	With
-------------------------	------

Dimensions

Accepts Wire Insulation Diameter Range	1.75 mm [.069 in]
--	-------------------

Wire Size	.2 – .6 mm ²
-----------	-------------------------

Usage Conditions

Operating Temperature Range	-65 – 105 °C [-85 – 221 °F]
-----------------------------	-----------------------------

Operation/Application

Circuit Application	Power & Signal
---------------------	----------------

Industry Standards

Approved Standards	CSA LR7189, UL E28476
--------------------	-----------------------

Packaging Features

Packaging Quantity	1000
--------------------	------

Packaging Method	Loose Piece
------------------	-------------

Other

Comment	(*) For use with Model "K" machines. Call the Technical Assistance Center (1-800-522-6752) for any tooling questions.
---------	---

Product Compliance

[For compliance documentation, visit the product page on TE.com>](#)

EU RoHS Directive 2011/65/EU	Not Compliant
------------------------------	---------------

EU ELV Directive 2000/53/EC	Not Compliant
-----------------------------	---------------

China RoHS 2 Directive MIIT Order No 32, 2016	Restricted Materials Above Threshold
---	--------------------------------------

EU REACH Regulation (EC) No. 1907/2006	Current ECHA Candidate List: JAN 2022 (223) Candidate List Declared Against: JAN 2022 (223) SVHC > Threshold: Pb (13% in Component Part)
--	---

Article Safe Usage Statements:
Do not eat, drink or smoke when using this product. Wash thoroughly after handling. Recycle if possible and dispose of the article by following all applicable governmental regulations relevant to your geographic location.

Halogen Content	Low Halogen - Br, Cl, F, I < 900 ppm per homogenous material. Also BFR/CFR/PVC Free
-----------------	---

Solder Process Capability

Not applicable for solder process capability

Product Compliance Disclaimer

This information is provided based on reasonable inquiry of our suppliers and represents our current actual knowledge based on the information they provided. This information is subject to change. The part numbers that TE has identified as EU RoHS compliant have a maximum concentration of 0.1% by weight in homogenous materials for lead, hexavalent chromium, mercury, PBB, PBDE, DBP, BBP, DEHP, DIBP, and 0.01% for cadmium, or qualify for an exemption to these limits as defined in the Annexes of Directive 2011/65/EU (RoHS2). Finished electrical and electronic equipment products will be CE marked as required by Directive 2011/65/EU. Components may not be CE marked. Additionally, the part numbers that TE has identified as EU ELV compliant have a maximum concentration of 0.1% by weight in homogenous materials for lead, hexavalent chromium, and mercury, and 0.01% for cadmium, or qualify for an exemption to these limits as defined in the Annexes of Directive 2000/53/EC (ELV). Regarding the REACH Regulation, the information TE provides on SVHC in articles for this part number is based on the latest European Chemicals Agency (ECHA) 'Guidance on requirements for substances in articles' posted at this URL: <https://echa.europa.eu/guidance-documents/guidance-on-reach>

Compatible Parts



TE Part # 91516-1
CCII MOD IV REC 30-20 ASSY



TE Part # 87499-7
04 MODIV HSG SR MRKD .100CL



TE Part # 87499-4
02 MODIV HSG COMP SR .100CL



TE Part # 87499-3
02 MODIV HSG SR MRKD .100CL



TE Part # 2-87499-1
12 MODIV HSG SR MRKD .100CL



TE Part # 843996-3
TOOL, EXTRACTION RESET



TE Part # 91516-3
CCII MOD IV REC 30-20 HEAD

Also in the Series | AMPMODU IV/V

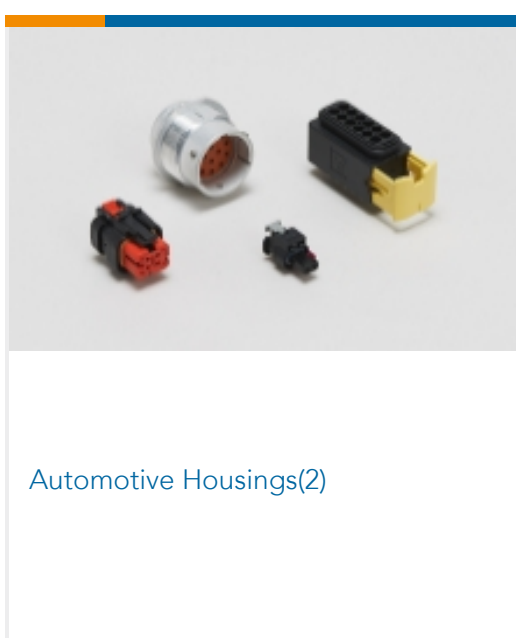

Automotive Housings(2)

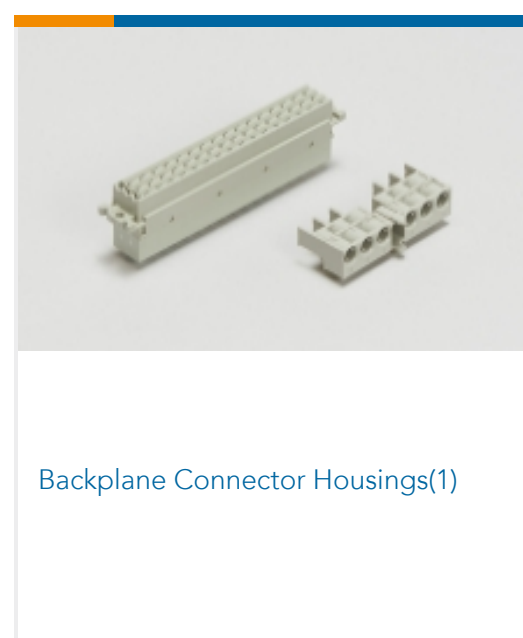

Backplane Connector Housings(1)

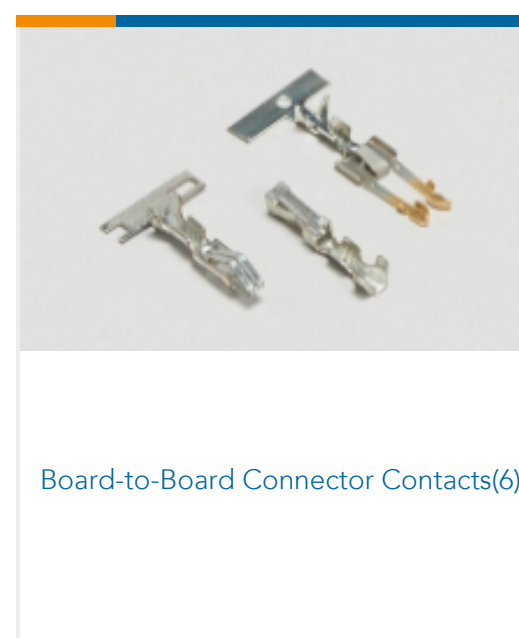

Board-to-Board Connector Contacts(6)

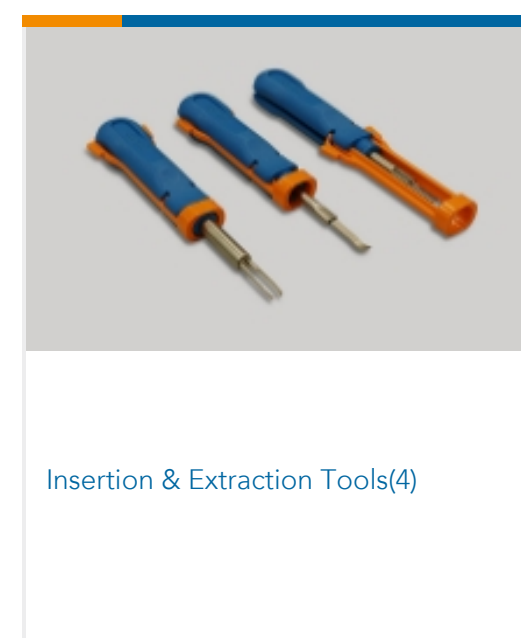

Insertion & Extraction Tools(4)

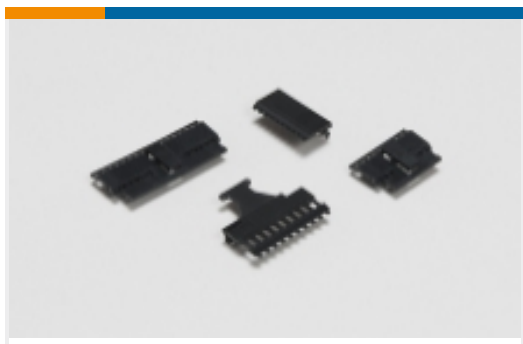

PCB Connector Covers(18)



PCB Connector Keying(6)



PCB Connector Mounting(1)

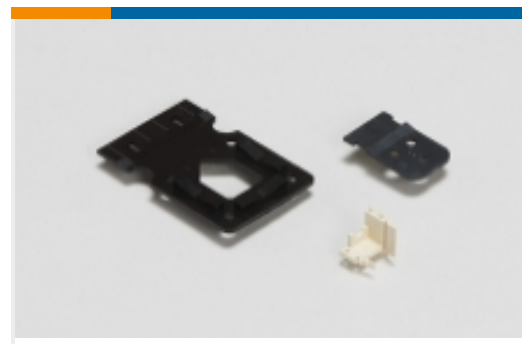

PCB Connector Strain Relief(3)

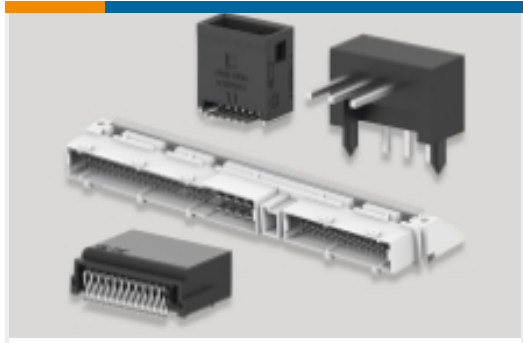

PCB Headers & Receptacles(939)

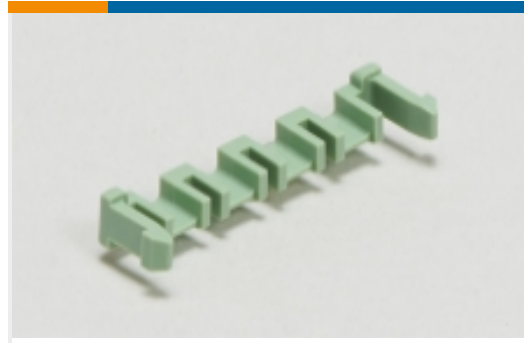

PCB Latches, Locks & Retainers(9)



Rectangular Connector Housings(5)



Standard Rectangular Connectors(8)



Wire-to-Board Connector Assemblies & Housings(473)



Wire-to-Board Connector Contacts (328)

Customers Also Bought



TE Part #60433-2
RING CRIMP 18-14 AWG TPBR

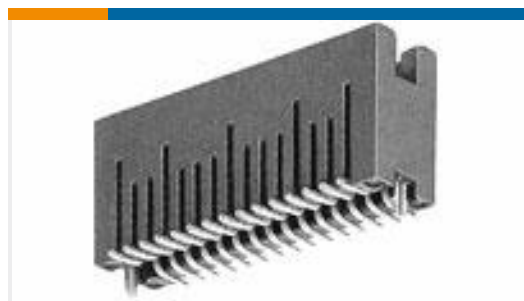

TE Part #5-104693-3
30 50/50 HDR DRST SFMNT.390 SN



TE Part #324052
TERMINAL,T-N R 4 3/8



TE Part #324051
TERMINAL,T-N R 4 5/16



TE Part #87631-1
06 MODIV HSG COMP DR .100 POL

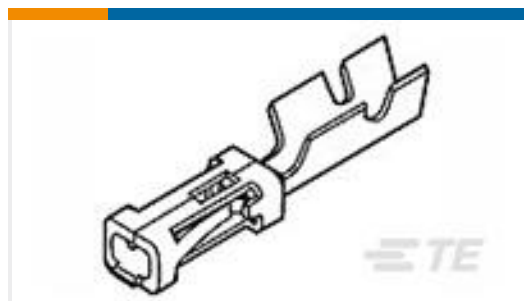

TE Part #1-102316-3
MOD IV RECP LP



TE Part #1887112-2
XT374L24

Documents



Product Drawings

MOD IV RECP LP

English

CAD Files

3D PDF

3D

Customer View Model

[ENG_CVM_CVM_1-87523-6_AJ.2d_dxf.zip](#)

English

Customer View Model

[ENG_CVM_CVM_1-87523-6_AJ.3d_igs.zip](#)

English

Customer View Model

[ENG_CVM_CVM_1-87523-6_AJ.3d_stp.zip](#)

English

By downloading the CAD file I accept and agree to the [Terms and Conditions](#) of use.

Product Specifications

Application Specification

English

Product Environmental Compliance

[MD_1-87523-6_11162015023_dmtec](#)

English

[MD_1-87523-6_11162015023_dmtec](#)

English