



Connectors > PCB Connectors > Wire-to-Board Connectors > Wire-to-Board Connector Assemblies & Housings



Connector Product Type: **Housing**

Connector & Housing Type: **Receptacle**

Connector System: **Wire-to-Board**

Number of Positions: **4**

Centerline (Pitch): **2.54 mm [.1 in]**

## Features

### Product Type Features

Connector Product Type	Housing
Connector & Housing Type	Receptacle
Connector System	Wire-to-Board
Connector & Contact Terminates To	Wire & Cable

### Configuration Features

Number of Positions	4
Number of Rows	1

### Electrical Characteristics

Termination Resistance	12 mΩ
Insulation Resistance	5000 MΩ
Dielectric Withstanding Voltage (Max)	750 V
Operating Voltage	250 VAC

### Contact Features

Contact Layout	Inline
Contact Type	Socket
Contact Base Material	Phosphor Bronze
Contact Current Rating (Max)	3 A

### Termination Features



Termination Method to Wire & Cable	Crimp
------------------------------------	-------

### Mechanical Attachment

Mating Retention Type	Lock
Mating Retention	Without

### Housing Features

Housing Entry Configuration	Both Ends Closed
Housing Material	Polyester GF
Centerline (Pitch)	2.54 mm [.1 in]
Housing Color	Black

### Dimensions

Connector Length	10.56 mm [.42 in]
Connector Height	4.44 mm [.175 in]

### Usage Conditions

Operating Temperature Range	-65 – 105 °C [-85 – 221 °F]
-----------------------------	-----------------------------

### Operation/Application

Circuit Application	Power & Signal
---------------------	----------------

### Industry Standards

Glow Wire Rating	Standard Part - Not Glow Wire
Approved Standards	CSA LR7189, UL E28476
UL Flammability Rating	UL 94V-0

### Packaging Features

Packaging Quantity	1
Packaging Method	Package

### Product Compliance

[For compliance documentation, visit the product page on TE.com>](#)

EU RoHS Directive 2011/65/EU	Compliant
EU ELV Directive 2000/53/EC	Compliant
China RoHS 2 Directive MIIT Order No 32, 2016	No Restricted Materials Above Threshold
EU REACH Regulation (EC) No. 1907/2006	Current ECHA Candidate List: JAN 2022 (223) Candidate List Declared Against: JAN 2022 (223)

Does not contain REACH SVHC

Halogen Content

Not Low Halogen - contains Br or Cl > 900 ppm.

Solder Process Capability

Not applicable for solder process capability

Product Compliance Disclaimer

This information is provided based on reasonable inquiry of our suppliers and represents our current actual knowledge based on the information they provided. This information is subject to change. The part numbers that TE has identified as EU RoHS compliant have a maximum concentration of 0.1% by weight in homogenous materials for lead, hexavalent chromium, mercury, PBB, PBDE, DBP, BBP, DEHP, DIBP, and 0.01% for cadmium, or qualify for an exemption to these limits as defined in the Annexes of Directive 2011/65/EU (RoHS2). Finished electrical and electronic equipment products will be CE marked as required by Directive 2011/65/EU. Components may not be CE marked. Additionally, the part numbers that TE has identified as EU ELV compliant have a maximum concentration of 0.1% by weight in homogenous materials for lead, hexavalent chromium, and mercury, and 0.01% for cadmium, or qualify for an exemption to these limits as defined in the Annexes of Directive 2000/53/EC (ELV). Regarding the REACH Regulation, the information TE provides on SVHC in articles for this part number is based on the latest European Chemicals Agency (ECHA) 'Guidance on requirements for substances in articles' posted at this URL: <https://echa.europa.eu/guidance-documents/guidance-on-reach>

## Compatible Parts

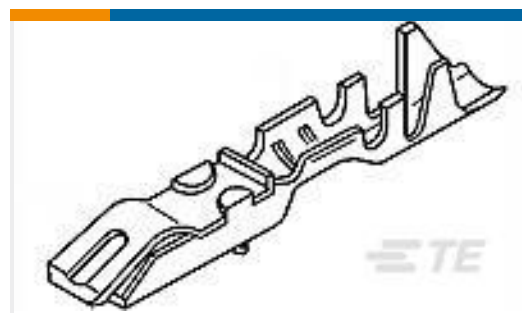

TE Part # 5-87165-2  
LOCKING CLIP ASSY .025 SQ LP

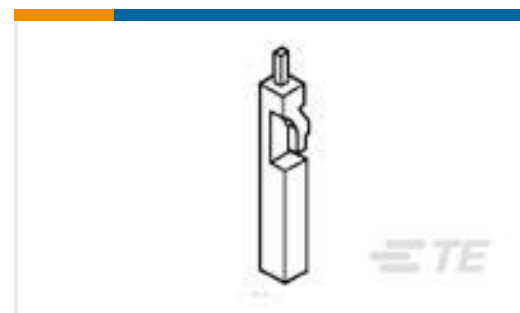

TE Part # 87179-1  
LOCKING CLIP KEYING PLUG

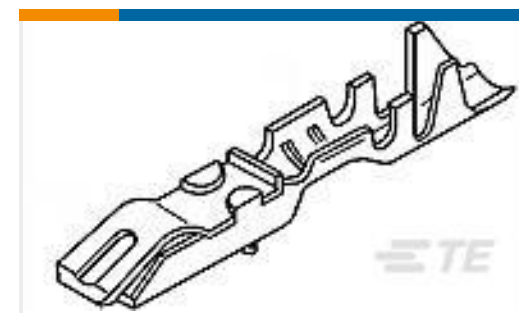

TE Part # 87190-1  
LOCKING CLIP CONT ASSY .025 SQ

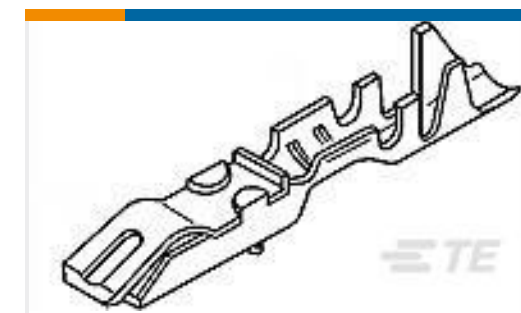

TE Part # 867052-2  
LOCKING CLIP CONT ASSY .025 SQ

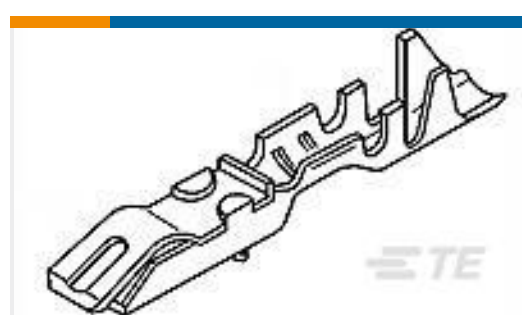

TE Part # 5-87124-2  
LOCKING CLIP CONT ASY .025 SQ

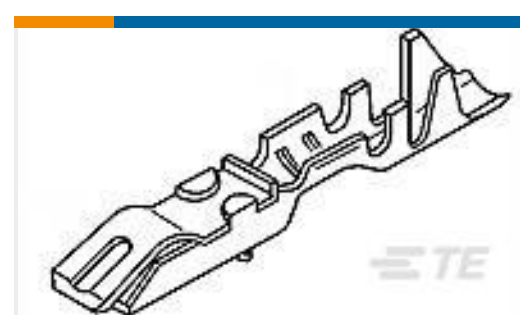

TE Part # 87124-1  
LOCKING CLIP CONT ASSY .025 SQ

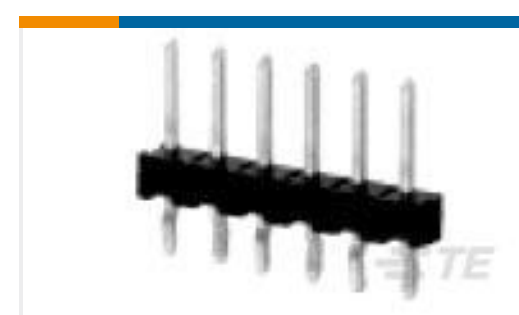

TE Part # 104346-2  
04 MODII HDR SRST B/A W/HD



TE Part # 5-146276-4  
04 MODII HDR SRST B/A .100CL



TE Part # 5-146280-4  
04 MODII HDR SRST B/A .100CL

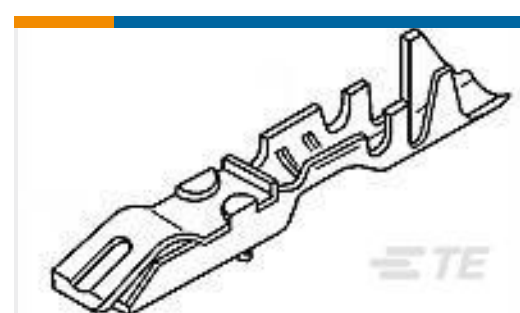

TE Part # 5-87191-2  
LOCKING CLIP ASSY .025 SQ LP

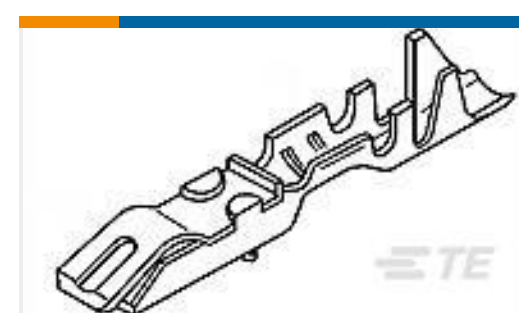

TE Part # 867052-1  
LOCKING CLIP CONT ASSY .025 SQ

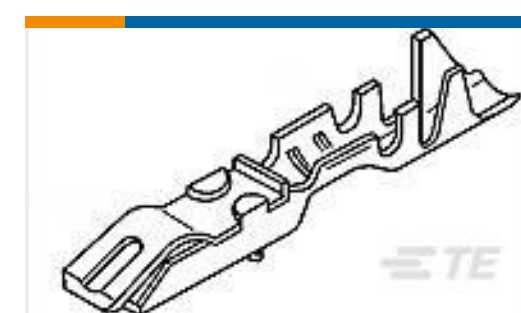

TE Part # 87165-2  
LOCKING CLIP ASSY .025 SQ LP



TE Part # 5-103327-1  
04 MODII HDR SRST B/A .100CL



TE Part # 104345-2  
04 MODII HDR SRST B/A W/HD



TE Part # 104426-2  
04 MODII HDR SRST B/A W/HD



TE Part # 5-102974-4  
04 MODII HD SRRA B/A .100CL,LF

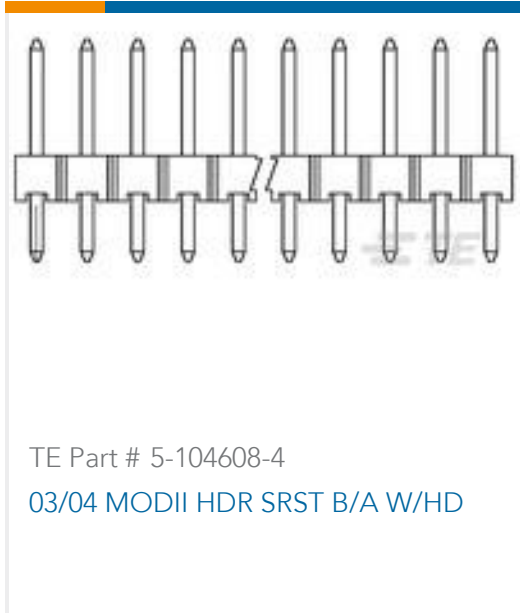

TE Part # 5-104608-4  
03/04 MODII HDR SRST B/A W/HD



TE Part # 5-147118-3  
04 MODII HDR SR SFMNT B/A LF



TE Part # 91084-1  
EXTRACTION TOOL



TE Part # 5-867052-1  
LOCKING CLIP CONT ASSY .025 SQ

Also in the Series | AMPMODU LOCKING CLIP

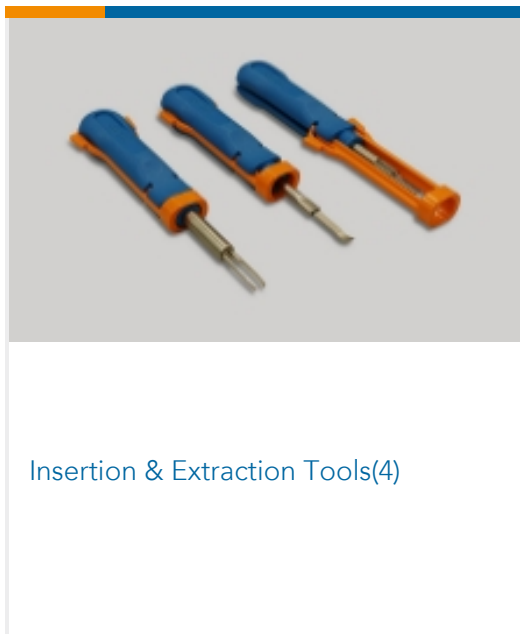

Insertion & Extraction Tools(4)



PCB Connector Keying(1)

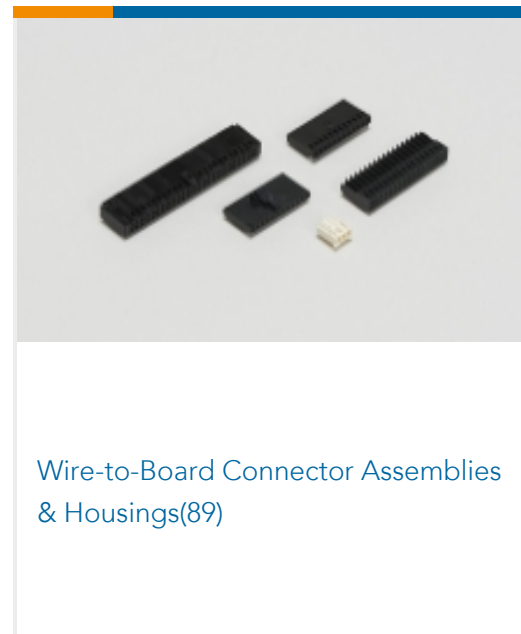

Wire-to-Board Connector Assemblies & Housings(89)

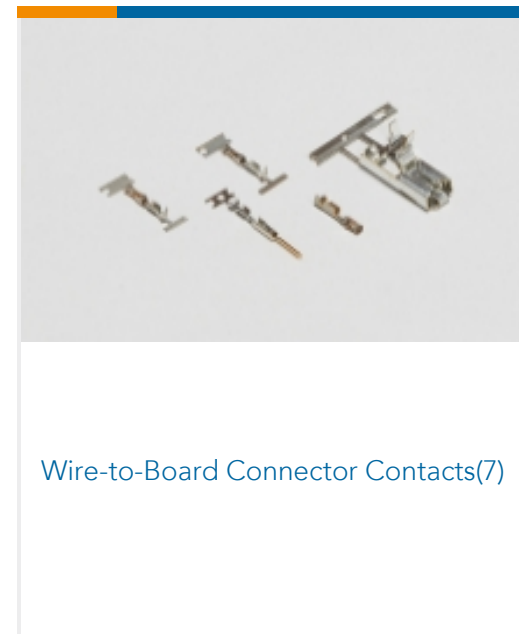

Wire-to-Board Connector Contacts(7)

Customers Also Bought



TE Part #3-641191-6  
06P MTA100 CONN ASSY WHT LF



TE Part #1-87631-2  
16 MODIV HSG DR MRKD .100 POL



TE Part #6-534998-3  
26 MODIV VRT DR CE 100/125



TE Part #3-1437622-0  
KN1251B1/4=KNOB BLK KNURL L/HA

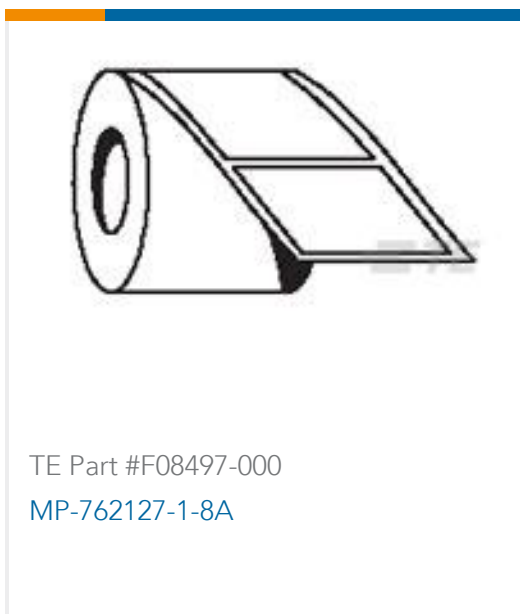

TE Part #F08497-000  
MP-762127-1-8A



TE Part #1-1658624-0  
050 NOVO DUAL 30DP FT



TE Part #NB19234001  
RNF-100-1/8-CL-SP

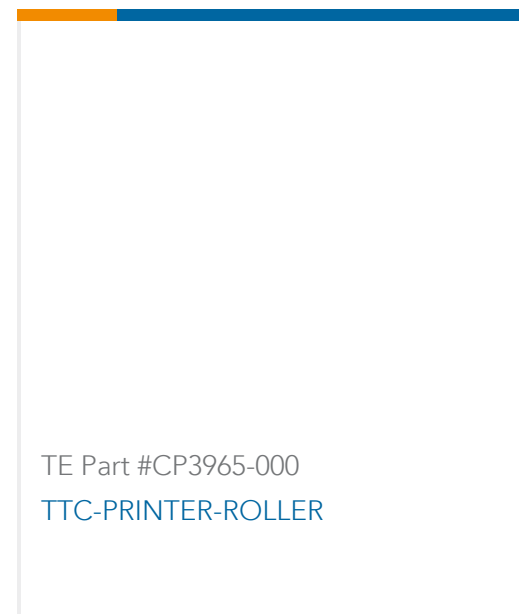

TE Part #CP3965-000  
TTC-PRINTER-ROLLER





## Documents

### Product Drawings

[04 LOCKING CLIP HSG SR .100CL](#)

English

### CAD Files

[3D PDF](#)

English

**Customer View Model**

[ENG\\_CVM\\_1-87175-0\\_U.3d\\_igs.zip](#)

English

**Customer View Model**

[ENG\\_CVM\\_1-87175-0\\_U.3d\\_stp.zip](#)

English

**Customer View Model**

[ENG\\_CVM\\_1-87175-0\\_U.2d\\_dxf.zip](#)

English

By downloading the CAD file I accept and agree to the [Terms and Conditions](#) of use.

### Datasheets & Catalog Pages

[AMPMODU\\_INTERCONNECTION\\_SYSTEM\\_SECTION5\\_CONT](#)

English

### Product Specifications

[Application Specification](#)

English

### Product Environmental Compliance

[MD\\_1-87175-0\\_10282015625\\_dmtec](#)

English

[MD\\_1-87175-0\\_10282015625\\_dmtec](#)

English

### Instruction Sheets

[Instruction Sheet \(U.S.\)](#)

English

[AMPMODU Locking Clip Contacts and Housings for 0.64mm Square Posts](#)

1-87175-0

Housing, Receptacle, Wire-to-Board, 4 Position, 2.54 mm [.1 in] Centerline, Crimp, 1 Row, Black, Wire & Cable, Power & Signal, AMPMODU LOCKING CLIP



English