

1-480345-0 ✓ ACTIVE

MATE-N-LOK | Commercial MATE-N-LOK

TE Internal #: 1-480345-0

Rectangular Power Connectors, Housing, Receptacle, Wire-to-Wire,
8 Position, .195 in [4.95 mm] Centerline, Wire & Cable, Commercial
MATE-N-LOK

[View on TE.com >](#)



Connectors > Power Connectors > Rectangular Power > Rectangular Power Connectors



Rectangular Power Connector Type: **Housing**

Connector & Housing Type: **Receptacle**

Connector System: **Wire-to-Wire**

Number of Positions: **8**

Centerline (Pitch): **4.95 mm [.195 in]**

Features

Product Type Features

Rectangular Power Connector Type	Housing
Connector & Housing Type	Receptacle
Connector System	Wire-to-Wire
Sealable	No
Connector & Contact Terminates To	Wire & Cable

Configuration Features

Number of Positions	8
Number of Rows	2

Electrical Characteristics

Operating Voltage	250 VAC
-------------------	---------

Contact Features

Contact Retention Within Housing	Without
Contact Type	Pin



Termination Features

Termination Method to Wire & Cable	Crimp
------------------------------------	-------

Mechanical Attachment

Panel Mount Feature	Without
Connector Mounting Type	Cable Mount (Free-Hanging)

Housing Features

Centerline (Pitch)	4.95 mm [.195 in]
Housing Color	Natural
Housing Material	Nylon

Dimensions

Row-to-Row Spacing	9.14 mm [.36 in]
--------------------	------------------

Usage Conditions

Operating Temperature Range	-55 – 105 °C [-67 – 221 °F]
-----------------------------	-----------------------------

Operation/Application

Circuit Application	Power & Signal
---------------------	----------------

Identification Marking

Circuit Identification Feature	With
--------------------------------	------

Industry Standards

UL Flammability Rating	UL 94V-2
Glow Wire Rating	Standard Part - Not Glow Wire
UL Rating	Certified, Recognized
Agency/Standard Number	E28476
CSA File Number	LR16455
VDE Tested	No
Agency/Standard	CSA, UL

Packaging Features

Packaging Method	Package
Packaging Quantity	1

Other

For Use With	Socket (Plug) Housing
--------------	-----------------------



Product Compliance

[For compliance documentation, visit the product page on TE.com>](#)

EU RoHS Directive 2011/65/EU	Compliant
EU ELV Directive 2000/53/EC	Compliant
China RoHS 2 Directive MIIT Order No 32, 2016	No Restricted Materials Above Threshold
EU REACH Regulation (EC) No. 1907/2006	Current ECHA Candidate List: JAN 2022 (223) Candidate List Declared Against: JAN 2022 (223) Does not contain REACH SVHC
Halogen Content	Low Halogen - Br, Cl, F, I < 900 ppm per homogenous material. Also BFR/CFR/PVC Free
Solder Process Capability	Not applicable for solder process capability













Product Compliance Disclaimer

This information is provided based on reasonable inquiry of our suppliers and represents our current actual knowledge based on the information they provided. This information is subject to change. The part numbers that TE has identified as EU RoHS compliant have a maximum concentration of 0.1% by weight in homogenous materials for lead, hexavalent chromium, mercury, PBB, PBDE, DBP, BBP, DEHP, DIBP, and 0.01% for cadmium, or qualify for an exemption to these limits as defined in the Annexes of Directive 2011/65/EU (RoHS2). Finished electrical and electronic equipment products will be CE marked as required by Directive 2011/65/EU. Components may not be CE marked. Additionally, the part numbers that TE has identified as EU ELV compliant have a maximum concentration of 0.1% by weight in homogenous materials for lead, hexavalent chromium, and mercury, and 0.01% for cadmium, or qualify for an exemption to these limits as defined in the Annexes of Directive 2000/53/EC (ELV). Regarding the REACH Regulation, the information TE provides on SVHC in articles for this part number is based on the latest European Chemicals Agency (ECHA) 'Guidance on requirements for substances in articles' posted at this URL: <https://echa.europa.eu/guidance-documents/guidance-on-reach>

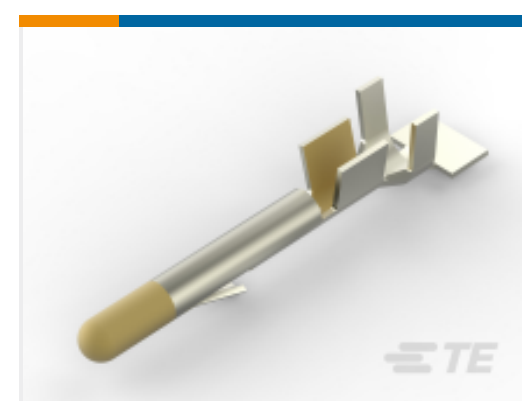

Compatible Parts

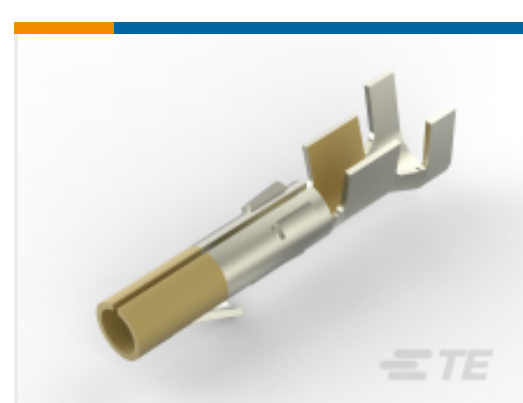
 <p>TE Part # 60619-5 CMNL SOK AUBR L/P</p>	 <p>TE Part # 60617-5 CMNL SOK AUBR L/P</p>	 <p>TE Part # 60618-5 CMNL PIN AUBR L/P</p>	 <p>TE Part # 60617-4 CMNL SOK PTPPHBZ L/P</p>
--	---	--	---

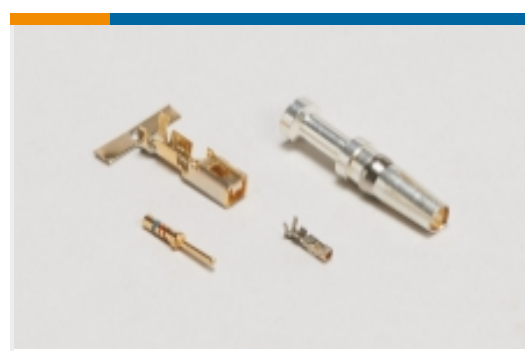

 <p>TE Part # 61174-1 CMNL PIN L/P PTBR</p>	 <p>TE Part # 61173-1 CMNL SOK 30-22 PTBR L/P</p>	 <p>TE Part # 60619-1 CMNL SOK PTPBR L/P</p>	 <p>TE Part # 60620-1 CMNL PIN 20-14 TPBR L/P</p>
 <p>TE Part # 60617-1 CMNL SOK SNBR L/P</p>	 <p>TE Part # 1-480283-0 08P CMNL PLUG HSG M/M NATL</p>	 <p>TE Part # 60620-4 CMNL PIN 20-14 TPPHBZ L/P</p>	 <p>TE Part # 163304-2 MATENLOK SOCKET SDW</p>
 <p>TE Part # 163305-2 MATENLOK PIN SDW</p>	 <p>TE Part # 60619-4 CMNL SOK PTPPHBZ L/P</p>	 <p>TE Part # 61118-5 CMNL PIN 20-14 AUNIBR</p>	 <p>TE Part # 61314-6 CMNL SOK S/F 24-18 .0125AUPHBZ</p>
 <p>TE Part # 61116-4 CMNL PIN 24-18 PTPHBZ</p>	 <p>TE Part # 61117-5 CMNL SOK 20-14 AUBR</p>	 <p>TE Part # 350557-4 MNL SOK SPECIAL .0125PTPHBZ</p>	 <p>TE Part # 61314-4 CMNL SOK 24-18 TPPHBZ</p>

Also in the Series | Commercial MATE-N-LOK

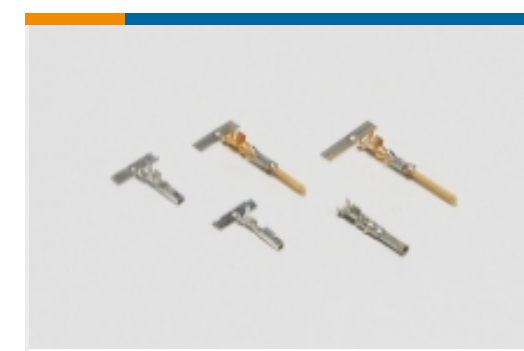
 <p>Connector Contacts(26)</p>	 <p>Crimp Wire Pins, Tabs & Ferrules(3)</p>	 <p>Insertion & Extraction Tools(5)</p>	 <p>Power Contacts(129)</p>
---	---	--	--



Rectangular Caps & Covers(2)



Rectangular Connector Housings(17)

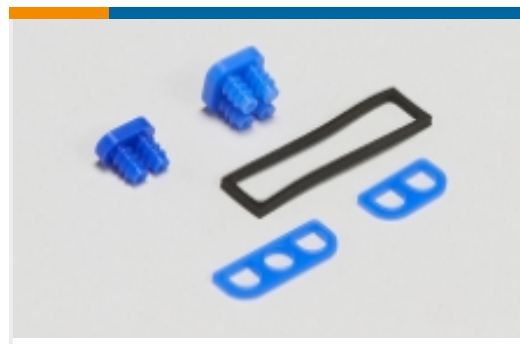

Rectangular Connector Seals(1)



Rectangular Power Connectors(170)



Standard Circular Connectors(4)



Standard Rectangular Connectors(10)



Wire-to-Board Connector Contacts(1)

Customers Also Bought



TE Part #1-480438-0
16P CMNL PLUG HSG M/M NATL



TE Part #1-480285-0
10P CMNL PLUG HSG M/M NATL



TE Part #1-480439-0
16P CMNL CAP HSG M/M NATL



TE Part #60620-1
CMNL PIN 20-14 TPBR L/P



TE Part #1-480270-0
06P CMNL PLUG HSG M/M NATL



TE Part #1-480305-0
03P CMNL CAP HSG F/H NATL



TE Part #1-480303-0
03P CMNL PLUG HSG F/H NATL

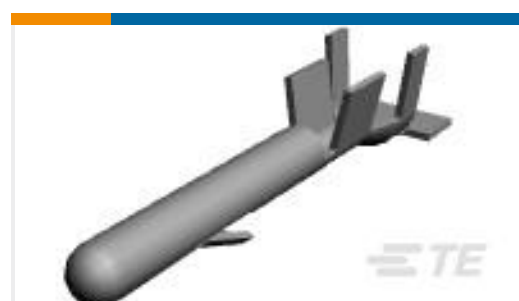

TE Part #61118-1
MNL PIN 20-14 TPBR

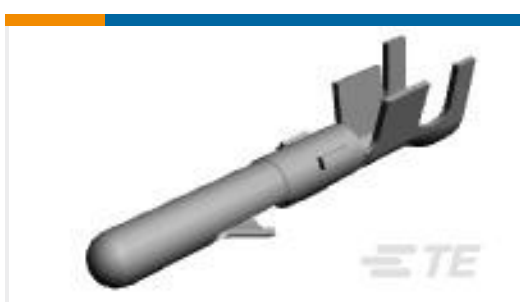

TE Part #60618-1
CMNL PIN PTPBR L/P



TE Part #1-1904045-5
V23333Z1001B045-EV-100

Documents



Product Drawings

08P CMNL CAP HSG F/H NATL

English

CAD Files

Customer View Model

[ENG_CVM_1-480345-0_H1.3d_igs.zip](#)

English

Customer View Model

[ENG_CVM_1-480345-0_H1.3d_stp.zip](#)

English

Customer View Model

[ENG_CVM_1-480345-0_H1.2d_dxf.zip](#)

English

3D PDF

English

3D PDF

3D

Customer View Model

[ENG_CVM_CVM_1-480345-0_AA.2d_dxf.zip](#)

English

Customer View Model

[ENG_CVM_CVM_1-480345-0_AA.3d_igs.zip](#)

English

Customer View Model

[ENG_CVM_CVM_1-480345-0_AA.3d_stp.zip](#)

English

By downloading the CAD file I accept and agree to the [Terms and Conditions](#) of use.

Datasheets & Catalog Pages

SOFT_SHELL_PIN_SOCKET_CONNECTORS_STANDARD_DENSITY

English

Product Specifications

Application Specification

English

Instruction Sheets

Instruction Sheet (U.S.)

Japanese

Instruction Sheet (U.S.)

English

Instruction Sheet (U.S.)

English

Instruction Sheet (U.S.)

English



[Agency Approvals](#)

[Agency Approval Document](#)

English