

1-215083-0 ✓ ACTIVE

Micro-MaTch Industrial

TE Internal #: 1-215083-0

TE Internal Description: MICRO-MATCH MOW.10P

MALE-ON-WIRE CONNECTOR

[View on TE.com >](#)



All MALE-ON-WIRE CONNECTOR (18)

Product Compliance

[For compliance documentation, visit the product page on TE.com>](#)

EU RoHS Directive 2011/65/EU	Compliant
EU ELV Directive 2000/53/EC	Compliant
China RoHS 2 Directive MIIT Order No 32, 2016	No Restricted Materials Above Threshold
EU REACH Regulation (EC) No. 1907/2006	Current ECHA Candidate List: JAN 2022 (223) Candidate List Declared Against: JAN 2022 (223) Does not contain REACH SVHC
Halogen Content	Not Low Halogen - contains Br or Cl > 900 ppm.
Solder Process Capability	Not applicable for solder process capability

Product Compliance Disclaimer

This information is provided based on reasonable inquiry of our suppliers and represents our current actual knowledge based on the information they provided. This information is subject to change. The part numbers that TE has identified as EU RoHS compliant have a maximum concentration of 0.1% by weight in homogenous materials for lead, hexavalent chromium, mercury, PBB, PBDE, DBP, BBP, DEHP, DIBP, and 0.01% for cadmium, or qualify for an exemption to these limits as defined in the Annexes of Directive 2011/65/EU (RoHS2). Finished electrical and electronic equipment products will be CE marked as required by Directive 2011/65/EU. Components may not be CE marked. Additionally, the part numbers that TE has identified as EU ELV compliant have a maximum concentration of 0.1% by weight in homogenous materials for lead, hexavalent chromium, and mercury, and 0.01% for cadmium, or qualify for an exemption to these limits as defined in the Annexes of Directive 2000/53/EC (ELV). Regarding the REACH Regulation, the information TE provides on SVHC in articles for this part number is based on the latest European Chemicals Agency (ECHA) 'Guidance on requirements for substances in articles' posted at this URL: <https://echa.europa.eu/guidance-documents/guidance-on-reach>

Compatible Parts



TE Part # CAT-M5833-F3492A  
FEMALE-ON-BOARD CONNECTOR  
TOP ENTRY



TE Part # 1-338070-0  
MICRO-MATCH FEM.SE



TE Part # 1-215460-0  
MICRO-MATCH FEM.SE



TE Part # 1-100400-0  
MICRO-MATCH FSID NP



TE Part # 8-188431-0  
M-MATCH FEM. BOTTOM ENTRY  
SMD INB.CONN.



TE Part # 1-167019-0  
10P. RIBBCBL 28AWG P1.27



TE Part # 8-215460-0  
MICRO-MATCH FSID P



TE Part # 8-100400-0  
MICRO-MATCH FSID NP



TE Part # 734155-1  
TOOLING KIT ASSY.



TE Part # 734024-1  
ADAPTER (MICROMATCH)



TE Part # 519708-1  
TERMINATION PUSHER



TE Part # 677412-4  
SEMI AUTO.MACHINE, MICRO-  
MATCH, 4-24 POS

Also in the Series | **Micro-MaTch Industrial**



Board-In Connectors(20)



Insertion & Extraction Tools(1)



PCB Headers & Receptacles(1)



Pluggable I/O Cable Assemblies(52)



Ribbon Cable Connectors(184)



Wire-to-Board Connector Contacts(4)

Customers Also Bought

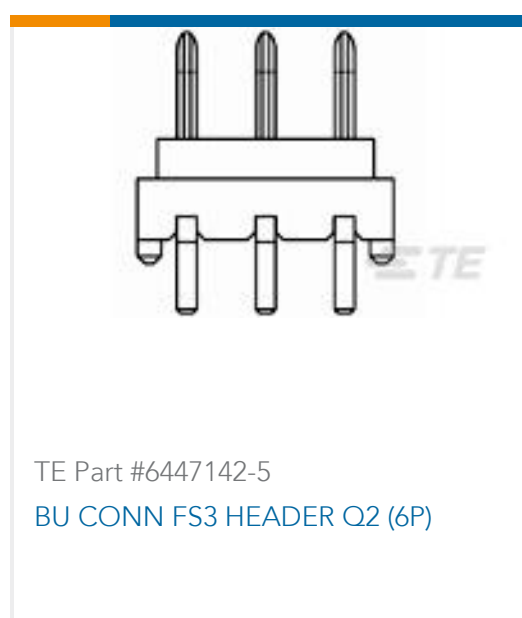
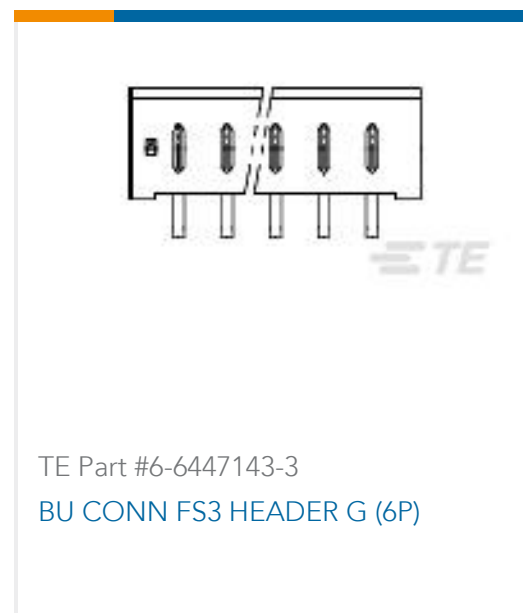
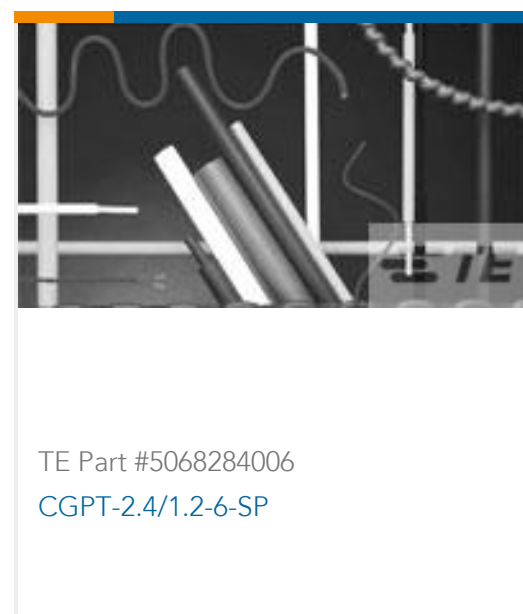

## Documents

### Product Drawings

[MICRO-MATCH MOW.10P](#)

English

### CAD Files

[3D PDF](#)

[3D](#)

[Customer View Model](#)

[ENG\\_CVM\\_CVM\\_1-215083-0\\_U.2d\\_dxf.zip](#)

English

[Customer View Model](#)

[ENG\\_CVM\\_CVM\\_1-215083-0\\_U.3d\\_igs.zip](#)

English

[Customer View Model](#)

[ENG\\_CVM\\_CVM\\_1-215083-0\\_U.3d\\_stp.zip](#)

English

By downloading the CAD file I accept and agree to the [Terms and Conditions](#) of use.

### Datasheets & Catalog Pages



[Micro-MaTch Catalog](#)

English

[Ribbon Cable Interconnect Solutions](#)

English

[Centerline Micro-Match Connector Series](#)

English

---

[Product Specifications](#)

[Application Specification](#)

English

[micro match miniature connector system](#)

English

---

[Product Environmental Compliance](#)

[MATERIAL DECLARATION 1-215083-0](#)

English

[TE Material Declaration](#)

English

---

[Agency Approvals](#)

[UL Report](#)

English