

1-480323-0 ✓ ACTIVE

MATE-N-LOK | Commercial MATE-N-LOK

TE Internal #: 1-480323-0

Rectangular Power Connectors, Housing, Plug, Wire-to-Panel /  
Wire-to-Wire, 15 Position, .202 in [5.1 mm] Centerline, Commercial  
MATE-N-LOK

[View on TE.com >](#)



Connectors > Power Connectors > Rectangular Power > Rectangular Power Connectors

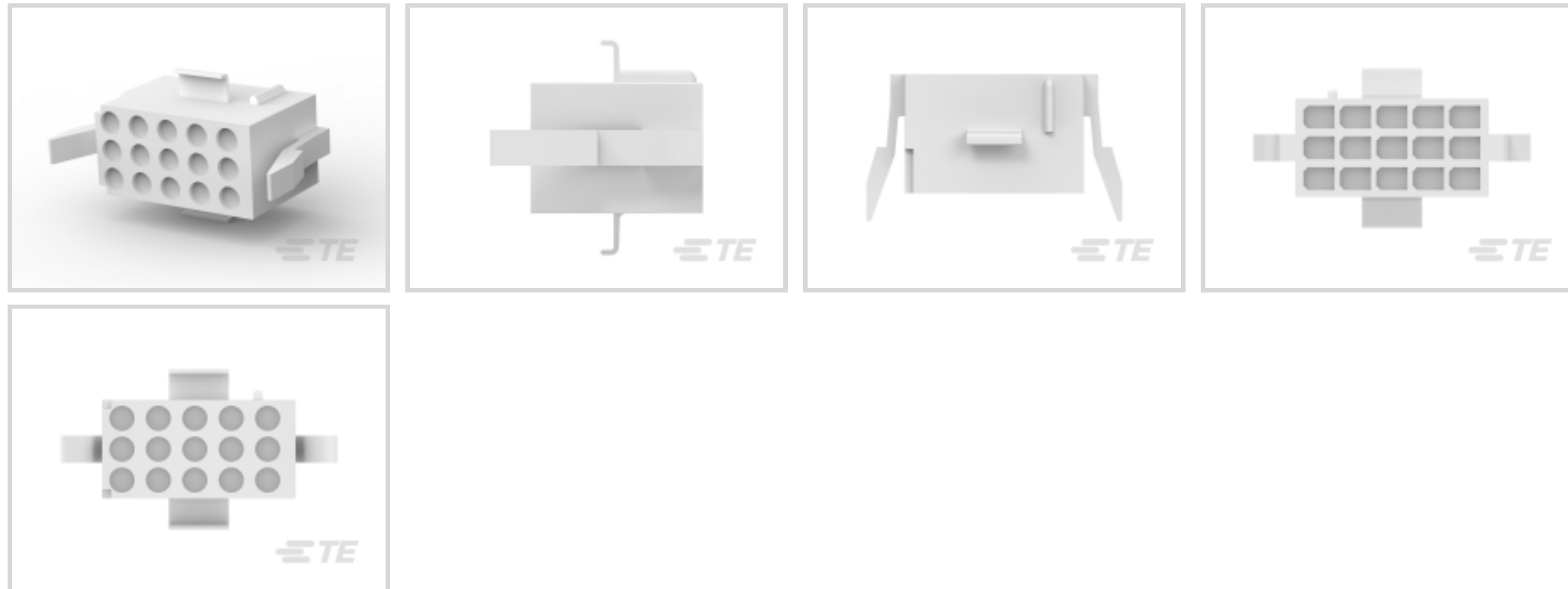

Rectangular Power Connector Type: **Housing**

Connector & Housing Type: **Plug**

Connector System: **Wire-to-Panel, Wire-to-Wire**

Number of Positions: **15**

Centerline (Pitch): **5.1 mm [ .202 in ]**

## Features

### Product Type Features

Rectangular Power Connector Type	Housing
Connector & Housing Type	Plug
Connector System	Wire-to-Panel, Wire-to-Wire
Sealable	No
Connector & Contact Terminates To	Wire & Cable

### Configuration Features

Number of Positions	15
Number of Rows	3

### Electrical Characteristics

Operating Voltage	250 VAC
-------------------	---------

### Contact Features

Contact Layout	Matrix
Contact Retention Within Housing	Without
Contact Type	Socket



### Termination Features

Termination Method to Wire & Cable	Crimp
------------------------------------	-------

### Mechanical Attachment

Panel Mount Feature	With
Panel Mount Feature Type	Locking Leg
Connector Mounting Type	Panel Mount

### Housing Features

Centerline (Pitch)	5.1 mm [.202 in]
Housing Color	Natural
Housing Material	Nylon

### Dimensions

Row-to-Row Spacing	6.09 mm [.24 in]
Panel Thickness	.64 – 1.65 mm [.025 – .065 in]

### Usage Conditions

Operating Temperature Range	-55 – 105 °C [-67 – 221 °F]
-----------------------------	-----------------------------

### Operation/Application

Circuit Application	Power & Signal
---------------------	----------------

### Identification Marking

Circuit Identification Feature	With
--------------------------------	------

### Industry Standards

UL Flammability Rating	UL 94V-2
Glow Wire Rating	Standard Part - Not Glow Wire
UL Rating	Certified, Recognized
Agency/Standard Number	E28476
CSA File Number	LR16455
VDE Tested	No
Agency/Standard	CSA, UL

### Packaging Features

Packaging Method	Package
Packaging Quantity	1

### Other



For Use With	Pin (Cap) Housing
--------------	-------------------

### Product Compliance

[For compliance documentation, visit the product page on TE.com>](#)

EU RoHS Directive 2011/65/EU	Compliant
EU ELV Directive 2000/53/EC	Compliant
China RoHS 2 Directive MIIT Order No 32, 2016	No Restricted Materials Above Threshold
EU REACH Regulation (EC) No. 1907/2006	Current ECHA Candidate List: JAN 2022 (223) Candidate List Declared Against: JAN 2022 (223) Does not contain REACH SVHC
Halogen Content	Low Halogen - Br, Cl, F, I < 900 ppm per homogenous material. Also BFR/CFR/PVC Free
Solder Process Capability	Not applicable for solder process capability













#### Product Compliance Disclaimer

This information is provided based on reasonable inquiry of our suppliers and represents our current actual knowledge based on the information they provided. This information is subject to change. The part numbers that TE has identified as EU RoHS compliant have a maximum concentration of 0.1% by weight in homogenous materials for lead, hexavalent chromium, mercury, PBB, PBDE, DBP, BBP, DEHP, DIBP, and 0.01% for cadmium, or qualify for an exemption to these limits as defined in the Annexes of Directive 2011/65/EU (RoHS2). Finished electrical and electronic equipment products will be CE marked as required by Directive 2011/65/EU. Components may not be CE marked. Additionally, the part numbers that TE has identified as EU ELV compliant have a maximum concentration of 0.1% by weight in homogenous materials for lead, hexavalent chromium, and mercury, and 0.01% for cadmium, or qualify for an exemption to these limits as defined in the Annexes of Directive 2000/53/EC (ELV). Regarding the REACH Regulation, the information TE provides on SVHC in articles for this part number is based on the latest European Chemicals Agency (ECHA) 'Guidance on requirements for substances in articles' posted at this URL: <https://echa.europa.eu/guidance-documents/guidance-on-reach>

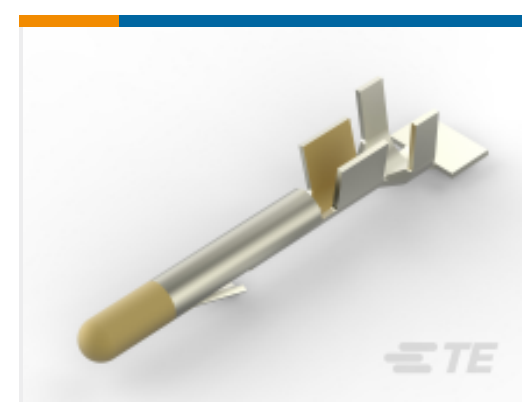
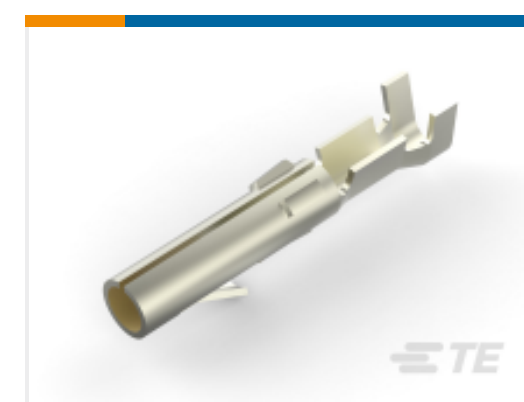

### Compatible Parts

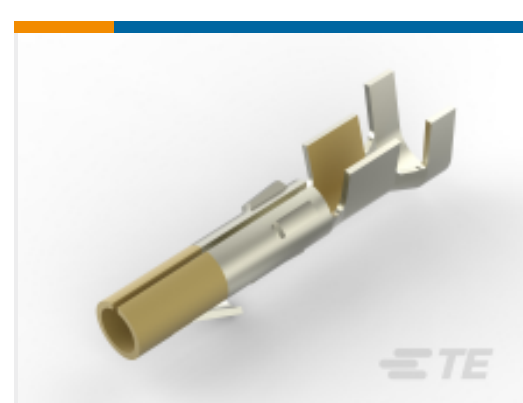
 <p>TE Part # 60619-5 CMNL SOK AUBR L/P</p>	 <p>TE Part # 60617-5 CMNL SOK AUBR L/P</p>	 <p>TE Part # 60618-5 CMNL PIN AUBR L/P</p>	 <p>TE Part # 60617-4 CMNL SOK PTPPHBZ L/P</p>
--	---	--	---

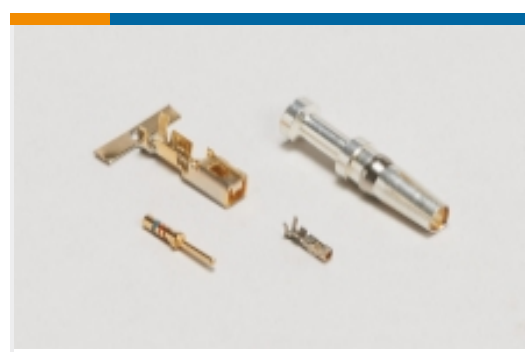

 TE Part # 61174-1 CMNL PIN L/P PTBR	 TE Part # 61173-1 CMNL SOK 30-22 PTBR L/P	 TE Part # 60619-1 CMNL SOK PTPBR L/P	 TE Part # 60620-1 CMNL PIN 20-14 TPBR L/P
 TE Part # 60617-1 CMNL SOK SNBR L/P	 TE Part # 1-480324-0 15P CMNL CAP HSG P/M NATL	 TE Part # 60620-4 CMNL PIN 20-14 TPPHBZ L/P	 TE Part # 163304-2 MATENLOK SOCKET SDW
 TE Part # 163305-2 MATENLOK PIN SDW	 TE Part # 60619-4 CMNL SOK PTPPHBZ L/P	 TE Part # 61118-5 CMNL PIN 20-14 AUNIBR	 TE Part # 61314-6 CMNL SOK S/F 24-18 .0125AUPHBZ
 TE Part # 61116-4 CMNL PIN 24-18 PTPHBZ	 TE Part # 61117-5 CMNL SOK 20-14 AUBR	 TE Part # 350557-4 MNL SOK SPECIAL .0125PTPHBZ	 TE Part # 61314-4 CMNL SOK 24-18 TPPHBZ

Also in the Series | Commercial MATE-N-LOK

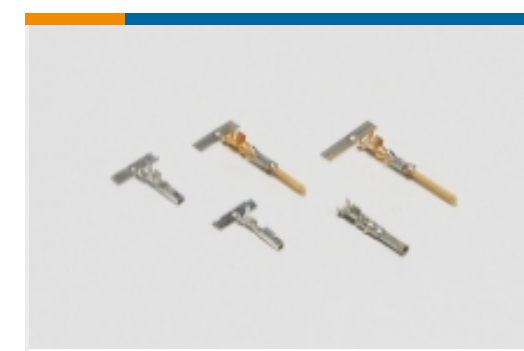
 Connector Contacts(26)	 Crimp Wire Pins, Tabs & Ferrules(3)	 Insertion & Extraction Tools(5)	 Power Contacts(129)
---	---	--	--





Rectangular Caps & Covers(2)



Rectangular Connector Housings(17)

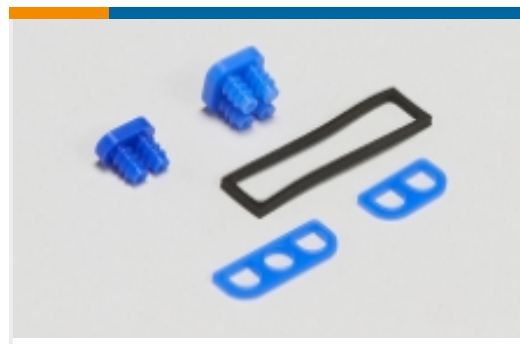

Rectangular Connector Seals(1)



Rectangular Power Connectors(170)



Standard Circular Connectors(4)



Standard Rectangular Connectors(10)



Wire-to-Board Connector Contacts(1)

## Customers Also Bought



TE Part #3-917808-2  
DYNAMIC D-5200M TAB HSG 4P X-Y

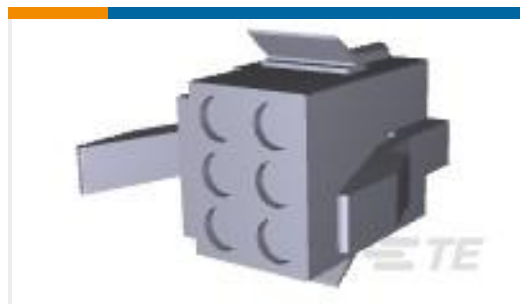

TE Part #1-171196-0  
6 POS MATE-N-LOK S



TE Part #172213-5  
EIS CAP HSG PANEL MOUNT 5P  
NATUTURAL



TE Part #172213-4  
EIS CAP HSG PANEL MOUNT 4P  
NATUTURAL



TE Part #61320-1  
CMNL PCB SOK PTPHBZ



TE Part #172021-2  
16 POS RCPT. HSG.

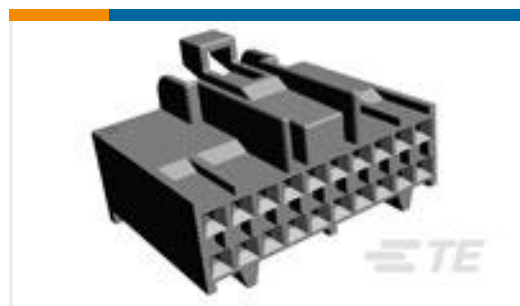

TE Part #172047-2  
DLI HSG 20 POS MOD IV TYPE



TE Part #1-913714-4  
CRIMPER,INS



TE Part #1276000-2  
CRIMPER,WIRE

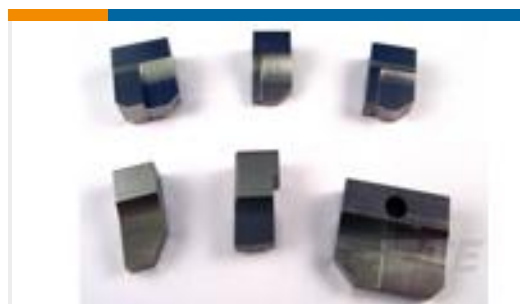

TE Part #2-409285-1  
ANVIL

## Documents



### Product Drawings

#### 15P CMNL PLUG HSG P/M NATL

English

---

### CAD Files

#### Customer View Model

[ENG\\_CVM\\_1-480323-0\\_U.3d\\_igs.zip](#)

English

#### Customer View Model

[ENG\\_CVM\\_1-480323-0\\_U.3d\\_stp.zip](#)

English

#### Customer View Model

[ENG\\_CVM\\_1-480323-0\\_U.2d\\_dxf.zip](#)

English

#### 3D PDF

English

#### 3D PDF

3D

#### Customer View Model

[ENG\\_CVM\\_CVM\\_1-480323-0\\_BB.2d\\_dxf.zip](#)

English

#### Customer View Model

[ENG\\_CVM\\_CVM\\_1-480323-0\\_BB.3d\\_igs.zip](#)

English

#### Customer View Model

[ENG\\_CVM\\_CVM\\_1-480323-0\\_BB.3d\\_stp.zip](#)

English

By downloading the CAD file I accept and agree to the [Terms and Conditions](#) of use.

---

### Datasheets & Catalog Pages

#### SOFT\_SHELL\_PIN\_SOCKET\_CONNECTORS\_STANDARD\_DENSITY

English

---

### Product Specifications

#### Application Specification

English

---

### Product Environmental Compliance

[MD\\_1-480323-0\\_060620181330\\_dmtec](#)

English

[MD\\_1-480323-0\\_060620181330\\_dmtec](#)

English

---

### Instruction Sheets

#### Instruction Sheet (U.S.)

English



[Instruction Sheet \(U.S.\)](#)

English

---

[Agency Approvals](#)

[Agency Approval Document](#)

English