

1-770010-0 ✓ ACTIVE

MATE-N-LOK | Universal MATE-N-LOK

TE Internal #: 1-770010-0

Power Contacts, Contact, 600 VAC, Gold, 24 – 18 AWG Wire Size, .2 – 1 mm<sup>2</sup> Wire Size, Wire-to-Wire, Wire & Cable, Crimp, Power, Universal MATE-N-LOK

[View on TE.com >](#)



Connectors > Power Connectors > Power Contacts



Power Contact Type: **Contact**

Operating Voltage: **600 VAC**

Contact Mating Area Plating Material: **Gold**

Wire Size: **.2 – 1 mm<sup>2</sup>**

## Features

### Product Type Features

Power Contact Type	Contact
Connector System	Wire-to-Wire
Connector & Contact Terminates To	Wire & Cable

### Electrical Characteristics

Operating Voltage	600 VAC
-------------------	---------

### Contact Features

Contact Mating Area Plating Material	Gold
Contact Current Rating (Max)	7 A
Contact Type	Socket
Contact Retention Within Housing	Without
Mating Pin Diameter	2.2 mm[.086 in]
Contact Base Material	Phosphor Bronze
Contact Mating Area Plating Material Thickness	.76 µm[30 µin]
Wire Contact Termination Area Plating Thickness	1.27 µm[50 µin]
Wire Contact Termination Area Plating Material	Tin



Wire Contact Termination Area Plating Material Finish	Matte
Contact Orientation	Straight
Contact Underplating Material	Nickel
Contact Underplating Material Thickness	1.27 µm[50 µin]

### Termination Features

Termination Method to Wire & Cable	Crimp
------------------------------------	-------

### Mechanical Attachment

Connector Mounting Type	Cable Mount (Free-Hanging)
Wire Insulation Support	Without

### Dimensions

Wire Size	.2 – 1 mm <sup>2</sup>
Accepts Wire Insulation Diameter Range	1.02 – 2.54 mm[.04 – .1 in]

### Usage Conditions

Operating Temperature Range	-55 – 120 °C[-67 – 248 °F]
-----------------------------	----------------------------

### Operation/Application

Circuit Application	Power
---------------------	-------

### Industry Standards

CSA Rating	Certified
Glow Wire Rating	Standard Part - Not Glow Wire
VDE Tested	Yes
Agency/Standard	CSA, UL
CSA File Number	LR 7189
UL Rating	Recognized
UL File Number	E28476

### Packaging Features

Packaging Method	Reel
Packaging Quantity	5000

### Other

Wire/Cable Type	Discrete Wire
Wire Type	Stranded
For Use With	Standard Universal MATE-N-LOK(Pin)



## Product Compliance

[For compliance documentation, visit the product page on TE.com>](#)

EU RoHS Directive 2011/65/EU	Compliant
EU ELV Directive 2000/53/EC	Compliant
China RoHS 2 Directive MIIT Order No 32, 2016	No Restricted Materials Above Threshold
EU REACH Regulation (EC) No. 1907/2006	Current ECHA Candidate List: JAN 2022 (223) Candidate List Declared Against: JAN 2022 (223) Does not contain REACH SVHC
Halogen Content	Low Halogen - Br, Cl, F, I < 900 ppm per homogenous material. Also BFR/CFR/PVC Free
Solder Process Capability	Not applicable for solder process capability

### Product Compliance Disclaimer

This information is provided based on reasonable inquiry of our suppliers and represents our current actual knowledge based on the information they provided. This information is subject to change. The part numbers that TE has identified as EU RoHS compliant have a maximum concentration of 0.1% by weight in homogenous materials for lead, hexavalent chromium, mercury, PBB, PBDE, DBP, BBP, DEHP, DIBP, and 0.01% for cadmium, or qualify for an exemption to these limits as defined in the Annexes of Directive 2011/65/EU (RoHS2). Finished electrical and electronic equipment products will be CE marked as required by Directive 2011/65/EU. Components may not be CE marked. Additionally, the part numbers that TE has identified as EU ELV compliant have a maximum concentration of 0.1% by weight in homogenous materials for lead, hexavalent chromium, and mercury, and 0.01% for cadmium, or qualify for an exemption to these limits as defined in the Annexes of Directive 2000/53/EC (ELV). Regarding the REACH Regulation, the information TE provides on SVHC in articles for this part number is based on the latest European Chemicals Agency (ECHA) 'Guidance on requirements for substances in articles' posted at this URL: <https://echa.europa.eu/guidance-documents/guidance-on-reach>



## Compatible Parts

 <p>TE Part # 90548-2 PROCRIMPER DIE ASSY UNIV MNL</p>	 <p>TE Part # 770022-1 12P UMNLI IN-LNE PLUG HSG KIT</p>	 <p>TE Part # 770019-1 04P UMNLI IN-LNE PLUG HSG KIT</p>	 <p>TE Part # 770028-1 09P UMNLI IN-LINE CAP HSG KIT</p>
---	---	---	---



 <p>TE Part # 770016-1 05P UMNLI IN-LNE PLUG HSG KIT</p>	 <p>TE Part # 770026-1 04P UMNLI IN-LINE CAP HSG KIT</p>	 <p>TE Part # 770024-1 02P UMNLI IN-LINE CAP HSG KIT</p>	 <p>TE Part # 770021-1 09P UMNLI IN-LNE PLUG HSG KIT</p>
 <p>TE Part # 770030-1 15P UMNLI IN-LINE CAP HSG KIT</p>	 <p>TE Part # 770018-1 03P UMNLI IN-LNE PLUG HSG KIT</p>	 <p>TE Part # 770027-1 06P UMNLI IN-LINE CAP HSG KIT</p>	 <p>TE Part # 770025-1 03P UMNLI IN-LINE CAP HSG KIT</p>
 <p>TE Part # 770017-1 02P UMNLI IN-LNE PLUG HSG KIT</p>	 <p>TE Part # 770020-1 06P UMNLI IN-LNE PLUG HSG KIT</p>	 <p>TE Part # 770023-1 15P UMNLI IN-LNE PLUG HSG KIT</p>	 <p>TE Part # 90548-1 ASSY PRO-CRIMPER UNIV M-N-L</p>
 <p>TE Part # 2305570-1 TERMINAL CUTTER, SIDE FEED</p>	 <p>TE Part # 91510-1 CCII UNML UNML II PIN SKT 24-18 ASSY</p>	 <p>TE Part # 770029-1 12P UMNLI IN-LINE CAP HSG KIT</p>	 <p>TE Part # 2-2266544-1 OCEAN_2.0_Applicator-S-070F100F</p>

Also in the Series | **Universal MATE-N-LOK**

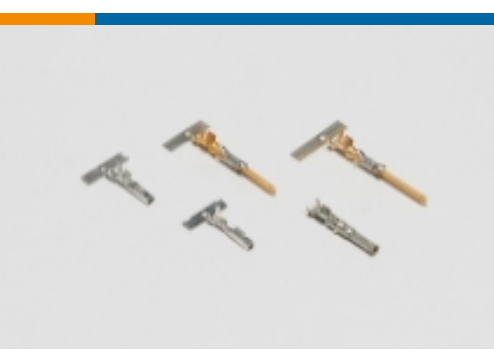
 <p>Circular Power Connectors(2)</p>	 <p>Connector Contacts(11)</p>	 <p>Insertion &amp; Extraction Tools(4)</p>	 <p>Power Contacts(207)</p>
---	---	--	--



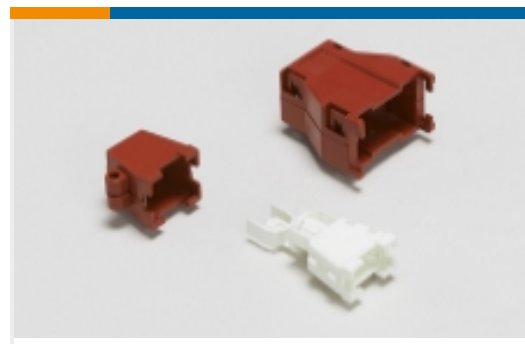

Rectangular Boots & Strain Relief(35)

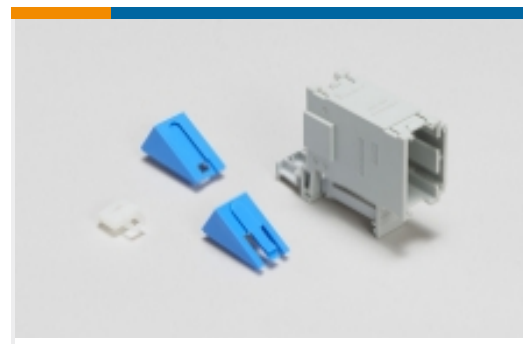

Rectangular Connector Adapters(7)

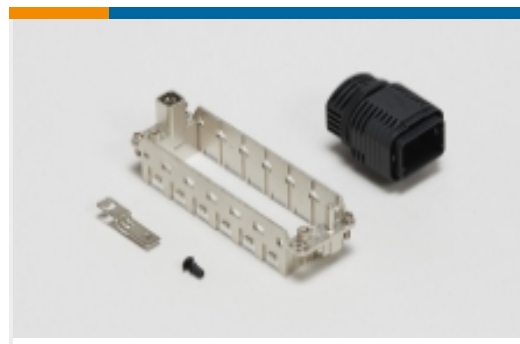

Rectangular Connector Hardware(1)



Rectangular Connector Housings(2)



Rectangular Connector Keying Plugs(3)



Rectangular Connector Locking(4)



Rectangular Connector Seals(26)



Rectangular Power Connectors(729)

## Customers Also Bought



TE Part #3-641238-9  
09P MTA100 CONN ASSY NATL 30AU



TE Part #5554346-2  
EMI RCPT ASSY, 36 POS, SHLD

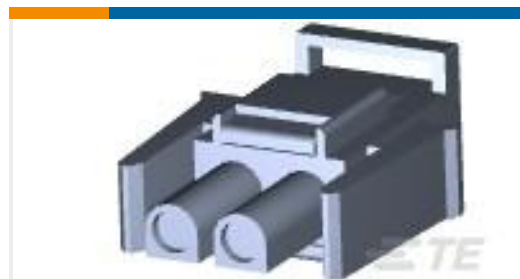

TE Part #770017-1  
02P UMNLII IN-LNE PLUG HSG KIT

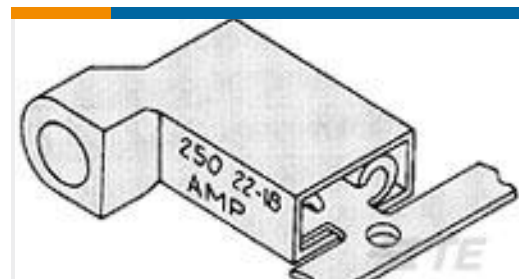

TE Part #2-520334-2  
ULTRAFast 187 ASSY FLAG REC 22-18 TPBR

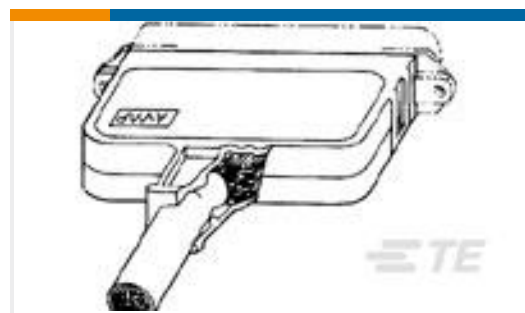

TE Part #2-552079-1  
COVER KIT 180 DEG 14 POS BLK

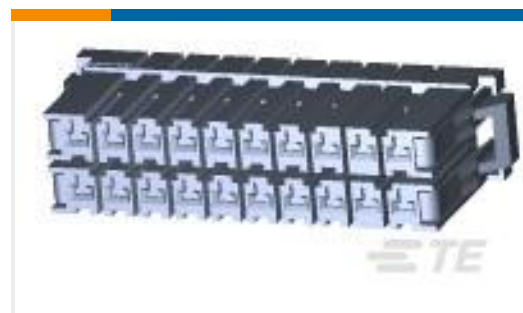

TE Part #1-917659-8  
DYNAMIC 3200 REC HSG 20P



TE Part #175218-2  
DYNAMIC REC CONTACT L L/P



TE Part #2-520401-2  
ULTRA-FAST 187 ASY REC 22-18 TPBR



TE Part #1-770007-0  
UMNL II PIN AUSN/NI/BR

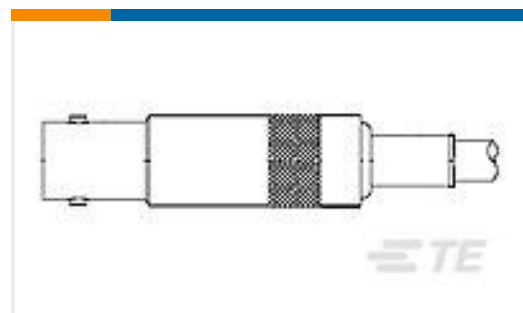

TE Part #5225087-5  
SHV JACK

## Documents



## Product Drawings

### UMNL II SOK SN/AUNI/PHBZ LF

English

## CAD Files

### 3D PDF

English

### Customer View Model

[ENG\\_CVM\\_1-770010-0\\_E.3d\\_igs.zip](#)

English

### Customer View Model

[ENG\\_CVM\\_1-770010-0\\_E.3d\\_stp.zip](#)

English

### Customer View Model

[ENG\\_CVM\\_1-770010-0\\_E.2d\\_dxf.zip](#)

English

### 3D PDF

3D

### Customer View Model

[ENG\\_CVM\\_CVM\\_1-770010-0\\_P.2d\\_dxf.zip](#)

English

### Customer View Model

[ENG\\_CVM\\_CVM\\_1-770010-0\\_P.3d\\_igs.zip](#)

English

### Customer View Model

[ENG\\_CVM\\_CVM\\_1-770010-0\\_P.3d\\_stp.zip](#)

English

By downloading the CAD file I accept and agree to the [Terms and Conditions](#) of use.

## Datasheets & Catalog Pages

### SOFT\_SHELL\_PIN\_SOCKET\_CONNECTORS\_STANDARD\_DENSITY

English

## Product Specifications

### Application Specification

English

## Product Environmental Compliance

### MD\_1-770010-0\_11302016149\_dmtec

English

### MD\_1-770010-0\_11302016149\_dmtec

English