



Dynamic Series | Dynamic 1000 Series

TE Internal #: 1-1903130-2

Housing, Housing for Male Terminals, Wire-to-Wire, 4 Position, 2.5 mm [.098 in] Centerline, Crimp, 2 Row, Black, Mating Retention, Dynamic 1000 Series

[View on TE.com >](#)

Connectors > PCB Connectors > Wire-to-Board Connectors > Wire-to-Board Connector Assemblies & Housings >

Receptacle and Tab Housing: 2.5 mm pitch, 250V



Connector Product Type: **Housing**

Connector & Housing Type: **Housing for Male Terminals**

Connector System: **Wire-to-Wire**

Number of Positions: **4**

Centerline (Pitch): **2.5 mm [.098 in]**

[All Receptacle and Tab Housing: 2.5 mm pitch, 250V \(59\)](#)

Features

Product Type Features

Connector Product Type	Housing
Connector & Housing Type	Housing for Male Terminals
Connector System	Wire-to-Wire
Sealable	No
Connector & Contact Terminates To	Wire & Cable

Configuration Features

Number of Positions	4
Number of Rows	2

Termination Features

Termination Method to Wire & Cable	Crimp
------------------------------------	-------

Mechanical Attachment

--	--



Mating Retention	With
------------------	------

Connector Mounting Type	Cable Mount (Free-Hanging)
-------------------------	----------------------------

Housing Features

Centerline (Pitch)	2.5 mm [.098 in]
--------------------	------------------

Housing Color	Black
---------------	-------

Dimensions

Row-to-Row Spacing	3.3 mm [.129 in]
--------------------	------------------

Usage Conditions

Operating Temperature Range	-55 – 105 °C [-67 – 221 °F]
-----------------------------	-----------------------------

Operation/Application

Circuit Application	Signal
---------------------	--------

Product Compliance

[For compliance documentation, visit the product page on TE.com>](#)

EU RoHS Directive 2011/65/EU	Compliant
------------------------------	-----------

EU ELV Directive 2000/53/EC	Compliant
-----------------------------	-----------

China RoHS 2 Directive MIIT Order No 32, 2016	No Restricted Materials Above Threshold
---	---

EU REACH Regulation (EC) No. 1907/2006	Current ECHA Candidate List: JAN 2022 (223) Candidate List Declared Against: JAN 2022 (223) Does not contain REACH SVHC
--	---

Halogen Content	Not Low Halogen - contains Br or Cl > 900 ppm.
-----------------	--

Solder Process Capability	Not applicable for solder process capability
---------------------------	--

Product Compliance Disclaimer

This information is provided based on reasonable inquiry of our suppliers and represents our current actual knowledge based on the information they provided. This information is subject to change. The part numbers that TE has identified as EU RoHS compliant have a maximum concentration of 0.1% by weight in homogenous materials for lead, hexavalent chromium, mercury, PBB, PBDE, DBP, BBP, DEHP, DIBP, and 0.01% for cadmium, or qualify for an exemption to these limits as defined in the Annexes of Directive 2011/65/EU (RoHS2). Finished electrical and electronic equipment products will be CE marked as required by Directive 2011/65/EU. Components may not be CE marked. Additionally, the part numbers that TE has identified as EU ELV compliant have a maximum concentration of 0.1% by weight in homogenous materials for lead, hexavalent chromium, and mercury, and 0.01% for cadmium, or qualify for an exemption to these limits as defined in the Annexes of Directive 2000/53/EC (ELV). Regarding the REACH Regulation, the information TE provides on SVHC in articles for this part number is based on the latest European Chemicals Agency (ECHA) 'Guidance on requirements for substances in articles' posted at this URL: <https://echa.europa.eu/guidance-documents/guidance-on-reach>

Compatible Parts



Also in the Series | Dynamic 1000 Series

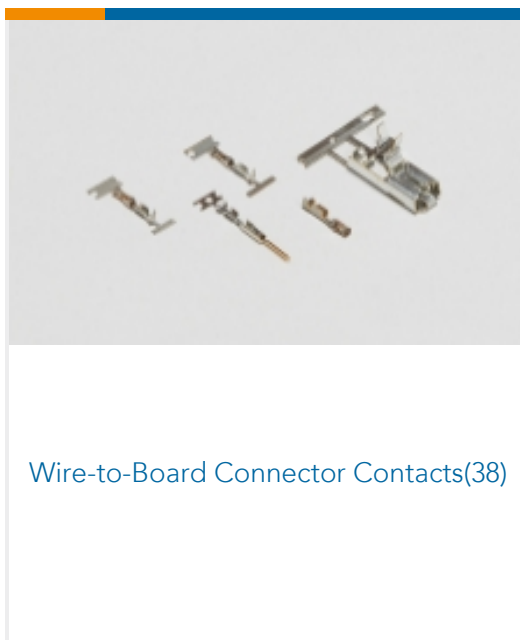
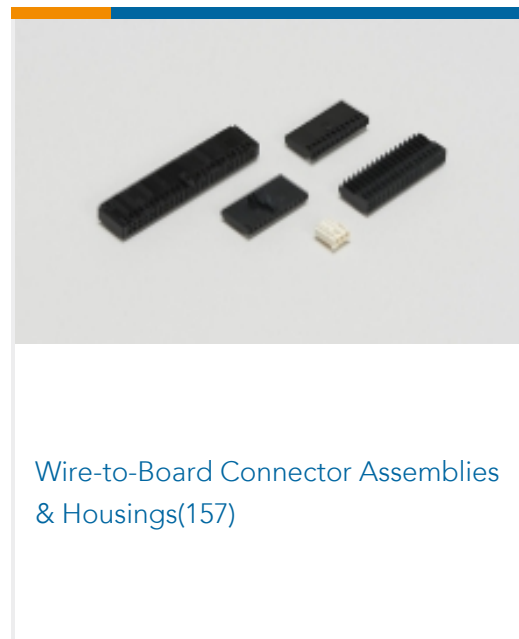
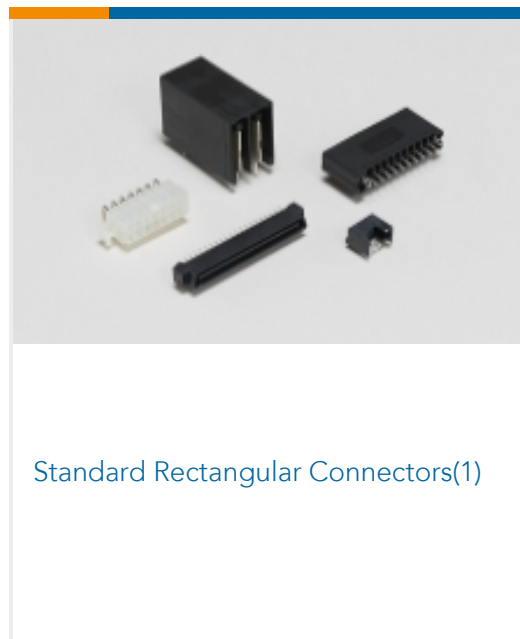
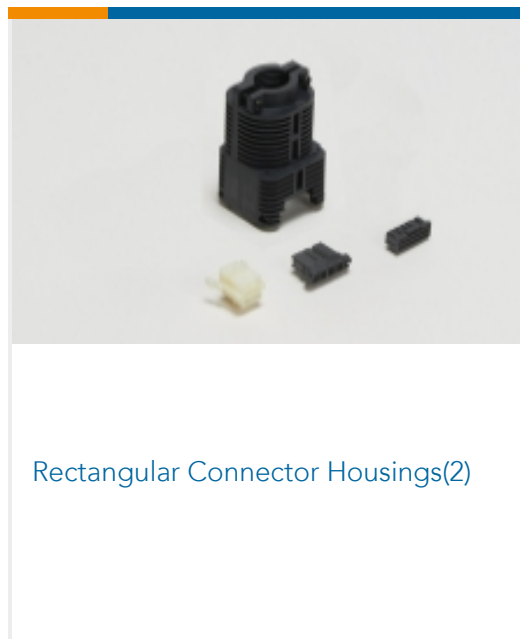
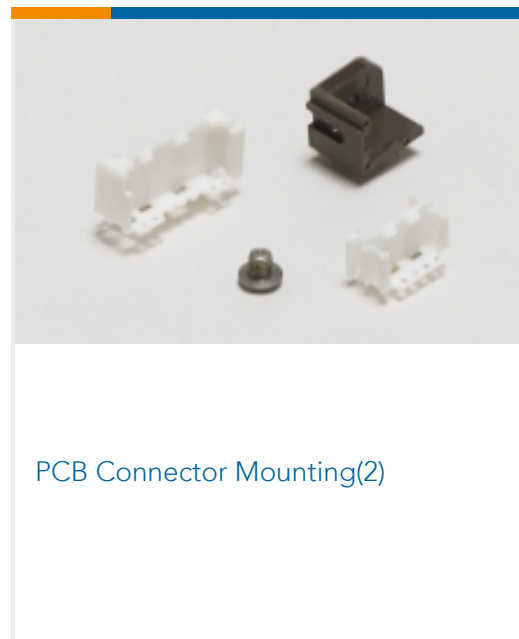
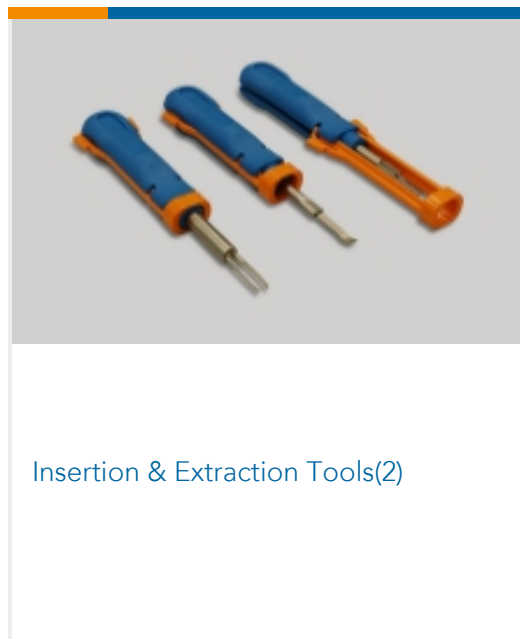
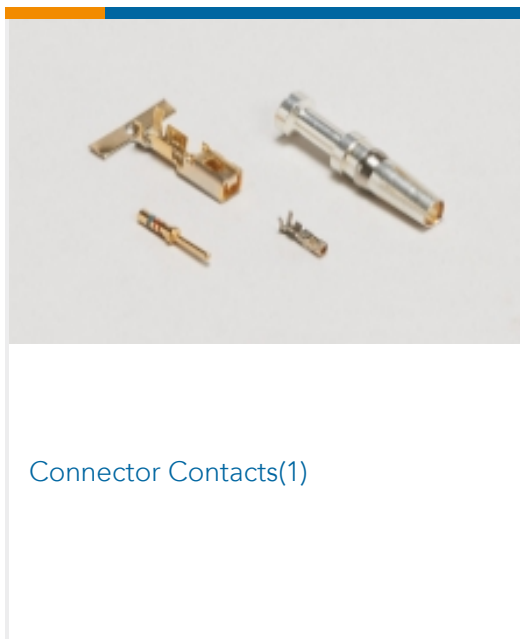

Customers Also Bought

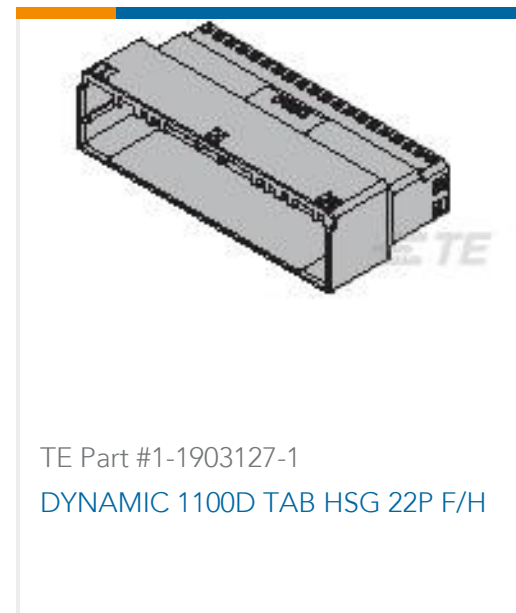

Documents

Product Drawings

[DYNAMIC 1200D TAB HSG 4P F/H](#)

English

CAD Files

[3D PDF](#)

3D

Customer View Model

[ENG_CVM_CVM_1-1903130-2_F.2d_dxf.zip](#)

English

Customer View Model

[ENG_CVM_CVM_1-1903130-2_F.3d_igs.zip](#)

English

Customer View Model

[ENG_CVM_CVM_1-1903130-2_F.3d_stp.zip](#)

English

By downloading the CAD file I accept and agree to the [Terms and Conditions](#) of use.

Datasheets & Catalog Pages

[1-1773732-4_DYNAMIC_SERIES_CATALOG_ENGLISH](#)

Japanese

[1-1773732-4_DYNAMIC_SERIES_CATALOG_ENGLISH](#)

English

Product Specifications

[Product Specification](#)

English

[Product Specification](#)

English

Product Environmental Compliance

[MD_1-1903130-2_06302017510_dmtec](#)

English

[MD_1-1903130-2_06302017510_dmtec](#)

English

1-1903130-2

Housing, Housing for Male Terminals, Wire-to-Wire, 4 Position, 2.5 mm [.098 in]
Centerline, Crimp, 2 Row, Black, Mating Retention, Dynamic 1000 Series



Instruction Sheets

Instruction Sheet (non U.S.)

English