

1-735075-0 ✓ ACTIVE

FASTON | FASTON 250

TE Internal #: 1-735075-0

Crimp Terminal Housings, Receptacle, Receptacle, 1 Position,  
Straight, UL 94V-2, Natural, Polyamide, Mating Alignment, FASTON  
250

[View on TE.com >](#)



Terminals & Splices > Terminal Housings, Insulation Sleeves & Blocks > Crimp Terminal Housings



Terminal Type: **Receptacle**

Housing Type: **Receptacle**

Number of Positions: **1**

Terminal Orientation: **Straight**

UL Flammability Rating: **UL 94V-2**

## Features

### Product Type Features

Product Type	Terminal Housing
Sealable	No
Housing Type	Receptacle
Insulated	No

### Configuration Features

Number of Positions	1
---------------------	---

### Body Features

Primary Product Color	Natural
-----------------------	---------

### Contact Features

Terminal Type	Receptacle
Terminal Orientation	Straight
Contact Mating Retention	Without

### Mechanical Attachment

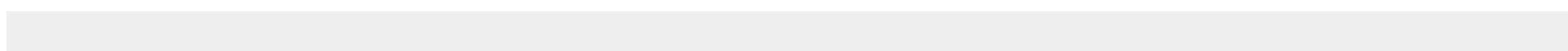

Mating Alignment	With
Crimp Terminal Housing Mounting Style	Cable Mount (Free-Hanging)

### Housing Features

Housing Material	Polyamide
------------------	-----------

### Dimensions

Length	24.4 mm[.961 in]
--------	------------------

### Usage Conditions

Operating Temperature Range	-40 – 105 °C[-40 – 221 °F]
-----------------------------	----------------------------

### Industry Standards

UL Flammability Rating	UL 94V-2
------------------------	----------

### Packaging Features

Packaging Quantity	20000
--------------------	-------

## Product Compliance

[For compliance documentation, visit the product page on TE.com>](#)

EU RoHS Directive 2011/65/EU	Compliant
EU ELV Directive 2000/53/EC	Compliant
China RoHS 2 Directive MIIT Order No 32, 2016	No Restricted Materials Above Threshold
EU REACH Regulation (EC) No. 1907/2006	Current ECHA Candidate List: JAN 2022 (223) Candidate List Declared Against: JAN 2022 (223) Does not contain REACH SVHC
Halogen Content	Low Halogen - Br, Cl, F, I < 900 ppm per homogenous material. Also BFR/CFR/PVC Free
Solder Process Capability	Not applicable for solder process capability

#### Product Compliance Disclaimer

This information is provided based on reasonable inquiry of our suppliers and represents our current actual knowledge based on the information they provided. This information is subject to change. The part numbers that TE has identified as EU RoHS compliant have a maximum concentration of 0.1% by weight in homogenous materials for lead, hexavalent chromium, mercury, PBB, PBDE, DBP, BBP, DEHP, DIBP, and 0.01% for cadmium, or qualify for an exemption to these limits as defined in the Annexes of Directive 2011/65/EU (RoHS2). Finished electrical and electronic equipment products will be CE marked as required by Directive 2011/65/EU. Components may not be CE marked. Additionally, the part numbers that TE has identified as EU ELV compliant have a maximum concentration of 0.1% by weight in homogenous materials for lead, hexavalent chromium, and mercury, and 0.01% for cadmium, or qualify for an exemption to these limits as defined in the Annexes of Directive 2000/53/EC (ELV). Regarding the REACH Regulation, the information TE provides on SVHC in articles for this part number is based on the latest European Chemicals Agency (ECHA) 'Guidance on requirements for substances in articles' posted at this URL: <https://echa.europa.eu/guidance-documents/guidance-on-reach>

## Compatible Parts

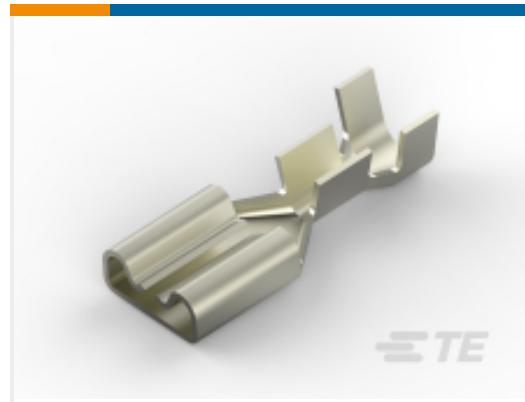

TE Part # 1742198-1  
250 FASTON, REC., 18-14 AWG, NPST



TE Part # 444335-1  
250 FASTON REC 16-14 AWG BR



TE Part # 2238204-3  
250 FASTON, REC., 22-18 AWG, PTBR



TE Part # 969518-2  
250 FASTON HSG. REC. 1P NATURAL

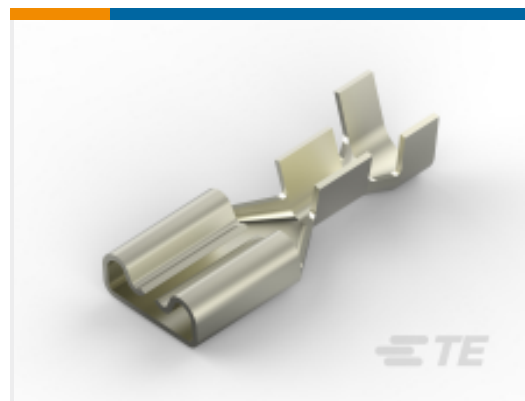

TE Part # 2238143-1  
250 FASTON, REC., 22-18 AWG, NPST



TE Part # 2238173-3  
250 FASTON, REC., 22-12 AWG, TPBR

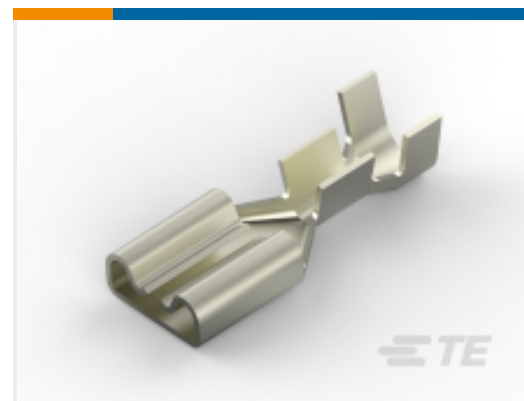

TE Part # 2238196-3  
250 FASTON, REC., 18-14 AWG, TPBR

## Also in the Series | FASTON 250



Compression Connectors(4)



Crimp Terminal Housings(143)



Insertion & Extraction Tools(6)



Magnet Wire Terminals(1)



PCB Terminals(144)



Quick Disconnects(456)



Splices(4)

## Customers Also Bought



TE Part #881607-2  
110 FASTON REC 20-17 AWG TPBR



TE Part #3-2112780-7  
18POS, MIXED, REC HSG, ASSY, SEALED



TE Part #881624-2  
187 FASTON REC 17-14 AWG TPBR



TE Part #626094-2  
FF .250 REC 0.5 /1.0 MM2 0.32X19.3 TPBR



TE Part #348989-1  
0.5MM CABLE SEAL LC RED



TE Part #170002-7  
TERMINAL GROUP NUMBER

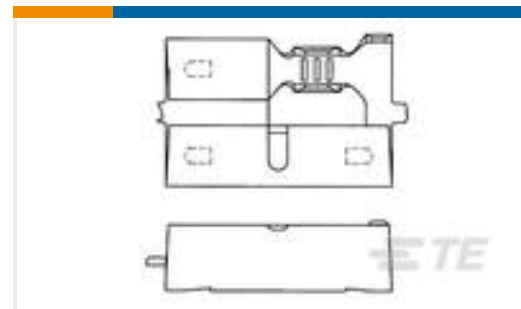

TE Part #880142-1  
.156 DIA SHUR PLUG REC

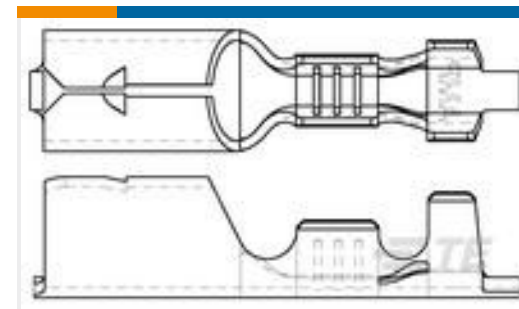

TE Part #881724-1  
.156 DIA SHUR PWG R



TE Part #444012-2  
POSITIVE MATE REC

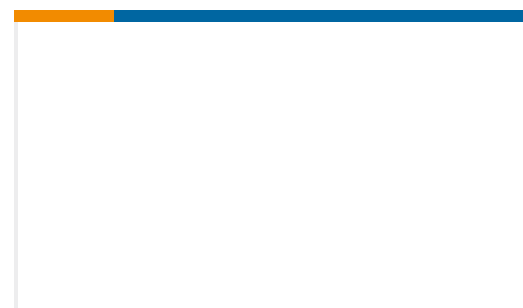

TE Part #CV16686001  
RNF-3000-NR553-0-17MM

## Documents

### Product Drawings

250 FASTON INS POST, REC., 1 POS

English

### CAD Files

Customer View Model

[ENG\\_CVM\\_CVM\\_1-735075-0\\_AW.2d\\_dxf.zip](#)

English

### 3D PDF

3D

Customer View Model

[ENG\\_CVM\\_CVM\\_1-735075-0\\_AW.3d\\_igs.zip](#)

English

Customer View Model

[ENG\\_CVM\\_CVM\\_1-735075-0\\_AW.3d\\_stp.zip](#)

English

By downloading the CAD file I accept and agree to the [Terms and Conditions](#) of use.

## Product Specifications



## 6,35 FASTON RECPTACLES AND TAB SLEEVES

English

### Product Specification

English

---

### Product Environmental Compliance

[MD\\_1-735075-0\\_071120122358](#)

English

[MD\\_1-735075-0\\_071120122358](#)

English