

1-794219-0 ✓ ACTIVE

MATE-N-LOK | Mini-Universal MATE-N-LOK 2

TE Internal #: 1-794219-0

Power Contacts, Contact, 600 VAC, 600 VDC, Gold, 26 – 22 AWG

Wire Size, .12 – .4 mm<sup>2</sup> Wire Size, Wire-to-Wire, Mini-Universal

MATE-N-LOK 2

[View on TE.com >](#)



Connectors > Power Connectors > Power Contacts



Power Contact Type: **Contact**

Operating Voltage: **600 VDC**

Contact Mating Area Plating Material: **Gold**

Wire Size: **26 – 22 AWG**

## Features

### Product Type Features

Power Contact Type	Contact
Connector System	Wire-to-Wire
Connector & Contact Terminates To	Wire & Cable

### Electrical Characteristics

Operating Voltage	600 VDC
-------------------	---------

### Contact Features

Contact Mating Area Plating Material	Gold
Contact Current Rating (Max)	10.5 A
Contact Type	Socket
Contact Retention Within Housing	Without
Mating Pin Diameter	1 mm [.039 in]
Contact Base Material	Brass
Contact Mating Area Plating Material Thickness	.76 µm [30 µin]
Wire Contact Termination Area Plating Thickness	2.54 µm [100 µin]
Wire Contact Termination Area Plating Material	Tin

Wire Contact Termination Area Plating Material Finish	Matte
Contact Orientation	Straight
Contact Underplating Material	Nickel
Contact Underplating Material Thickness	1.27 µm[50 µin]

### Termination Features

Termination Method to Wire & Cable	Crimp
------------------------------------	-------

### Mechanical Attachment

Connector Mounting Type	Cable Mount (Free-Hanging)
Wire Insulation Support	Without

### Dimensions

Wire Size	.12 – .4 mm <sup>2</sup>
Accepts Wire Insulation Diameter Range	1.19 – 1.75 mm[.047 – .069 in]

### Usage Conditions

Operating Temperature Range	-55 – 105 °C[-67 – 221 °F]
-----------------------------	----------------------------

### Operation/Application

Circuit Application	Power
---------------------	-------

### Industry Standards

CSA Rating	Certified
Glow Wire Rating	Standard Part - Not Glow Wire
VDE Tested	No
Agency/Standard	CSA, UL
CSA File Number	LR 7189
UL Rating	Recognized
UL Flammability Rating	UL 94V-0, UL 94V-2
UL File Number	E28476

### Packaging Features

Packaging Method	Reel
Packaging Quantity	7000

### Other

Wire/Cable Type	Discrete Wire
Wire Type	Stranded



For Use With	Plug Housing
--------------	--------------

### Product Compliance

[For compliance documentation, visit the product page on TE.com>](#)

EU RoHS Directive 2011/65/EU	Compliant
EU ELV Directive 2000/53/EC	Compliant
China RoHS 2 Directive MIIT Order No 32, 2016	No Restricted Materials Above Threshold
EU REACH Regulation (EC) No. 1907/2006	Current ECHA Candidate List: JAN 2022 (223) Candidate List Declared Against: JAN 2022 (223) Does not contain REACH SVHC
Halogen Content	Low Halogen - Br, Cl, F, I < 900 ppm per homogenous material. Also BFR/CFR/PVC Free
Solder Process Capability	Not applicable for solder process capability

#### Product Compliance Disclaimer

This information is provided based on reasonable inquiry of our suppliers and represents our current actual knowledge based on the information they provided. This information is subject to change. The part numbers that TE has identified as EU RoHS compliant have a maximum concentration of 0.1% by weight in homogenous materials for lead, hexavalent chromium, mercury, PBB, PBDE, DBP, BBP, DEHP, DIBP, and 0.01% for cadmium, or qualify for an exemption to these limits as defined in the Annexes of Directive 2011/65/EU (RoHS2). Finished electrical and electronic equipment products will be CE marked as required by Directive 2011/65/EU. Components may not be CE marked. Additionally, the part numbers that TE has identified as EU ELV compliant have a maximum concentration of 0.1% by weight in homogenous materials for lead, hexavalent chromium, and mercury, and 0.01% for cadmium, or qualify for an exemption to these limits as defined in the Annexes of Directive 2000/53/EC (ELV). Regarding the REACH Regulation, the information TE provides on SVHC in articles for this part number is based on the latest European Chemicals Agency (ECHA) 'Guidance on requirements for substances in articles' posted at this URL: <https://echa.europa.eu/guidance-documents/guidance-on-reach>

### Compatible Parts

 <p>TE Part # 90758-2 PROCrimp Die Mini Univ MNL</p>	 <p>TE Part # 189727-1 EXTRACTION TOOL</p>	 <p>TE Part # 455830-1 INSERTION TOOL</p>	 <p>TE Part # 794215-1 24P MINI UMNL2 CAP HSG UL94V0</p>
---	---	--	---

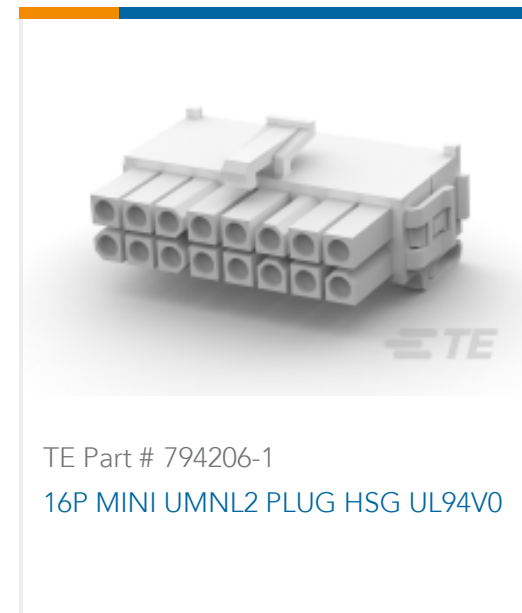

Also in the Series | **Mini-Universal MATE-N-LOK 2**

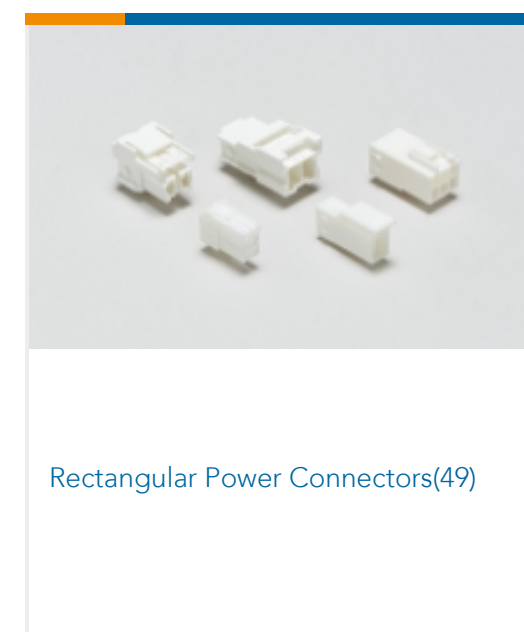
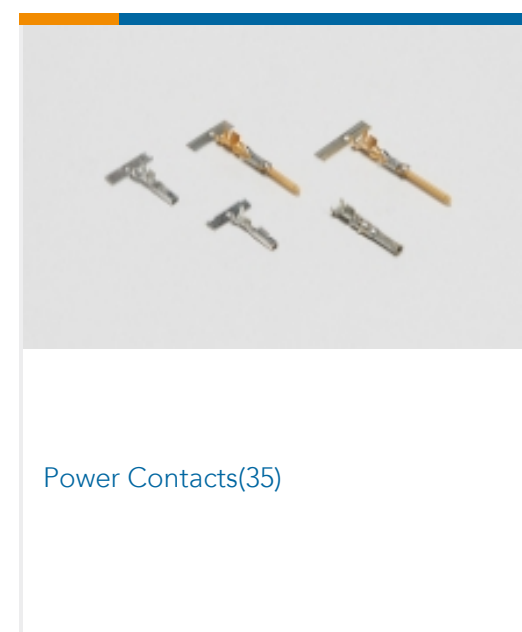
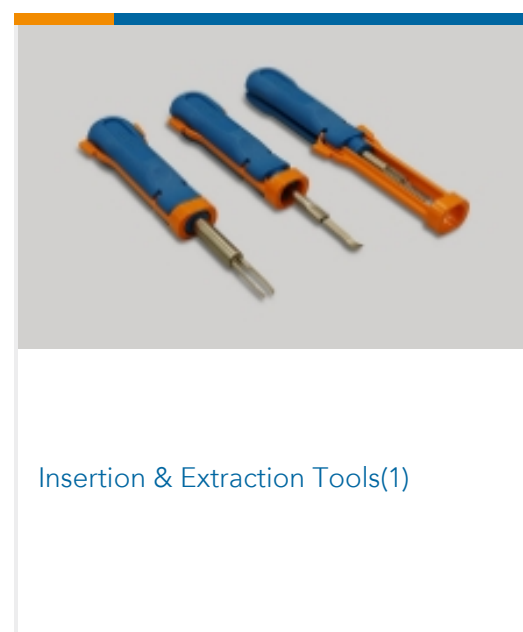
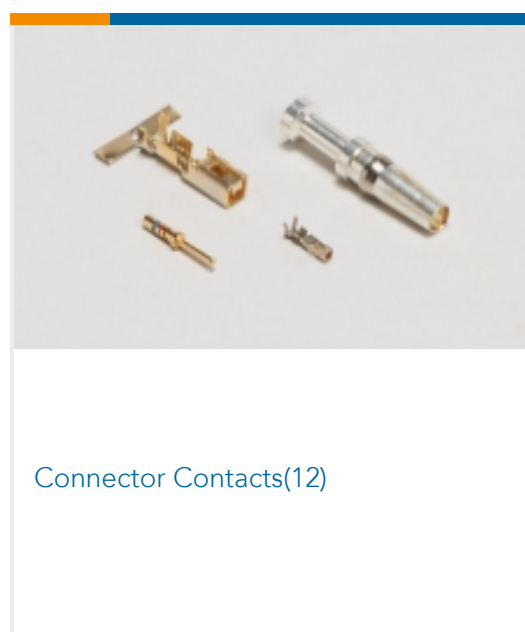

Customers Also Bought



TE Part #3-644663-4  
04P MTA156 CONN ASSY 20AWG LF

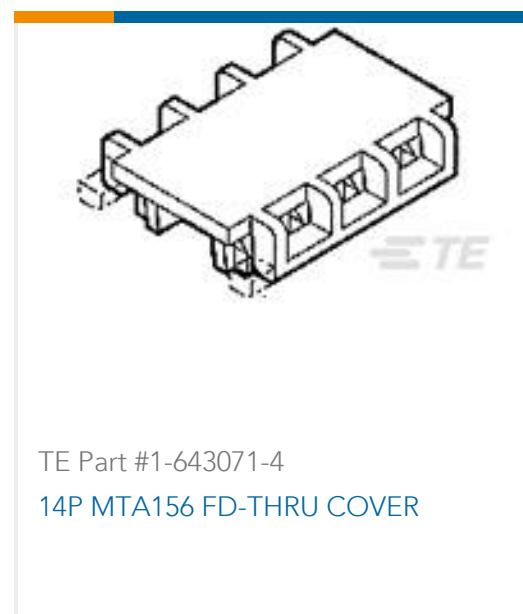

TE Part #1-643071-4  
14P MTA156 FD-THRU COVER



TE Part #103974-1  
10X2 MTE RCPT SR PLAIN .100CL



TE Part #3-644662-9  
09P MTA156 CONN ASSY 22AWG LF



TE Part #3-644663-8  
08P MTA156 CONN ASSY 20AWG LF



TE Part #240642-8  
PLATE, FRONT SHEAR



TE Part #04SZQLF001  
MS# 101-5786 Rev. 4

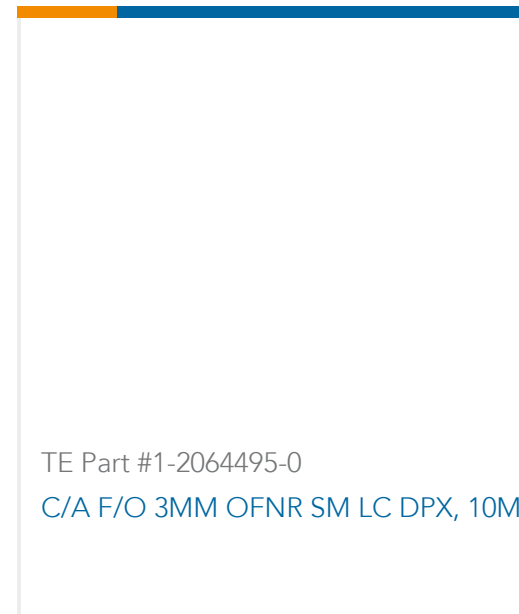

TE Part #1-2064495-0  
C/A F/O 3MM OFNR SM LC DPX, 10M

## Documents

### CAD Files

#### 3D PDF

3D

#### Customer View Model

[ENG\\_CVM\\_CVM\\_1-794219-0\\_N.2d\\_dxf.zip](#)

English

#### Customer View Model

[ENG\\_CVM\\_CVM\\_1-794219-0\\_N.3d\\_igs.zip](#)

English

#### Customer View Model

[ENG\\_CVM\\_CVM\\_1-794219-0\\_N.3d\\_stp.zip](#)

English

By downloading the CAD file I accept and agree to the [Terms and Conditions](#) of use.

### Datasheets & Catalog Pages

[SOFT\\_SHELL\\_PIN\\_AND\\_SOCKET\\_CONNECTORS\\_CATALOG](#)

English

### Product Specifications

[Product Specification](#)

English

### Product Environmental Compliance

[TE Material Declaration](#)

English

[MD\\_1-794219-0\\_04042014235\\_dmtec](#)

English

1-794219-0

Power Contacts, Contact, 600 VAC, 600 VDC, Gold, 26 – 22 AWG Wire Size, .12 – .4 mm<sup>2</sup> Wire Size, Wire-to-Wire, Mini-Universal MATE-N-LOK 2



[MD\\_1-794219-0\\_04042014235\\_dmtec](#)

English