

1-172163-9 ✓ ACTIVE

MATE-N-LOK | Mini-Universal MATE-N-LOK

TE Internal #: 1-172163-9

Rectangular Power Connectors, Housing, Receptacle, Wire-to-Panel / Wire-to-Wire, 15 Position, .165 in [4.2 mm] Centerline, Mini-Universal MATE-N-LOK

[View on TE.com >](#)



Connectors > Power Connectors > Rectangular Power > Rectangular Power Connectors



Rectangular Power Connector Type: **Housing**

Connector & Housing Type: **Receptacle**

Connector System: **Wire-to-Panel, Wire-to-Wire**

Number of Positions: **15**

Centerline (Pitch): **4.2 mm [ .165 in ]**

## Features

### Product Type Features

Rectangular Power Connector Type	Housing
Connector & Housing Type	Receptacle
Connector System	Wire-to-Panel, Wire-to-Wire
Sealable	No
Connector & Contact Terminates To	Wire & Cable

### Configuration Features

Number of Positions	15
Number of Rows	3

### Electrical Characteristics

Operating Voltage	600 VDC
-------------------	---------

### Contact Features

Contact Layout	Matrix
Multiple Contact Types	Without
Contact Retention Within Housing	Without



Contact Type	Pin
--------------	-----

### Termination Features

Termination Method to Wire & Cable	Crimp
------------------------------------	-------

### Mechanical Attachment

Panel Mount Feature	With
---------------------	------

Panel Mount Feature Type	Mounting Ears
--------------------------	---------------

Connector Mounting Type	Panel Mount
-------------------------	-------------

### Housing Features

Centerline (Pitch)	4.2 mm [.165 in]
--------------------	------------------

Housing Color	Black
---------------	-------

Housing Material	Nylon 66
------------------	----------

### Dimensions

Row-to-Row Spacing	4.2 mm [.165 in]
--------------------	------------------

Width	14.55 mm
-------	----------

Panel Thickness	.8 – 2 mm [.031 – .078 in]
-----------------	----------------------------

Length	27.5 mm
--------	---------

### Usage Conditions

Operating Temperature Range	-20 – 105 °C [-4 – 221 °F]
-----------------------------	----------------------------

### Operation/Application

Assembly Integration Feature	Without
------------------------------	---------

Circuit Application	Power & Signal
---------------------	----------------

### Identification Marking

Circuit Identification Feature	With
--------------------------------	------

### Industry Standards

CSA Rating	Certified
------------	-----------

UL Flammability Rating	UL 94V-0
------------------------	----------

Glow Wire Rating	Standard Part - Not Glow Wire
------------------	-------------------------------

Agency/Standard Number	E28476
------------------------	--------

Agency/Standard	CSA, UL
-----------------	---------

UL Rating	Recognized
-----------	------------

CSA File Number	LR7189
-----------------	--------



VDE Tested	No
------------	----

### Packaging Features

Packaging Method	Bag
Packaging Quantity	500

### Other

For Use With	Mini-Universal MATE-N-LOK Cap Housing
--------------	---------------------------------------

### Product Compliance

[For compliance documentation, visit the product page on TE.com>](#)

EU RoHS Directive 2011/65/EU	Compliant
EU ELV Directive 2000/53/EC	Compliant
China RoHS 2 Directive MIIT Order No 32, 2016	No Restricted Materials Above Threshold
EU REACH Regulation (EC) No. 1907/2006	Current ECHA Candidate List: JAN 2022 (223) Candidate List Declared Against: JAN 2021 (211) SVHC > Threshold: Not Yet Reviewed
Halogen Content	Low Halogen - Br, Cl, F, I < 900 ppm per homogenous material. Also BFR/CFR/PVC Free
Solder Process Capability	Not applicable for solder process capability

#### Product Compliance Disclaimer

This information is provided based on reasonable inquiry of our suppliers and represents our current actual knowledge based on the information they provided. This information is subject to change. The part numbers that TE has identified as EU RoHS compliant have a maximum concentration of 0.1% by weight in homogenous materials for lead, hexavalent chromium, mercury, PBB, PBDE, DBP, BBP, DEHP, DIBP, and 0.01% for cadmium, or qualify for an exemption to these limits as defined in the Annexes of Directive 2011/65/EU (RoHS2). Finished electrical and electronic equipment products will be CE marked as required by Directive 2011/65/EU. Components may not be CE marked. Additionally, the part numbers that TE has identified as EU ELV compliant have a maximum concentration of 0.1% by weight in homogenous materials for lead, hexavalent chromium, and mercury, and 0.01% for cadmium, or qualify for an exemption to these limits as defined in the Annexes of Directive 2000/53/EC (ELV). Regarding the REACH Regulation, the information TE provides on SVHC in articles for this part number is based on the latest European Chemicals Agency (ECHA) 'Guidance on requirements for substances in articles' posted at this URL: <https://echa.europa.eu/guidance-documents/guidance-on-reach>

### Compatible Parts





## Also in the Series | Mini-Universal MATE-N-LOK

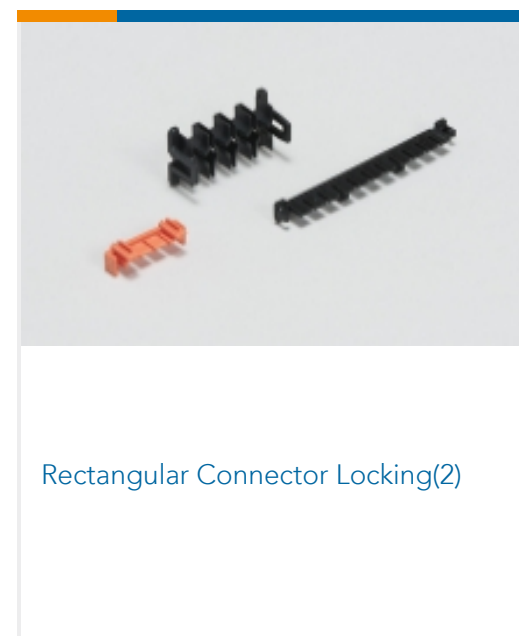
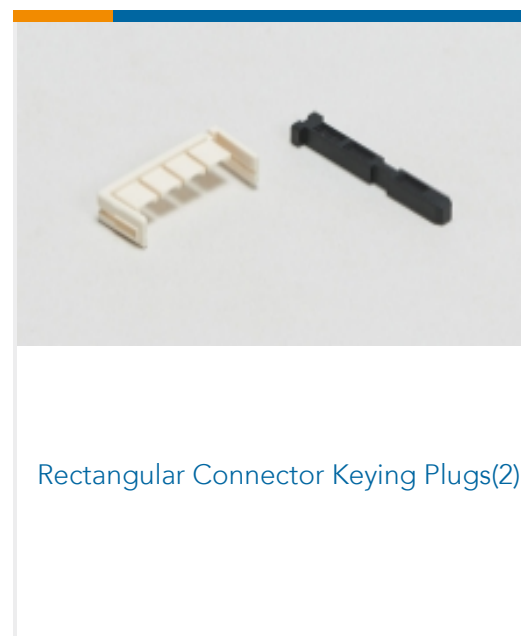
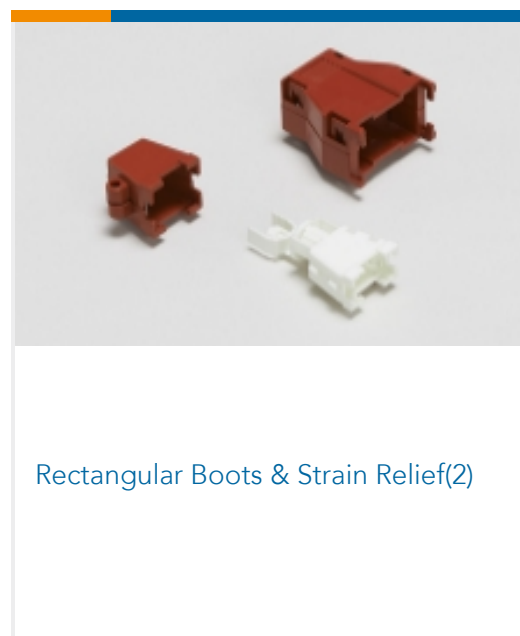
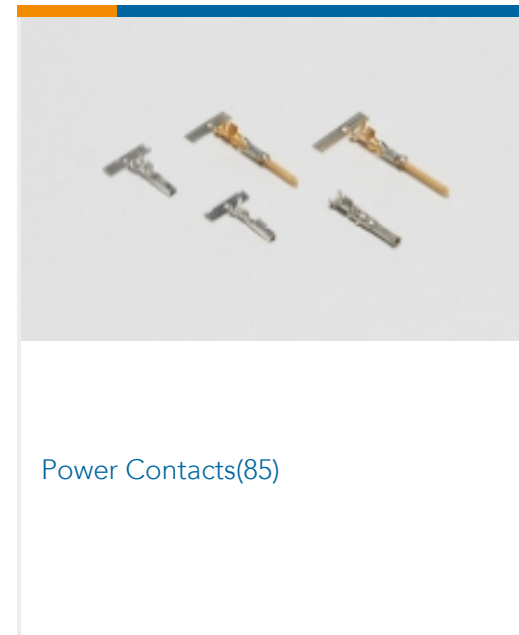
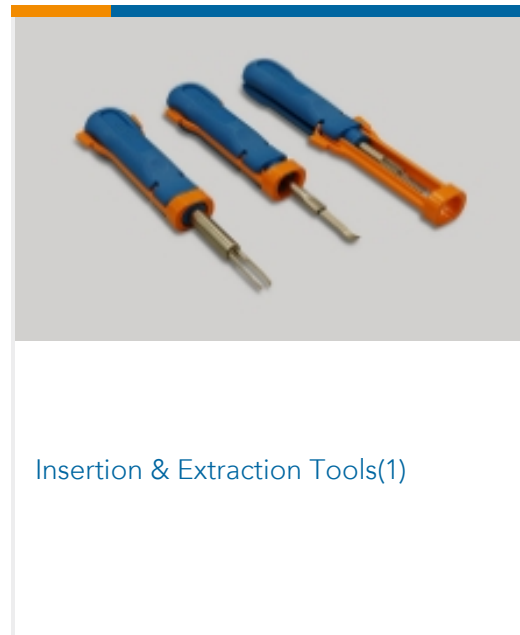
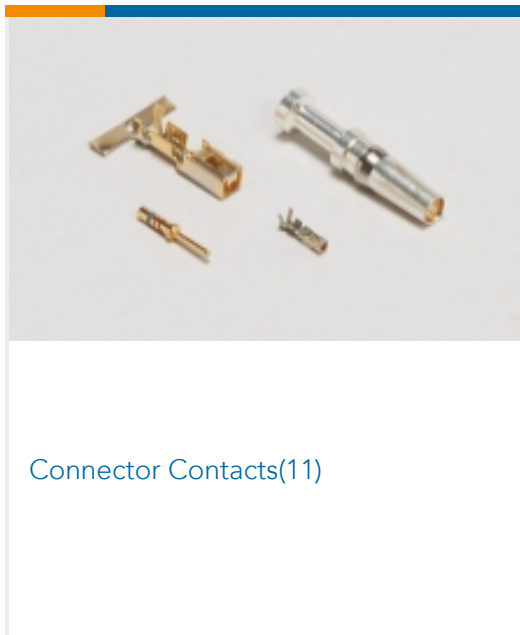

## Customers Also Bought

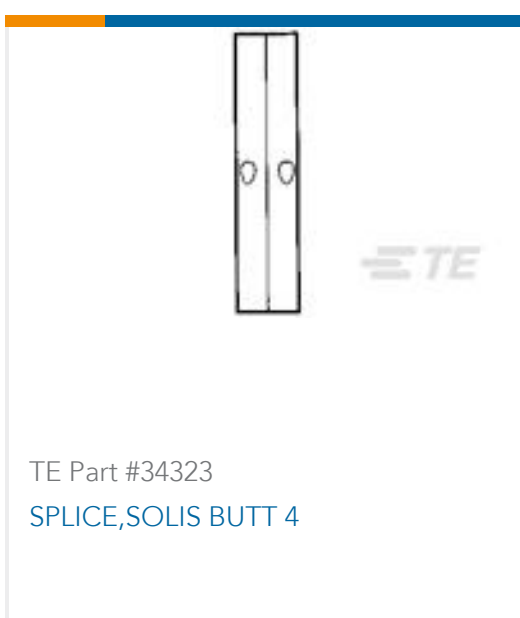

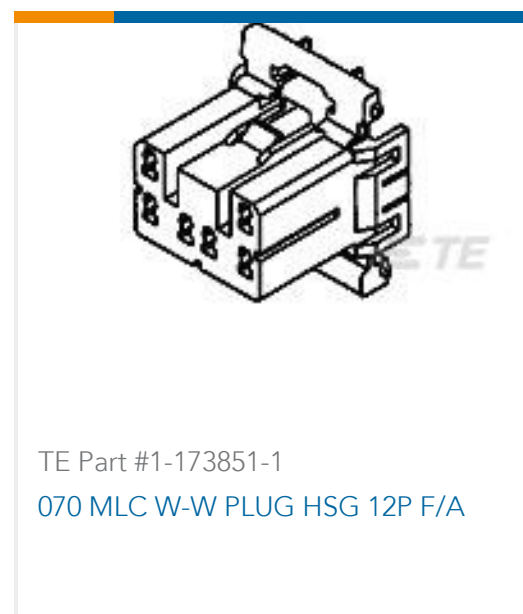

## Documents

### Product Drawings

#### MINI UNIVERSAL M-N-L CAP 15P

English

### CAD Files

#### 3D PDF

3D

#### Customer View Model

[ENG\\_CVM\\_CVM\\_1-172163-9\\_L.2d\\_dxf.zip](#)

English

#### Customer View Model

[ENG\\_CVM\\_CVM\\_1-172163-9\\_L.3d\\_igs.zip](#)

English

#### Customer View Model

[ENG\\_CVM\\_CVM\\_1-172163-9\\_L.3d\\_stp.zip](#)

English

By downloading the CAD file I accept and agree to the [Terms and Conditions](#) of use.

### Product Specifications

#### Application Specification

English

### Product Environmental Compliance

#### TE Material Declaration

English

### Instruction Sheets

#### Instruction Sheet (U.S.)



English

---

[Agency Approvals](#)

[Agency Approval Document](#)

English