

1-927771-1 ✓ ACTIVE

AMP | Junior Power Timer

TE Internal #: 1-927771-1

Automotive Terminals, Receptacle, Mating Tab Width 2.8 mm [.11 in], Tab Thickness .031 in [.8 mm], 20 – 17 AWG Wire Size, Junior Power Timer

[View on TE.com >](#)



Terminals & Splices > Automotive Terminals > TIMER, RECEPTACLE AND TAB



Terminal Type: **Receptacle**

Mating Tab Width: **2.8 mm [.11 in]**

Mating Tab Thickness: **.8 mm [.031 in]**

Terminal Transmits: **25 – 40 A (Power)**

Wire Size: **20 – 17 AWG**

[All TIMER, RECEPTACLE AND TAB \(346\)](#)

## Features

### Product Type Features

Receptacle Style	180°
Sealable	No
Primary Locking Feature	Locking Lance

### Contact Features

Contact Size	2.8mm
Contact Fabrication	Stamped & Formed
Typical Current Rating	30 A
Crimp Type	F-Crimp
Terminal Type	Receptacle
Mating Tab Width	2.8 mm[.11 in]
Mating Tab Thickness	.8 mm[.031 in]
Interface Plating	Gold (Au)
Contact Termination Area Plating Material	Tin (Sn)

### Termination Features

Termination Method to Wire & Cable	Crimp
Product Terminates To	Wire



### Dimensions

Wire Size	.5 – 1 mm <sup>2</sup>
Wire Size Search	17 AWG, 18 AWG, 19 AWG, 20 AWG
Wire Insulation Diameter	1.4 – 2.3 mm

### Usage Conditions

Insulation Option	Uninsulated
Operating Temperature (Max)	80 °C, 85 °C, 90 °C, 100 °C, 105 °C, 110 °C, 120 °C, 125 °C, 130 °C, 140 °C, 145 °C, 150 °C [176 °F][185 °F][194 °F][212 °F][221 °F][230 °F][248 °F][257 °F][266 °F][284 °F][293 °F][302 °F]
Operating Temperature Range	-40 – 150 °C[-40 – 302 °F]

### Operation/Application

Compatible With Wire Base Material	Copper
------------------------------------	--------

### Industry Standards

Agency/Standard	DIN 72 551 Part 6, DIN ISO 6722 part 3, IEC 664/664A (DIN VDE 0110)
-----------------	---

### Packaging Features

Packaging Method	Reel
Packaging Quantity	4000

### Other

Terminal Transmits	25 – 40 A (Power)
--------------------	-------------------

### Product Compliance

For compliance documentation, visit the product page on [TE.com](https://www.te.com)>

EU RoHS Directive 2011/65/EU	Compliant
EU ELV Directive 2000/53/EC	Compliant
China RoHS 2 Directive MIIT Order No 32, 2016	No Restricted Materials Above Threshold
EU REACH Regulation (EC) No. 1907/2006	Current ECHA Candidate List: JAN 2022 (223) Candidate List Declared Against: JAN 2022 (223) Does not contain REACH SVHC
Halogen Content	Low Halogen - Br, Cl, F, I < 900 ppm per homogenous material. Also BFR/CFR/PVC Free

Solder Process Capability

Not applicable for solder process capability

Product Compliance Disclaimer

This information is provided based on reasonable inquiry of our suppliers and represents our current actual knowledge based on the information they provided. This information is subject to change. The part numbers that TE has identified as EU RoHS compliant have a maximum concentration of 0.1% by weight in homogenous materials for lead, hexavalent chromium, mercury, PBB, PBDE, DBP, BBP, DEHP, DIBP, and 0.01% for cadmium, or qualify for an exemption to these limits as defined in the Annexes of Directive 2011/65/EU (RoHS2). Finished electrical and electronic equipment products will be CE marked as required by Directive 2011/65/EU. Components may not be CE marked. Additionally, the part numbers that TE has identified as EU ELV compliant have a maximum concentration of 0.1% by weight in homogenous materials for lead, hexavalent chromium, and mercury, and 0.01% for cadmium, or qualify for an exemption to these limits as defined in the Annexes of Directive 2000/53/EC (ELV). Regarding the REACH Regulation, the information TE provides on SVHC in articles for this part number is based on the latest European Chemicals Agency (ECHA) 'Guidance on requirements for substances in articles' posted at this URL: <https://echa.europa.eu/guidance-documents/guidance-on-reach>

## Compatible Parts



TE Part # 4-1579007-3  
EXTRACTION TOOL KIT



TE Part # 1-1579007-6  
EXTRACTION TOOL



TE Part # 2305570-1  
TERMINAL CUTTER, SIDE FEED



TE Part # CAT-T4827-CH8172  
TIMER, CONNECTOR HOUSING



**KIT**  
REPRESENTATION ONLY

TE Part # 7-2151092-7  
OCEAN\_2.0\_SPARE\_PART\_KIT-080F1100V



TE Part # 2151092-1  
OCEAN\_2.0\_APPLICATOR-S-080F1100V



TE Part # 2-1579007-3  
EXTRACTION TOOL



TE Part # 2-2151092-1  
OCEAN\_2.0\_APPLICATOR-S-080F1100V



TE Part # 2-2151092-2  
OCEAN\_2.0\_APPLICATOR-S-080F1100V



TE Part # 2-2266286-1  
OC-PA-S-FM-079SP110SP-LP-001-0199



TE Part # 2-2266286-2  
OC-PA-S-FA-079SP110SP-LP-001-0199



TE Part # 2151092-2  
OCEAN\_2.0\_APPLICATOR-S-080F1100V

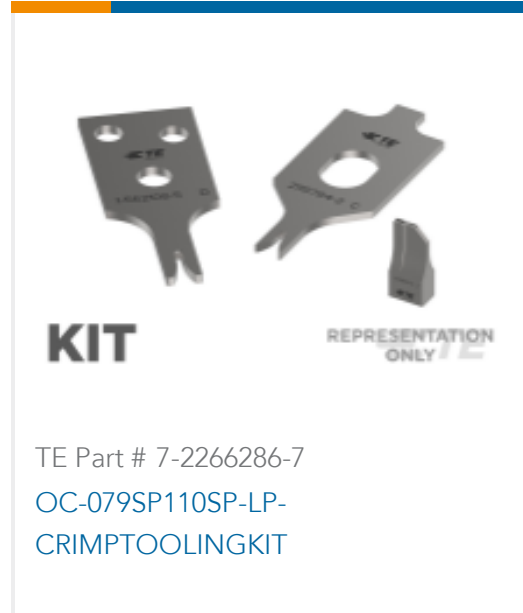

Also in the Series | Junior Power Timer

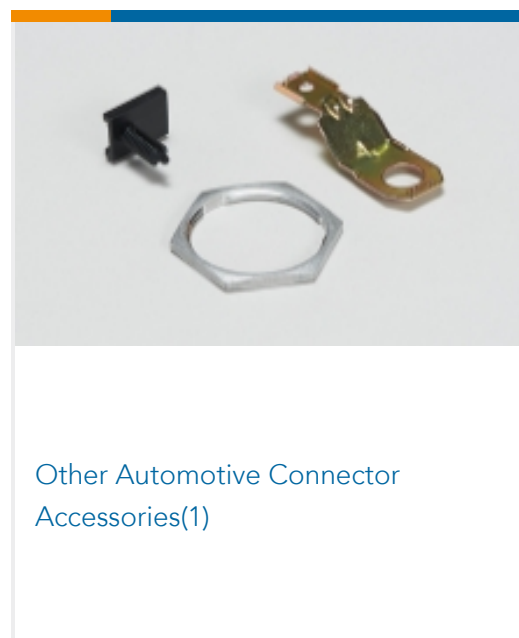
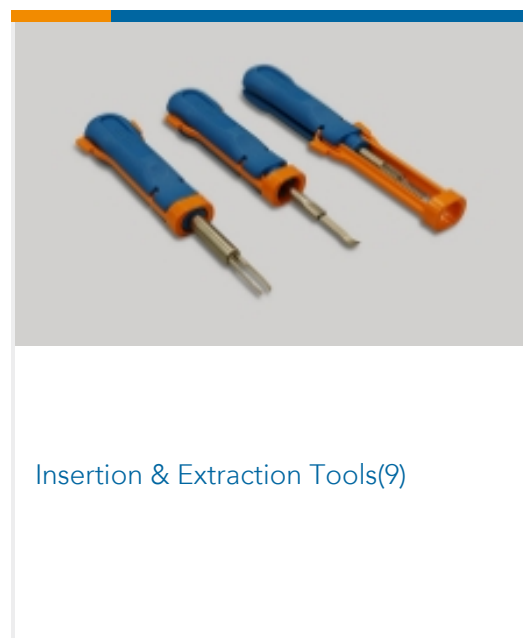
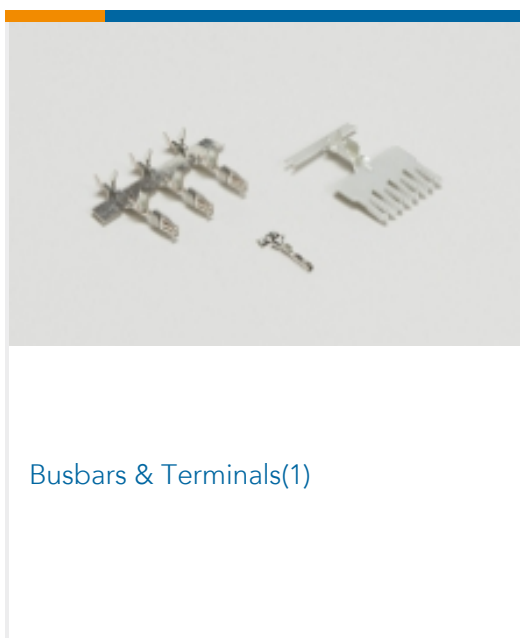
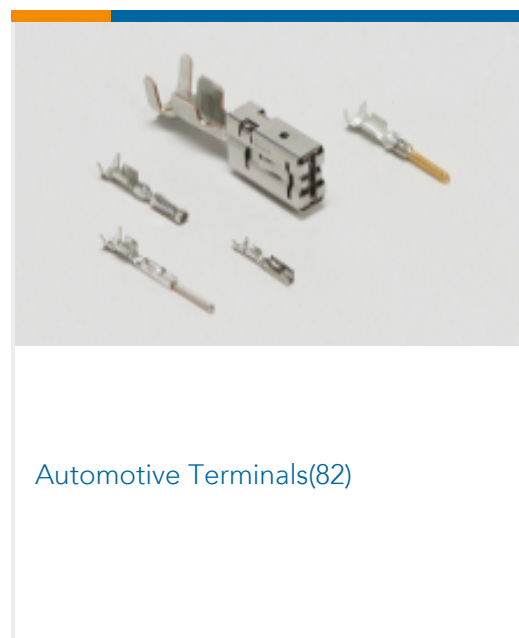
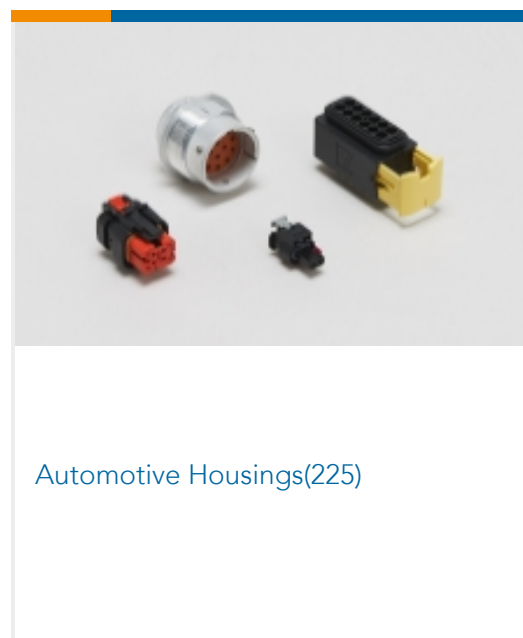
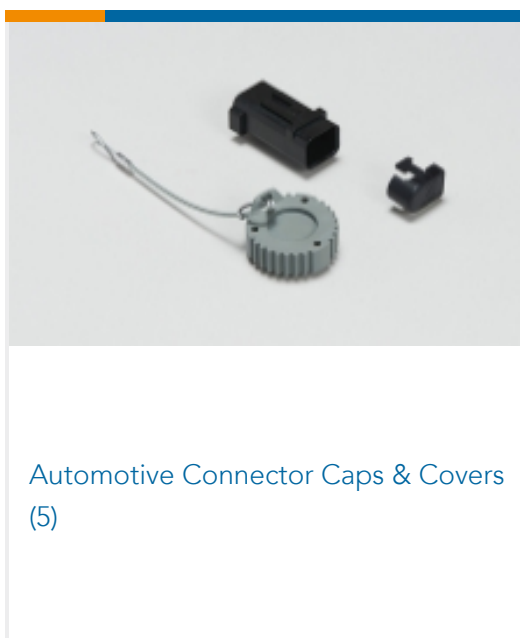

Customers Also Bought



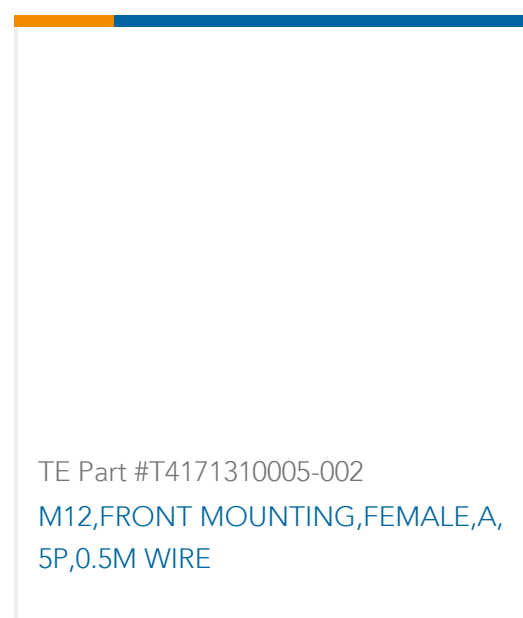
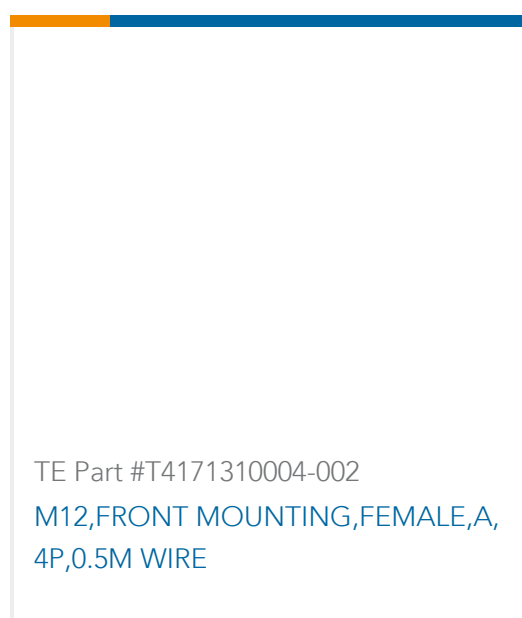
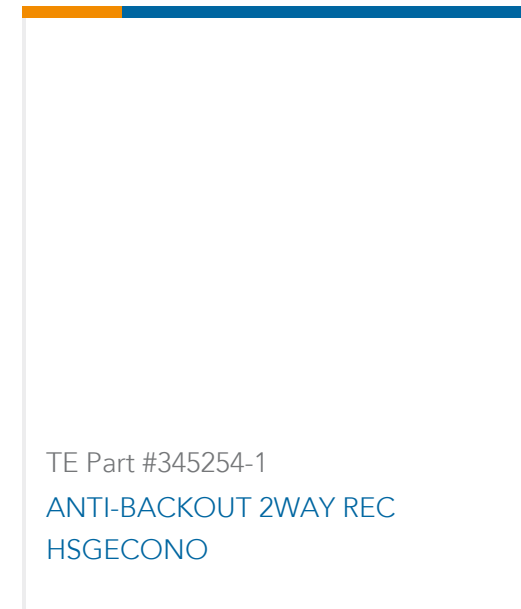
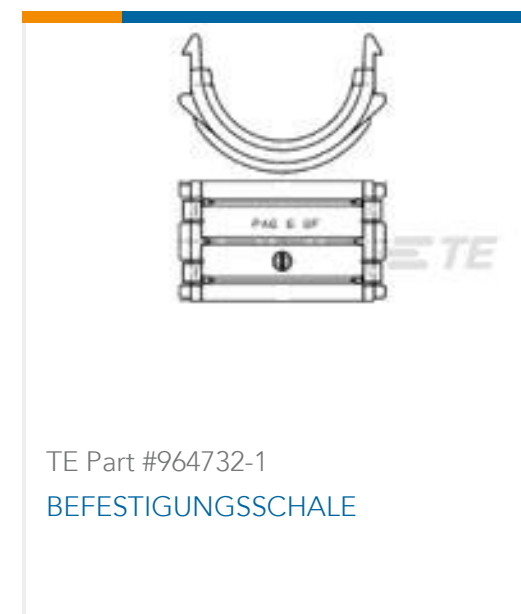

## Documents

### Product Drawings

[JPT REC 2.8 Contact SRC Au](#)

English

[JPT REC 2.8 Contact SRC Au](#)

English

### CAD Files

Customer View Model

[ENG\\_CVM\\_1-927771-1\\_A9.3d\\_igs.zip](#)

English

Customer View Model

[ENG\\_CVM\\_1-927771-1\\_A9.3d\\_stp.zip](#)

English

Customer View Model

[ENG\\_CVM\\_1-927771-1\\_A9.2d\\_dxf.zip](#)

English

[3D PDF](#)

English

By downloading the CAD file I accept and agree to the [Terms and Conditions](#) of use.



---

**Datasheets & Catalog Pages**

**Timer Interconnection System**

English

---

**Product Specifications**

**Application Specification**

English

**ER\*\*Sertissage des Clips Junior Power Timer sur Machine Automatique**

English

**Application Specification**

German

**Application Specification**

English