

1-480708-9 ✓ ACTIVE

MATE-N-LOK | Universal MATE-N-LOK

TE Internal #: 1-480708-9

Rectangular Power Connectors, Housing, Plug, Wire-to-Wire / Wire-to-Board, 12 Position, .25 in [6.35 mm] Centerline, Universal MATE-N-LOK

[View on TE.com >](#)



Connectors > Power Connectors > Rectangular Power > Rectangular Power Connectors

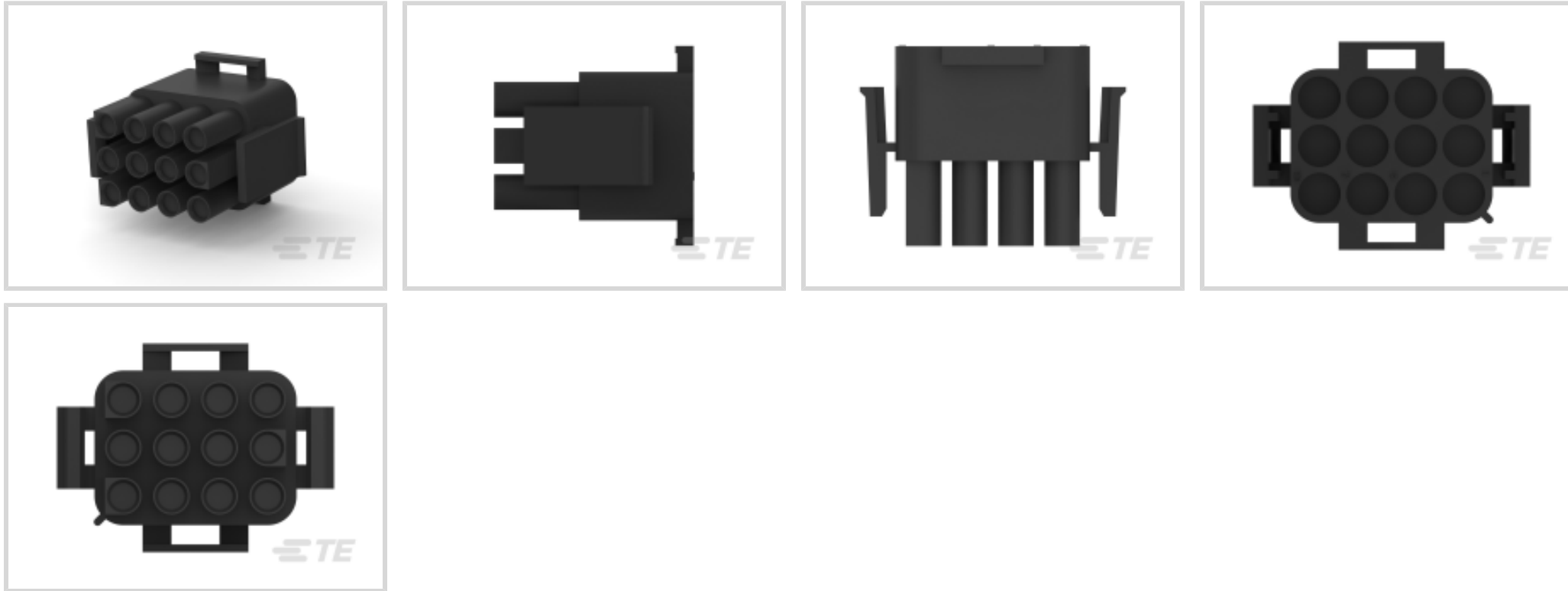

Rectangular Power Connector Type: **Housing**

Connector & Housing Type: **Plug**

Connector System: **Wire-to-Board, Wire-to-Wire**

Number of Positions: **12**

Centerline (Pitch): **6.35 mm [.25 in]**

Features

Product Type Features

Rectangular Power Connector Type	Housing
Connector & Housing Type	Plug
Connector System	Wire-to-Board, Wire-to-Wire
Sealable	No
Connector & Contact Terminates To	Wire & Cable

Configuration Features

Number of Positions	12
Number of Power Positions	0
Number of Signal Positions	0
Number of Rows	3

Electrical Characteristics

Operating Voltage	600 VAC
-------------------	---------

Contact Features

Contact Layout	Matrix
----------------	--------



Multiple Contact Types	Without
Contact Retention Within Housing	Without
Contact Type	Socket

Termination Features

Termination Method to Wire & Cable	Crimp
------------------------------------	-------

Mechanical Attachment

Connector Mounting Type	Cable Mount (Free-Hanging)
-------------------------	----------------------------

Housing Features

Centerline (Pitch)	6.35 mm [.25 in]
Housing Color	Black
Housing Material	Nylon

Dimensions

Row-to-Row Spacing	6.35 mm [.25 in]
Width	20.32 mm
Height	.03 – .09 in
Height	27.43 mm
Length	26.67 mm

Usage Conditions

Operating Temperature Range	-55 – 105 °C [-67 – 221 °F]
-----------------------------	-----------------------------

Operation/Application

Assembly Integration Feature	Without
Circuit Application	Power & Signal

Industry Standards

CSA Rating	Certified
UL Flammability Rating	UL 94V-2
Glow Wire Rating	Standard Part - Not Glow Wire
Agency/Standard Number	E28476
Agency/Standard	CSA, UL
UL Rating	Recognized
CSA File Number	LR7189
VDE Tested	Yes



Packaging Features

Packaging Method	Package
Packaging Quantity	1

Other

For Use With	Appropriate Universal MATE-N-LOK Cap or Header
--------------	--

Product Compliance

[For compliance documentation, visit the product page on TE.com>](#)







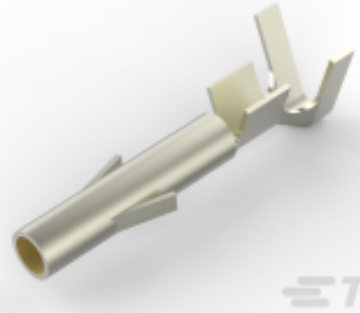
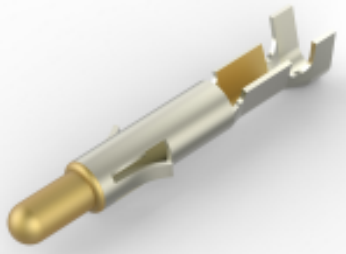
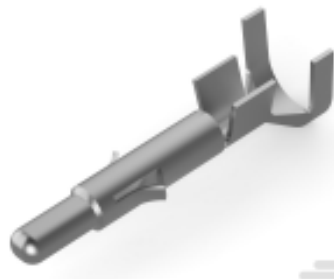
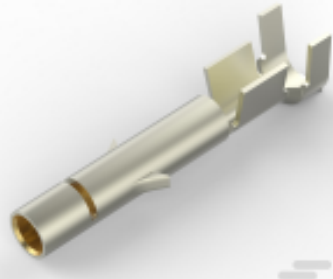

EU RoHS Directive 2011/65/EU	Compliant
EU ELV Directive 2000/53/EC	Compliant
China RoHS 2 Directive MIIT Order No 32, 2016	No Restricted Materials Above Threshold
EU REACH Regulation (EC) No. 1907/2006	Current ECHA Candidate List: JAN 2022 (223) Candidate List Declared Against: JAN 2021 (211) SVHC > Threshold: Not Yet Reviewed
Halogen Content	Not Low Halogen - contains Br or Cl > 900 ppm.
Solder Process Capability	Not applicable for solder process capability

Product Compliance Disclaimer

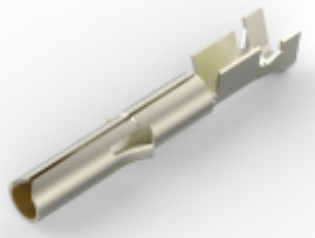
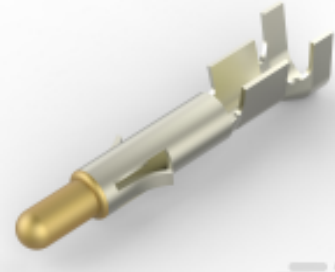
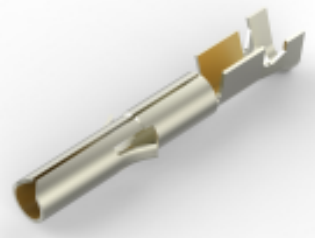
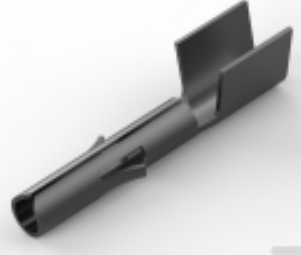
This information is provided based on reasonable inquiry of our suppliers and represents our current actual knowledge based on the information they provided. This information is subject to change. The part numbers that TE has identified as EU RoHS compliant have a maximum concentration of 0.1% by weight in homogenous materials for lead, hexavalent chromium, mercury, PBB, PBDE, DBP, BBP, DEHP, DIBP, and 0.01% for cadmium, or qualify for an exemption to these limits as defined in the Annexes of Directive 2011/65/EU (RoHS2). Finished electrical and electronic equipment products will be CE marked as required by Directive 2011/65/EU. Components may not be CE marked. Additionally, the part numbers that TE has identified as EU ELV compliant have a maximum concentration of 0.1% by weight in homogenous materials for lead, hexavalent chromium, and mercury, and 0.01% for cadmium, or qualify for an exemption to these limits as defined in the Annexes of Directive 2000/53/EC (ELV). Regarding the REACH Regulation, the information TE provides on SVHC in articles for this part number is based on the latest European Chemicals Agency (ECHA) 'Guidance on requirements for substances in articles' posted at this URL: <https://echa.europa.eu/guidance-documents/guidance-on-reach>

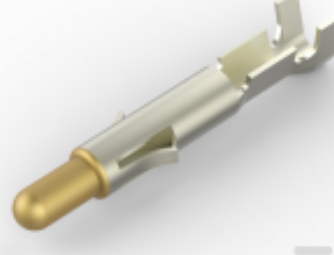
Compatible Parts

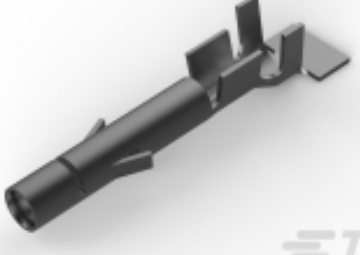
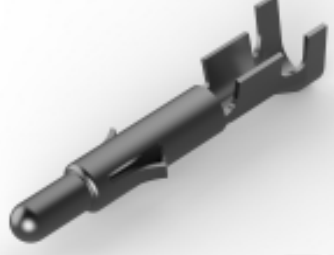
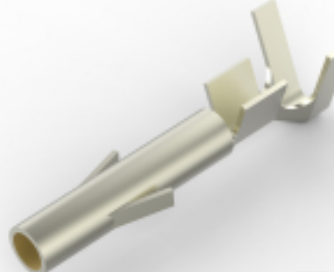
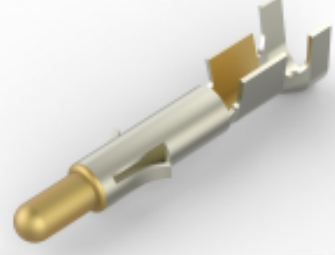
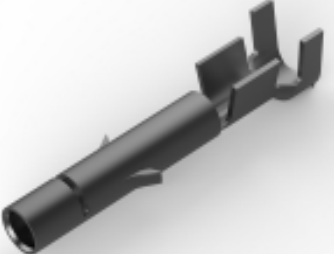

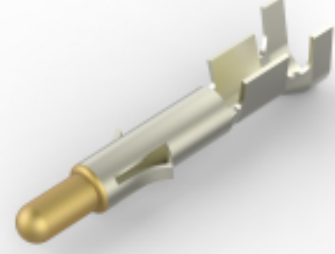
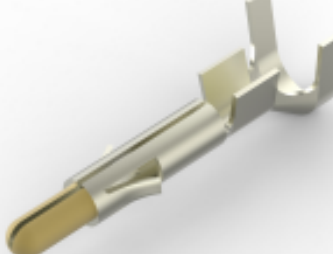
 <p>TE Part # 350551-6 UMNL SOK 20-14 AU/PHBZ L/P</p>	 <p>TE Part # 350690-2 UMNL PIN 24-18 AUBR L/P</p>	 <p>TE Part # 926902-3 UNIV-MNL SPLIT ST</p>	 <p>TE Part # 350550-7 UMNL SOK 20-14 AU/BR L/P</p>
 <p>TE Part # 350690-3 UMNL PIN 24-18 PTPPHBZ L/P</p>	 <p>TE Part # 350689-7 UMNL SOK 24-18 AUBR L/P</p>	 <p>TE Part # 350547-7 UMNL PIN 20-14 AUBR L/P</p>	 <p>TE Part # 350689-2 UMNL SOK 24-18 AUBR L/P</p>
 <p>TE Part # 640310-3 UMNL SOK 12-10 PTPPHBZ</p>	 <p>TE Part # 350689-3 UMNL SOK 24-18 PTPPHBZ L/P</p>	 <p>TE Part # 350690-7 UMNL PIN 24-18 AUBR L/P</p>	 <p>TE Part # 350689-1 UMNL SOK 24-18 PTPBR L/P</p>
 <p>TE Part # 926893-3 UNIV.M-N-L.SOCKET</p>	 <p>TE Part # 350547-3 UMNL PIN 20-14 PTPPHBZ L/P</p>	 <p>TE Part # 350551-7 UMNL SOK 20-14 AU/BR L/P</p>	 <p>TE Part # 350547-2 UMNL PIN 20-14 AUBR L/P</p>
 <p>TE Part # 350550-3 UMNL SOK 20-14 PTPPHBZ L/P</p>	 <p>TE Part # 770672-1 UMNL PIN 30-26 PTPBR L/P</p>	 <p>TE Part # 350547-6 UMNL PIN 20-14 AU/PHBZ L/P</p>	 <p>TE Part # 350538-7 UMNL PIN 20-14 AU/NI/BR</p>

Also in the Series | **Universal MATE-N-LOK**



Circular Power Connectors(2)



Connector Contacts(11)



Insertion & Extraction Tools(4)

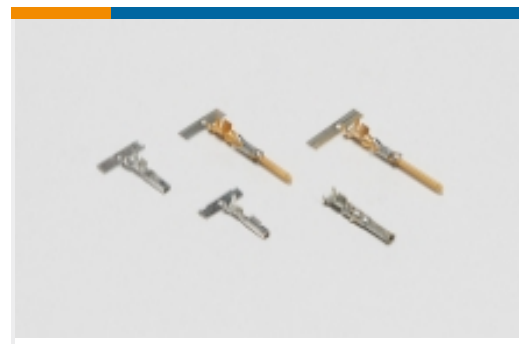

Power Contacts(207)

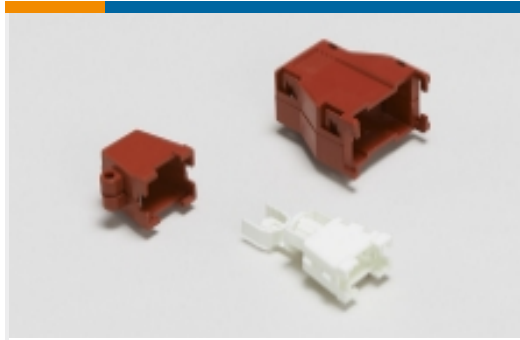

Rectangular Boots & Strain Relief(35)



Rectangular Connector Adapters(7)



Rectangular Connector Hardware(1)



Rectangular Connector Housings(2)



Rectangular Connector Keying Plugs(3)



Rectangular Connector Locking(4)



Rectangular Connector Seals(26)



Rectangular Power Connectors(729)

Customers Also Bought



TE Part #182651-1
CPC EMEA

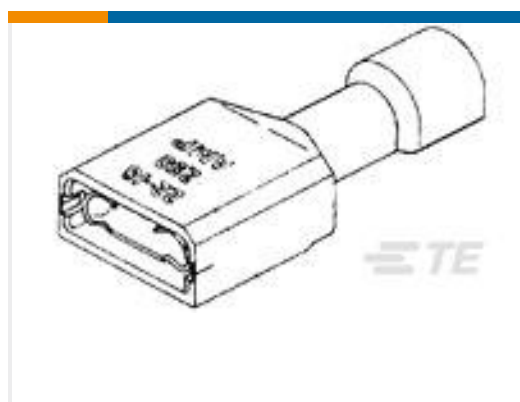

TE Part #3-520150-2
ULTRA-FAST 187 ASY REC 16-14 AWG
TPBR

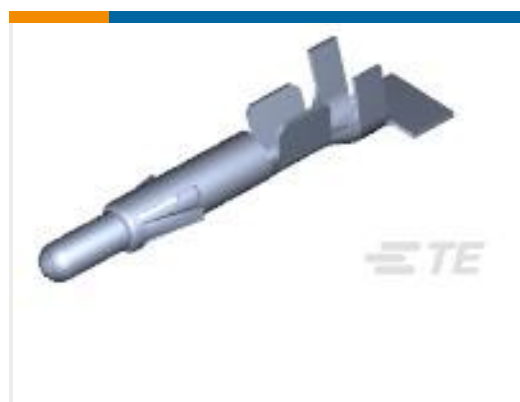

TE Part #350218-1
UMNL PIN 20-14 .0126PTPBR



TE Part #T1310100120-000
H10B-TS-RO-M20



TE Part #HD36-18-8SN
DEUTSCH HD30 HOUSINGS



TE Part #66740-2
TYPE XII FEMALE CONT (L.P.)



TE Part #T2120100219-000
ZGG-10DSTK,1-7,2-8,3-9,4-6,5-10



TE Part #T2120100220-000
ZGGP-H10BSK 1-7/2-8/3-9/4-6/5-10

Documents



Product Drawings

12P UMNL PLUG HSG BLK

English

CAD Files

3D PDF

English

Customer View Model

[ENG_CVM_1-480708-9_AN.2d_dxf.zip](#)

English

Customer View Model

[ENG_CVM_1-480708-9_AN.3d_igs.zip](#)

English

Customer View Model

[ENG_CVM_1-480708-9_AN.3d_stp.zip](#)

English

3D PDF

3D

Customer View Model

[ENG_CVM_CVM_1-480708-9_CC.2d_dxf.zip](#)

English

Customer View Model

[ENG_CVM_CVM_1-480708-9_CC.3d_igs.zip](#)

English

Customer View Model

[ENG_CVM_CVM_1-480708-9_CC.3d_stp.zip](#)

English

By downloading the CAD file I accept and agree to the [Terms and Conditions](#) of use.

Datasheets & Catalog Pages

SOFT_SHELL_PIN_SOCKET_CONNECTORS_STANDARD_DENSITY

English

Product Specifications

Universal MATE-N-LOK Connector

English

Product Environmental Compliance

TE Material Declaration

English

Instruction Sheets

Instruction Sheet (U.S.)

English

Instruction Sheet (U.S.)

English



[Agency Approvals](#)

[CSA Certificate](#)

English