

THIS DRAWING IS UNPUBLISHED.

RELEASED FOR PUBLICATION

20

© COPYRIGHT 20 BY -

ALL RIGHTS RESERVED.

REVISIONS

P	LTR	DESCRIPTION	DATE	DWN	APVD
	A	REVISED (ECR-07-007867)	24.APR.'07	IS	JK
	A1	REVISED (ECR-15-010973)	23.JUL.'15	JM	HG
	A2	REVISED (ECR-16-005448)	30.MAY.'16	JS	KT
	A3	REVISED (ECR-18-000247)	21.DEC.'17	JS	YJ

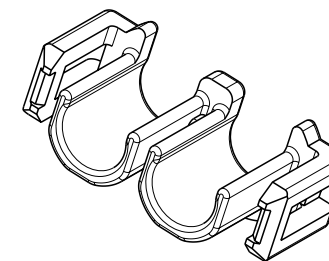
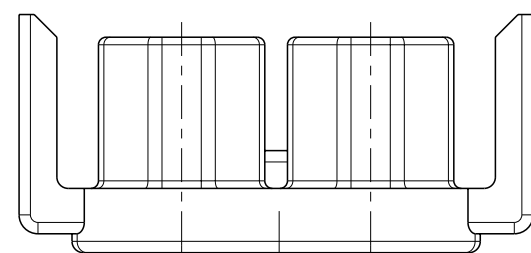
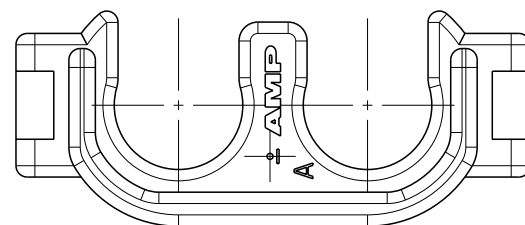
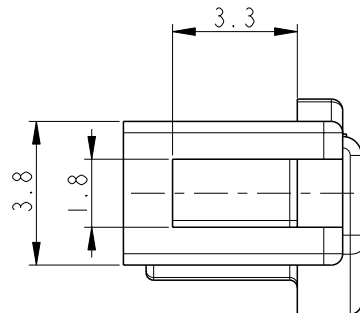
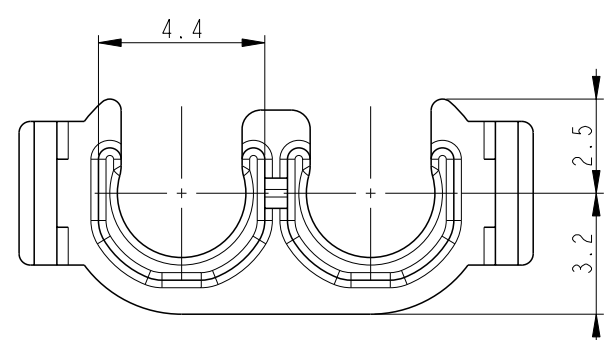
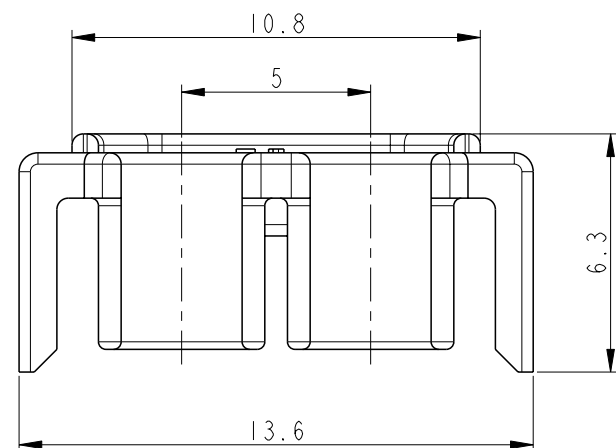

SCALE 3:1

DBL CODING	TYPE	SCALE	APPLICABLE PLUG
TYPE A	(Left View)	SCALE 4:1	A3 - APPLICABLE PLUG : 936059
	(Right View)	SCALE 4:1	
TYPE B	(Left View)	SCALE 4:1	A3 - APPLICABLE PLUG : 2005388
	(Right View)	SCALE 4:1	

NOTE

- 1. APPLICABLE PLUG HSG P/N : 936059, 2005388
- 2. GENERAL TOLERANCE : ±0.3, ±3°

TYPE	COLOR	MATERIAL	PART NO.
B	GRAY	PBT	1-936103-3
A	GRAY	PBT	0-936103-3
A	BLACK	PBT	0-936103-2
A	YELLOW	PBT	0-936103-1

THIS DRAWING IS A CONTROLLED DOCUMENT.

DIMENSIONS: mm

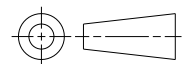

TOLERANCES UNLESS OTHERWISE SPECIFIED:

0 PLC	±
1 PLC	±
2 PLC	±
3 PLC	±
4 PLC	±
ANGLES	±
FINISH	-

MATERIAL SEE TABLE

DWN	JS KIM
CHK	DG JEONG
APVD	YJ YOUN
PRODUCT SPEC	-
APPLICATION SPEC	-
WEIGHT	-



NAME DBL HSG FOR 2.8mm SEALED 2P PLUG ASSY

SIZE	CAGE CODE	DRAWING NO	RESTRICTED TO
A3	00779	C-936103	-

CUSTOMER DRAWING SCALE 5:1 SHEET 1 OF 1 REV A3