



AMP | Timer Connector System

TE Internal #: 969028-2

Automotive Terminals, Tab, Mating Tab Width 1.6 mm [.063 in], Tab Thickness .024 in [.6 mm], 24 – 20 AWG Wire Size, Timer Connector System

[View on TE.com >](#)

Terminals & Splices > Automotive Terminals > TIMER, RECEPTACLE AND TAB



Terminal Type: **Tab**

Mating Tab Width: **1.6 mm [.063 in]**

Mating Tab Thickness: **.6 mm [.024 in]**

Terminal Transmits: **0 – 24 A (Low Power)**

Wire Size: **24 – 20 AWG**

[All TIMER, RECEPTACLE AND TAB \(346\)](#)

Features

Product Type Features

Receptacle Style	180°
Sealable	Yes
Primary Locking Feature	Locking Lance

Body Features

Terminal Seal Type	Single Wire Seal (SWS)
--------------------	------------------------

Contact Features

Typical Current Rating	10 A
Crimp Type	F-Crimp
Terminal Type	Tab
Mating Tab Width	1.6 mm [.063 in]
Mating Tab Thickness	.6 mm [.024 in]
Interface Plating	Tin (Sn)
Contact Termination Area Plating Material	Tin (Sn)

Termination Features

Termination Method to Wire & Cable	Crimp
Product Terminates To	Wire



Dimensions

Wire Size	.2 – .5 mm ²
Wire Size Search	20 AWG, 21 AWG, 22 AWG, 23 AWG, 24 AWG
Wire Insulation Diameter	1.15 – 1.6 mm [.045 – .063 in]

Usage Conditions

Insulation Option	Uninsulated
Operating Temperature (Max)	80 °C, 85 °C, 90 °C, 100 °C, 105 °C, 110 °C, 120 °C [176 °F] [185 °F] [194 °F] [212 °F] [221 °F] [230 °F] [248 °F]
Operating Temperature Range	-40 – 120 °C [-40 – 248 °F]

Operation/Application

Compatible With Wire Base Material	Copper
------------------------------------	--------

Industry Standards

Agency/Standard	DIN 72 551 Part 5 and 6
-----------------	-------------------------

Packaging Features

Packaging Method	Reel
Packaging Quantity	4000

Other

Terminal Transmits	0 – 24 A (Low Power)
--------------------	----------------------

Product Compliance

[For compliance documentation, visit the product page on TE.com>](#)

EU RoHS Directive 2011/65/EU	Compliant
EU ELV Directive 2000/53/EC	Compliant
China RoHS 2 Directive MIIT Order No 32, 2016	No Restricted Materials Above Threshold
EU REACH Regulation (EC) No. 1907/2006	Current ECHA Candidate List: JAN 2022 (223) Candidate List Declared Against: JAN 2022 (223) Does not contain REACH SVHC
Halogen Content	Low Halogen - Br, Cl, F, I < 900 ppm per homogenous material. Also BFR/CFR/PVC Free
Solder Process Capability	Not applicable for solder process capability

Product Compliance Disclaimer

This information is provided based on reasonable inquiry of our suppliers and represents our current actual knowledge based on the information they provided. This information is subject to change. The part numbers that TE has identified as EU RoHS compliant have a maximum concentration of 0.1% by weight in homogenous materials for lead, hexavalent chromium, mercury, PBB, PBDE, DBP, BBP, DEHP, DIBP, and 0.01% for cadmium, or qualify for an exemption to these limits as defined in the Annexes of Directive 2011/65/EU (RoHS2). Finished electrical and electronic equipment products will be CE marked as required by Directive 2011/65/EU. Components may not be CE marked. Additionally, the part numbers that TE has identified as EU ELV compliant have a maximum concentration of 0.1% by weight in homogenous materials for lead, hexavalent chromium, and mercury, and 0.01% for cadmium, or qualify for an exemption to these limits as defined in the Annexes of Directive 2000/53/EC (ELV). Regarding the REACH Regulation, the information TE provides on SVHC in articles for this part number is based on the latest European Chemicals Agency (ECHA) 'Guidance on requirements for substances in articles' posted at this URL: <https://echa.europa.eu/guidance-documents/guidance-on-reach>

Compatible Parts

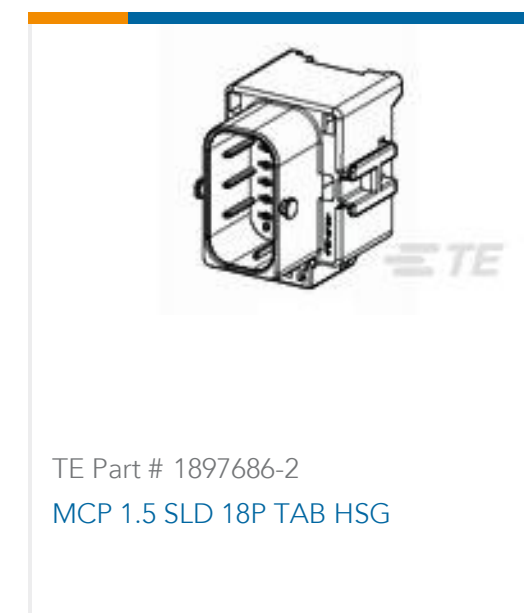
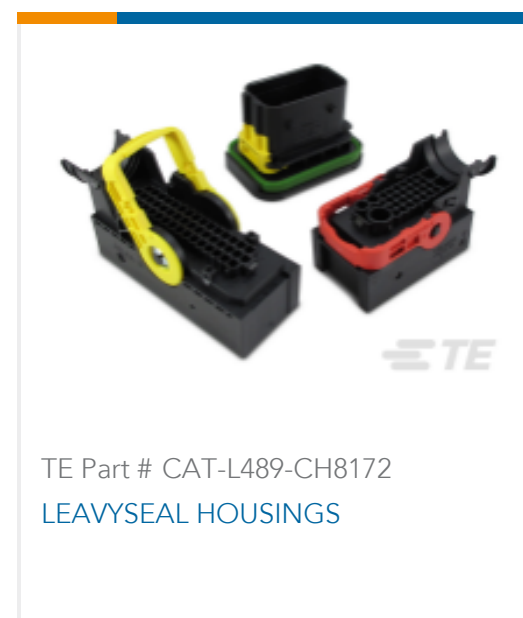



TE Part # 2-1703843-2
3POS,TAB 1.6X0.6,TAB HSG,ASSY,



TE Part # 2-2151056-1
OCEAN_2.0_APPLICATOR-S-062F130O



TE Part # 2-2151056-2
OCEAN_2.0_APPLICATOR-S-062F130O



TE Part # 2151056-1
OCEAN_2.0_APPLICATOR-S-062F130O



TE Part # 2151056-2
OCEAN_2.0_APPLICATOR-S-062F130O



TE Part # 2324104-1
6 POSITIONS E.G.R. WIRE TO WIRE HSG ASSY



TE Part # 3-1670730-2
3POS,TAB 1.5X0.63 TAB HSG MID POS CLOSED



TE Part # 3-1703843-2
3POS,TAB 1.6X0.6,TAB HSG,ASSY,

Also in the Series | **Timer Connector System**



Automotive Connector Caps & Covers (11)

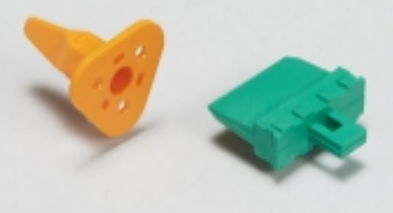

Automotive Connector Locks & Position Assurance(16)



Automotive Housings(219)



Automotive Seals & Cavity Plugs(31)

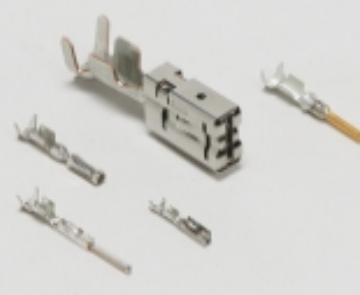

Automotive Terminals(140)

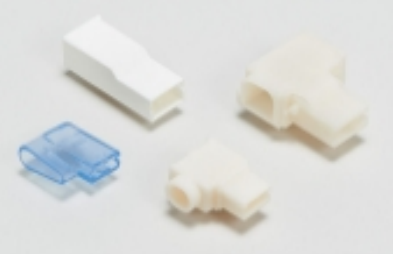

Crimp Terminal Housings(13)



Insertion & Extraction Tools(20)



Other Automotive Connector Accessories(1)



PCB Headers & Receptacles(78)



Quick Disconnects(4)

Customers Also Bought

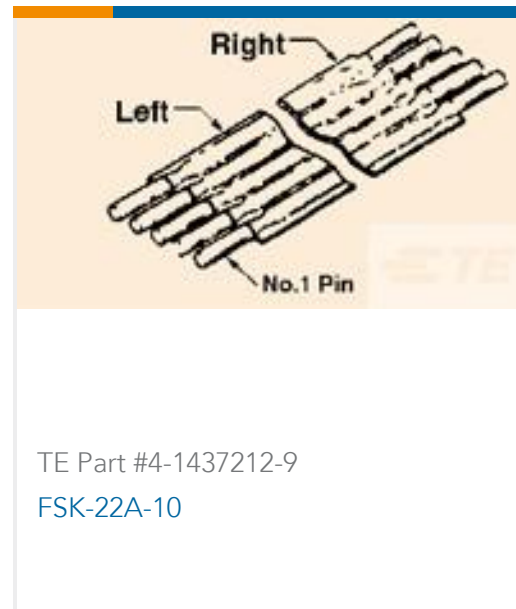
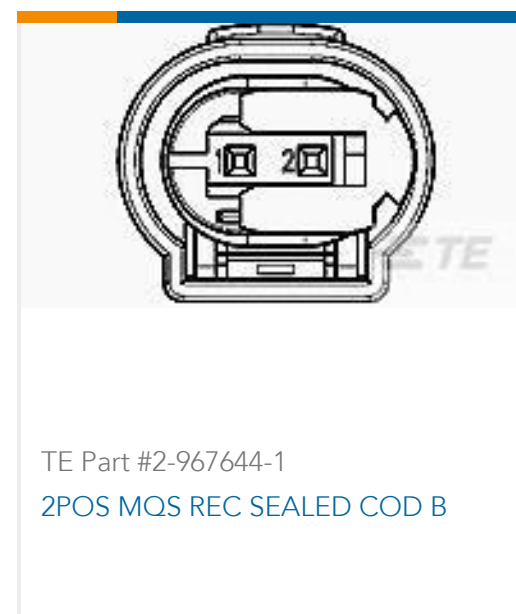
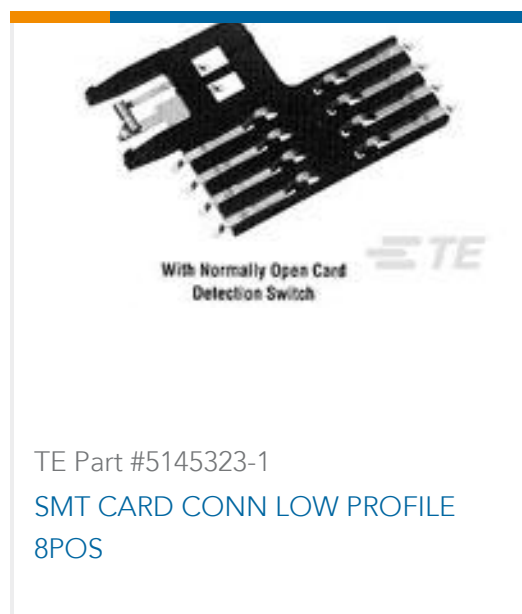

Documents

Product Drawings

[TAB A 1.6x0.6 CONTACT CF SWS Sn](#)

English

[TAB A 1.6x0.6 CONTACT CF SWS Sn](#)

English

CAD Files

[3D PDF](#)

3D

Customer View Model

[ENG_CVM_CVM_969028-2_D.2d_dxf.zip](#)

English

Customer View Model

[ENG_CVM_CVM_969028-2_D.3d_igs.zip](#)

English

Customer View Model

[ENG_CVM_CVM_969028-2_D.3d_stp.zip](#)

English



Datasheets & Catalog Pages

Timer Interconnection System

English

HDSCS Catalog

English

CONNECTOR SELECTOR

English

Product Specifications

Application Specification

German

Application Specification

English

Application Specification

English

Product Environmental Compliance

Product Compliance

English

Product Compliance

English