

963216-1 ✓ ACTIVE

AMP | Timer Connector System

TE Internal #: 963216-1

Automotive Seals & Cavity Plugs, Facial Seal, Silicone, Natural,  
Timer Connector System

[View on TE.com >](#)



Connectors > Automotive Connectors > Seals & Cavity Plugs

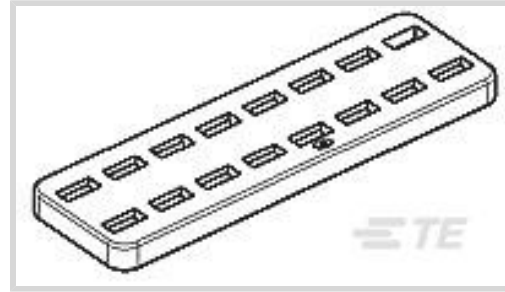

Connector Seal Type: **Facial Seal**

Seal Material: **Silicone**

Contains Lubricant: **No**

Primary Product Color: **Natural**

## Features

### Product Type Features

Connector Seal Type	Facial Seal
---------------------	-------------

### Body Features

Seal Material	Silicone
Primary Product Color	Natural

### Packaging Features

Packaging Quantity	1000
Packaging Method	Bag

### Other

Contains Lubricant	No
--------------------	----

## Product Compliance

[For compliance documentation, visit the product page on TE.com>](#)

EU RoHS Directive 2011/65/EU	Compliant
EU ELV Directive 2000/53/EC	Compliant
China RoHS 2 Directive MIIT Order No 32, 2016	No Restricted Materials Above Threshold
EU REACH Regulation (EC) No. 1907/2006	Current ECHA Candidate List: JAN 2022 (223) Candidate List Declared Against: JAN 2022 (223) Does not contain REACH SVHC
Halogen Content	Low Halogen - Br, Cl, F, I < 900 ppm per

homogenous material. Also BFR/CFR/PVC Free

Solder Process Capability

Not applicable for solder process capability

Product Compliance Disclaimer

This information is provided based on reasonable inquiry of our suppliers and represents our current actual knowledge based on the information they provided. This information is subject to change. The part numbers that TE has identified as EU RoHS compliant have a maximum concentration of 0.1% by weight in homogenous materials for lead, hexavalent chromium, mercury, PBB, PBDE, DBP, BBP, DEHP, DIBP, and 0.01% for cadmium, or qualify for an exemption to these limits as defined in the Annexes of Directive 2011/65/EU (RoHS2). Finished electrical and electronic equipment products will be CE marked as required by Directive 2011/65/EU. Components may not be CE marked. Additionally, the part numbers that TE has identified as EU ELV compliant have a maximum concentration of 0.1% by weight in homogenous materials for lead, hexavalent chromium, and mercury, and 0.01% for cadmium, or qualify for an exemption to these limits as defined in the Annexes of Directive 2000/53/EC (ELV). Regarding the REACH Regulation, the information TE provides on SVHC in articles for this part number is based on the latest European Chemicals Agency (ECHA) 'Guidance on requirements for substances in articles' posted at this URL: <https://echa.europa.eu/guidance-documents/guidance-on-reach>

### Compatible Parts



TE Part # CAT-LMPH9507  
LOW & MEDIUM POWER HEADER



TE Part # CAT-T4827-CH8172  
TIMER, CONNECTOR HOUSING



TE Part # 3-963215-1  
16P STIFTWANNE 3MM



TE Part # 5-963215-1  
16P STIFTWANNE 3MM

### Also in the Series | Timer Connector System



Automotive Connector Caps & Covers (11)

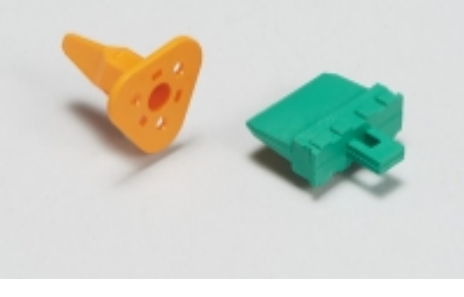

Automotive Connector Locks & Position Assurance(16)



Automotive Housings(219)



Automotive Seals & Cavity Plugs(31)

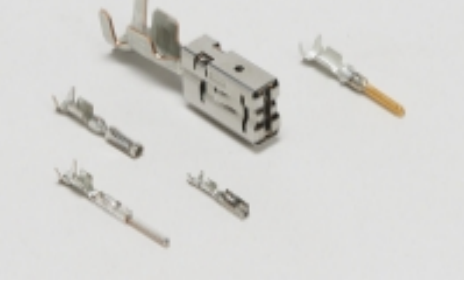

Automotive Terminals(140)

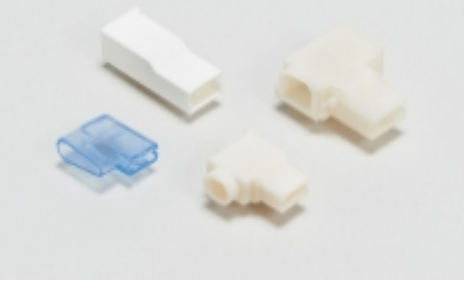

Crimp Terminal Housings(13)



Insertion & Extraction Tools(20)



Other Automotive Connector Accessories(1)



PCB Headers & Receptacles(78)



Quick Disconnects(4)

## Customers Also Bought



TE Part #2-1630012-8  
HSC150 22R 5%



TE Part #3-1676481-0  
CPF 0603 82R 0.1% 25PPM 1K RL



TE Part #1-963217-1  
16 J-P-T GEH KOMPL



TE Part #2-1355842-1  
MESSERLEI3MM16P270

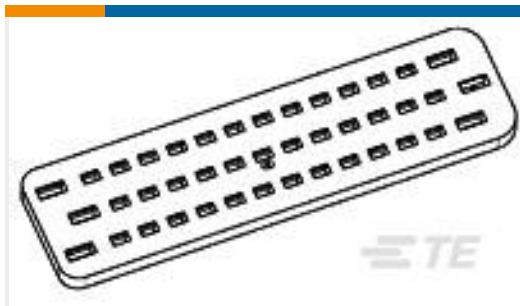

TE Part #963225-1  
DICHTUNG F 42P GEH



TE Part #1-968050-1  
SPECIAL TERMINAL 11-10 AWG PTPB



TE Part #556883-1  
CONT,AMPINRGY WTB,LS PC,14-18

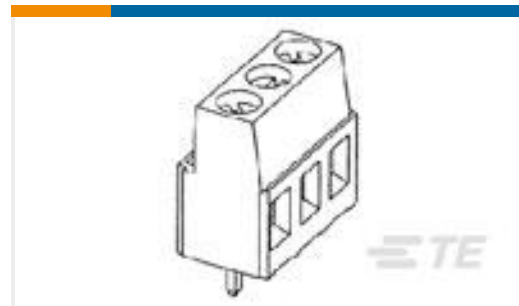

TE Part #2-796683-4  
TERMI-BLOK PCB MOUNT 90 24P.

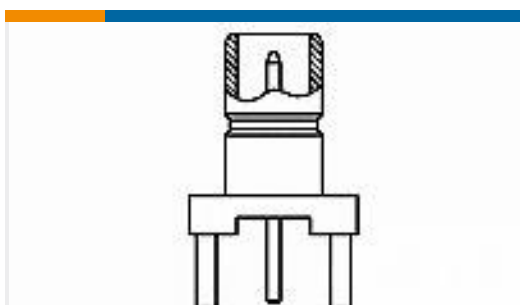

TE Part #415504-2  
JACK,PCB,MINI-SMB VERT 75 OHM

## Documents

### Product Drawings

DICHTUNG

English

### CAD Files

Customer View Model

ENG\_CVM\_963216-1\_D.3d\_igs.zip

English

Customer View Model



[ENG\\_CVM\\_963216-1\\_D.3d\\_stp.zip](#)

English

**Customer View Model**

[ENG\\_CVM\\_963216-1\\_D.2d\\_dxf.zip](#)

English

**3D PDF**

English

By downloading the CAD file I accept and agree to the [Terms and Conditions](#) of use.

---

### Product Environmental Compliance

**Product Compliance**

English

**Product Compliance**

English

---

### Instruction Sheets

**CONNECTEURS JPT ETANCHES A ETRIER POUR CONNEXIONS FIL A FIL PRECONISAT**

English

**Instruction Sheet (non U.S.)**

English