

964324-1 ✓ ACTIVE

AMP | Standard Power Timer

TE Internal #: 964324-1

Automotive Terminals, Receptacle, Mating Tab Width 6.3 mm / 5.8 mm [.248 in / .228 in], Tab Thickness .031 in [.8 mm], Standard Power Timer

[View on TE.com >](#)



Terminals & Splices > Automotive Terminals > TIMER, RECEPTACLE AND TAB



Terminal Type: **Receptacle**

Mating Tab Width: 5.8 mm, 6.3 mm [.228 in, .248 in]

Mating Tab Thickness: .8 mm [.031 in]

Terminal Transmits: 25 – 40 A (Power)

Wire Size: 20 – 17 AWG

[All TIMER, RECEPTACLE AND TAB \(346\)](#)

## Features

### Product Type Features

Sealable	No
Primary Locking Feature	Locking Lance

### Contact Features

Typical Current Rating	40 A
Crimp Type	F-Crimp
Terminal Type	Receptacle
Mating Tab Width	5.8 mm, 6.3 mm [.228 in][.248 in]
Mating Tab Thickness	.8 mm [.031 in]
Interface Plating	Tin (Sn)
Contact Termination Area Plating Material	Tin (Sn)

### Termination Features

Termination Method to Wire & Cable	Crimp
Product Terminates To	Wire

### Dimensions

Wire Size	.5 – 1 mm <sup>2</sup>
Wire Size Search	17 AWG, 18 AWG, 19 AWG, 20 AWG



Wire Insulation Diameter	1.4 – 2.17 mm [.055 – .083 in]
--------------------------	--------------------------------

### Usage Conditions

Insulation Option	Uninsulated
Operating Temperature (Max)	80 °C, 85 °C, 90 °C, 100 °C, 105 °C, 110 °C, 120 °C, 125 °C, 130 °C [176 °F][185 °F][194 °F][212 °F][221 °F][230 °F][248 °F][257 °F][266 °F]
Operating Temperature Range	-40 – 130 °C [-40 – 266 °F]

### Operation/Application

Compatible With Wire Base Material	Copper
------------------------------------	--------

### Industry Standards

Agency/Standard	IEC 664/664A (DIN VDE 0110)
-----------------	-----------------------------

### Packaging Features

Packaging Method	Reel
Packaging Quantity	2100

### Other

Terminal Transmits	25 – 40 A (Power)
--------------------	-------------------

## Product Compliance

[For compliance documentation, visit the product page on TE.com>](#)

EU RoHS Directive 2011/65/EU	Compliant
EU ELV Directive 2000/53/EC	Compliant
China RoHS 2 Directive MIIT Order No 32, 2016	No Restricted Materials Above Threshold
EU REACH Regulation (EC) No. 1907/2006	Current ECHA Candidate List: JAN 2022 (223) Candidate List Declared Against: JAN 2022 (223) Does not contain REACH SVHC
Halogen Content	Low Halogen - Br, Cl, F, I < 900 ppm per homogenous material. Also BFR/CFR/PVC Free
Solder Process Capability	Not applicable for solder process capability

#### Product Compliance Disclaimer

This information is provided based on reasonable inquiry of our suppliers and represents our current actual knowledge based on the information they provided. This information is subject to change. The part numbers that TE has identified as EU RoHS compliant have a maximum concentration of 0.1% by weight in homogenous materials for lead, hexavalent

chromium, mercury, PBB, PBDE, DBP, BBP, DEHP, DIBP, and 0.01% for cadmium, or qualify for an exemption to these limits as defined in the Annexes of Directive 2011/65/EU (RoHS2). Finished electrical and electronic equipment products will be CE marked as required by Directive 2011/65/EU. Components may not be CE marked. Additionally, the part numbers that TE has identified as EU ELV compliant have a maximum concentration of 0.1% by weight in homogenous materials for lead, hexavalent chromium, and mercury, and 0.01% for cadmium, or qualify for an exemption to these limits as defined in the Annexes of Directive 2000/53/EC (ELV). Regarding the REACH Regulation, the information TE provides on SVHC in articles for this part number is based on the latest European Chemicals Agency (ECHA) 'Guidance on requirements for substances in articles' posted at this URL: <https://echa.europa.eu/guidance-documents/guidance-on-reach>

## Compatible Parts



TE Part # 4-1579007-3  
EXTRACTION TOOL KIT



TE Part # 1-1579007-6  
EXTRACTION TOOL



TE Part # 2305570-1  
TERMINAL CUTTER, SIDE FEED



TE Part # CAT-T4827-CH8172  
TIMER, CONNECTOR HOUSING



TE Part # 2-2151190-1  
OCEAN\_2.0\_APPLICATOR-S-080F110OV



TE Part # 2-2151190-2  
OCEAN\_2.0\_APPLICATOR-S-080F110OV



TE Part # 2151190-1  
OCEAN\_2.0\_APPLICATOR-S-080F110OV



TE Part # 2151190-2  
OCEAN\_2.0\_APPLICATOR-S-080F110OV



TE Part # 7-2151190-1  
OCEAN\_2.0\_APPLICATOR-S-080F110OV



TE Part # 7-2151190-2  
OCEAN\_2.0\_APPLICATOR-S-080F110OV



TE Part # 7-2151190-7  
OCEAN\_2.0\_SPARE\_PART\_KIT-080F110OV



TE Part # 1393446-1  
V23540M6005Z 20=5 POL FL KONT



TE Part # 1393446-3  
V23540M6005Z 21=5 POL FL KONT

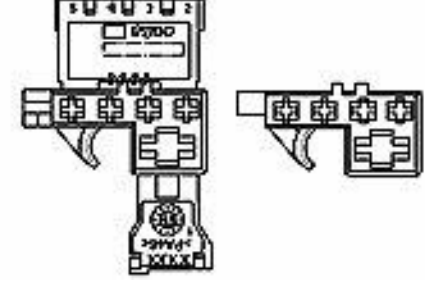

TE Part # 1393446-5  
V23540M6005Z 22=5 POL FL KONT



TE Part # 1-444017-1  
HSG ASSY TIMER 9P



TE Part # 1563775-1  
3POS,SPT,REC HSG,NO 2.LOCK,BK



## Also in the Series | Standard Power Timer

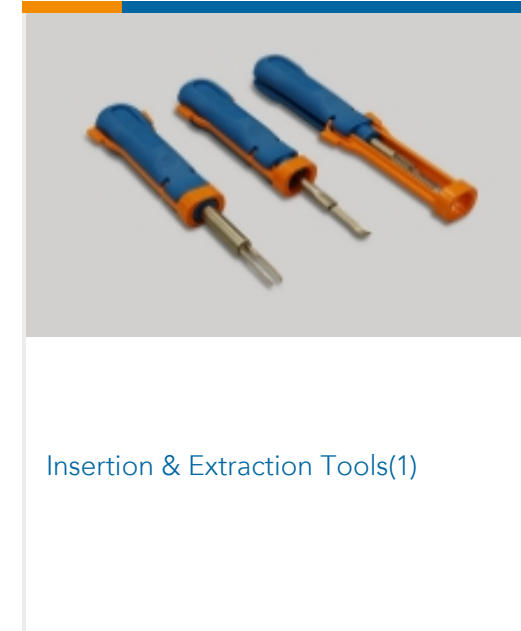
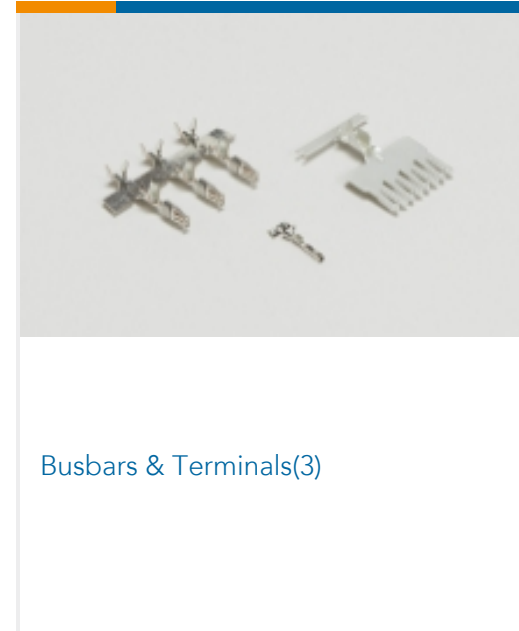
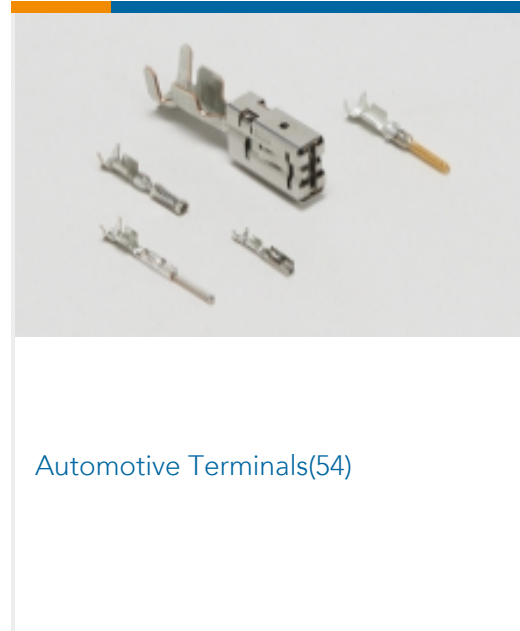
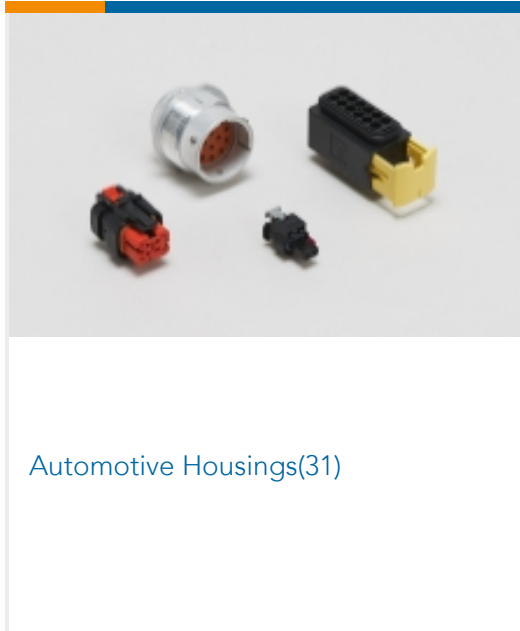

## Customers Also Bought

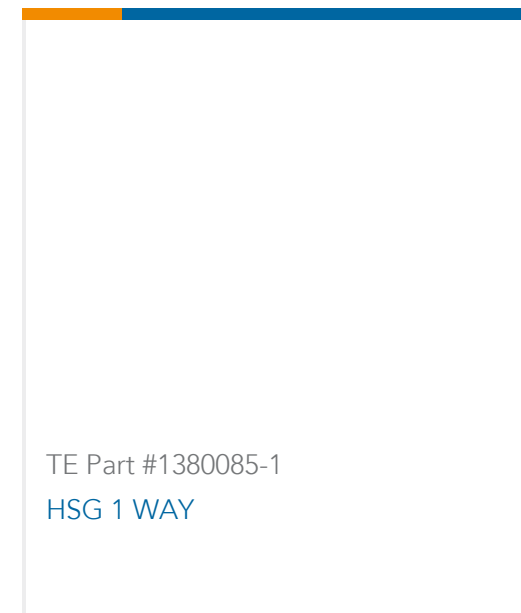



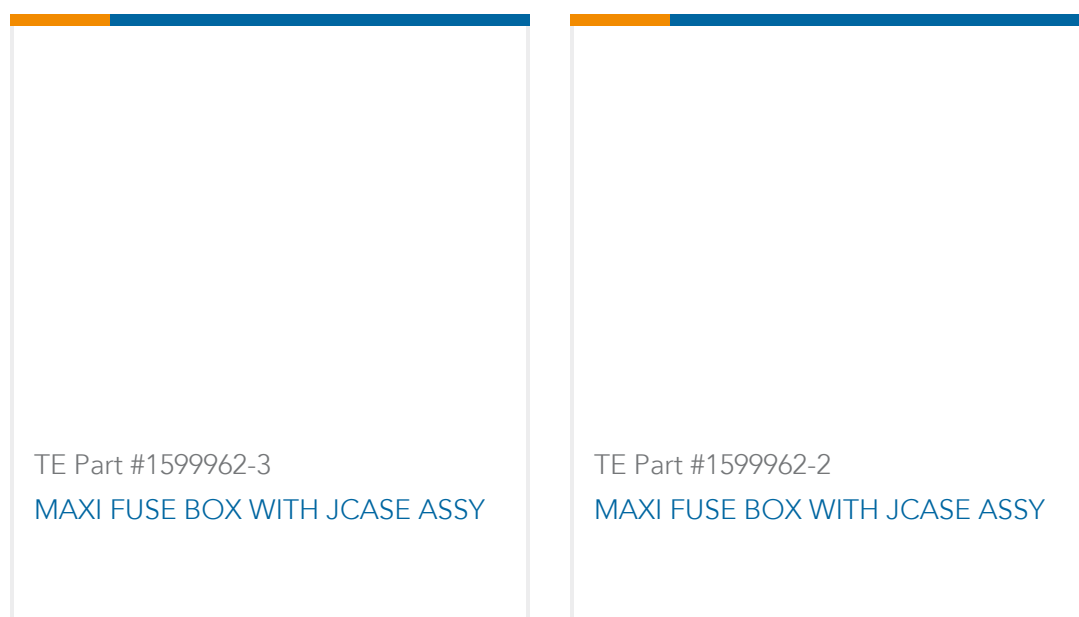

## Documents

### Product Drawings

[SPT A REC 6.3 Contact SRC Sn](#)

English

[SPT A REC 6.3 Contact SRC Sn](#)

English

### CAD Files

Customer View Model

[ENG\\_CVM\\_CVM\\_964324-1\\_B.2d\\_dxf.zip](#)

English

3D PDF

3D

Customer View Model

[ENG\\_CVM\\_CVM\\_964324-1\\_B.3d\\_igs.zip](#)

English

Customer View Model

[ENG\\_CVM\\_CVM\\_964324-1\\_B.3d\\_stp.zip](#)

English

By downloading the CAD file I accept and agree to the [Terms and Conditions](#) of use.

### Datasheets & Catalog Pages

[Timer Interconnection System](#)

English

### Product Specifications

[Application Specification](#)

German

[Application Specification](#)

English

[Application Specification](#)

English

### Product Environmental Compliance

[Product Compliance](#)

English

[Product Compliance](#)



English