

929974-1 ✓ ACTIVE

AMP | Round Connector System

TE Internal #: 929974-1

Automotive Terminals, Socket, Pin Diameter .098 in [2.5 mm], 20 – 17 AWG Wire Size, .5 – 1 mm<sup>2</sup> Wire Size, Sealable, Round Connector System

[View on TE.com >](#)



Terminals & Splices > Automotive Terminals > ROUND CONNECTOR SYSTEM, PIN AND SOCKET

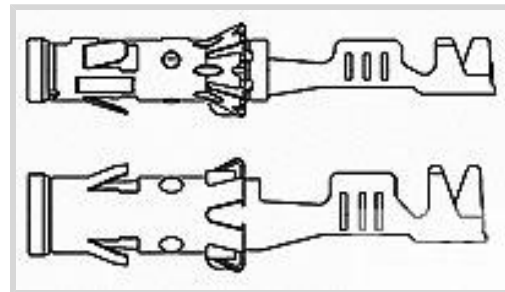

Terminal Type: **Socket**

Mating Pin Diameter: 2.5 mm [.098 in]

Terminal Transmits: 25 – 40 A (Power)

Wire Size: .5 – 1 mm<sup>2</sup>

[All Round Connector System, Pin and Socket \(74\)](#)

### Features

#### Product Type Features

Receptacle Style	180°
Sealable	Yes
Primary Locking Feature	Locking Lance

#### Body Features

Terminal Seal Type	Single Wire Seal (SWS)
--------------------	------------------------

#### Contact Features

Typical Current Rating	40 A
Crimp Type	F-Crimp
Terminal Type	Socket
Mating Pin Diameter	2.5 mm [.098 in]
Interface Plating	Tin (Sn)
Contact Termination Area Plating Material	Tin (Sn)

#### Termination Features

Termination Method to Wire & Cable	Crimp
Product Terminates To	Wire

#### Dimensions

Wire Size	.5 – 1 mm <sup>2</sup>
-----------	------------------------



Wire Size Search	17 AWG, 18 AWG, 19 AWG, 20 AWG
------------------	--------------------------------

Wire Insulation Diameter	1.2 – 2.1 mm [.047 – .082 in]
--------------------------	-------------------------------

### Usage Conditions

Insulation Option	Uninsulated
-------------------	-------------

Operating Temperature (Max)	80 °C, 85 °C, 90 °C, 100 °C, 105 °C, 110 °C, 120 °C, 125 °C, 130 °C [176 °F][185 °F][194 °F][212 °F][221 °F][230 °F][248 °F][257 °F][266 °F]
-----------------------------	----------------------------------------------------------------------------------------------------------------------------------------------

Operating Temperature Range	-40 – 130 °C [-40 – 266 °F]
-----------------------------	-----------------------------

### Operation/Application

Compatible With Wire Base Material	Copper
------------------------------------	--------

### Packaging Features

Packaging Method	Reel
------------------	------

Packaging Quantity	3000
--------------------	------

### Other

Terminal Transmits	25 – 40 A (Power)
--------------------	-------------------

## Product Compliance

[For compliance documentation, visit the product page on TE.com>](#)

EU RoHS Directive 2011/65/EU	Compliant
------------------------------	-----------

EU ELV Directive 2000/53/EC	Compliant
-----------------------------	-----------

China RoHS 2 Directive MIIT Order No 32, 2016	No Restricted Materials Above Threshold
-----------------------------------------------	-----------------------------------------

EU REACH Regulation (EC) No. 1907/2006	Current ECHA Candidate List: JAN 2022 (223) Candidate List Declared Against: JAN 2022 (223) Does not contain REACH SVHC
----------------------------------------	-------------------------------------------------------------------------------------------------------------------------------

Halogen Content	Low Halogen - Br, Cl, F, I < 900 ppm per homogenous material. Also BFR/CFR/PVC Free
-----------------	-------------------------------------------------------------------------------------















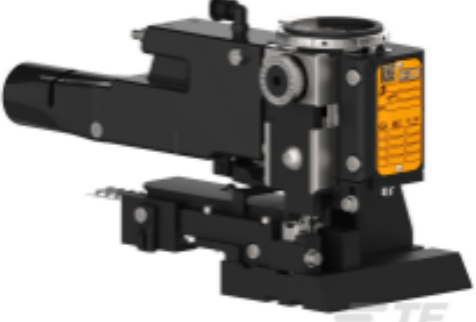

Solder Process Capability	Not applicable for solder process capability
---------------------------	----------------------------------------------

#### Product Compliance Disclaimer

This information is provided based on reasonable inquiry of our suppliers and represents our current actual knowledge based on the information they provided. This information is subject to change. The part numbers that TE has identified as EU RoHS compliant have a maximum concentration of 0.1% by weight in homogenous materials for lead, hexavalent chromium, mercury, PBB, PBDE, DBP, BBP, DEHP, DIBP, and 0.01% for cadmium, or qualify for an exemption to these limits as defined in the Annexes of Directive 2011/65/EU (RoHS2). Finished electrical and electronic equipment products will be CE marked as required by Directive 2011/65/EU. Components may not be CE marked. Additionally, the part

numbers that TE has identified as EU ELV compliant have a maximum concentration of 0.1% by weight in homogenous materials for lead, hexavalent chromium, and mercury, and 0.01% for cadmium, or qualify for an exemption to these limits as defined in the Annexes of Directive 2000/53/EC (ELV). Regarding the REACH Regulation, the information TE provides on SVHC in articles for this part number is based on the latest European Chemicals Agency (ECHA) 'Guidance on requirements for substances in articles' posted at this URL: <https://echa.europa.eu/guidance-documents/guidance-on-reach>

## Compatible Parts

 <p>TE Part # 58606-1 PROCrimp 1.5 &amp; 2.5MM PIN/SEAL</p>	 <p>TE Part # 1-1579007-8 EXTRACTION TOOL</p>	 <p>TE Part # 828920-1 EINZELADERDICHTUNG</p>	 <p>TE Part # 2305570-1 TERMINAL CUTTER, SIDE FEED</p>
 <p>TE Part # CAT-C4962-CH8172 CIRCULAR DIN HOUSINGS</p>	 <p>TE Part # 1394081-1 1,5/2,5MM BU-GEH31P</p>	 <p>TE Part # 4-967325-1 2,5MM BU-GEH 4P, BL</p>	 <p>TE Part # 2-2151139-1 OCEAN-2.0-APPLICATOR-S-080F160OV</p>
 <p>TE Part # 2-2151139-2 OCEAN-2.0-APPLICATOR-S-080F160OV</p>	 <p>TE Part # 2151139-1 OCEAN-2.0-APPLICATOR-S-080F160OV</p>	 <p>TE Part # 2151139-2 OCEAN-2.0-APPLICATOR-S-080F160OV</p>	 <p>TE Part # 2387332-1 SDE F 2.5mm CONTACT 0.35-1.0mm2 ASSY</p>
 <p>TE Part # 2387332-2 SDE F 2.5mm CONTACT 0.35-1.0mm2 DIE SET</p>	 <p>TE Part # 5-2151139-1 OCEAN-2.0-APPLICATOR-S-080F160OV</p>	 <p>TE Part # 5-2151139-2 OCEAN-2.0-APPLICATOR-S-080F160OV</p>	 <p>TE Part # 58606-2 PC DIE 1.5 &amp; 2.5 PIN W/S</p>



## Also in the Series | Round Connector System

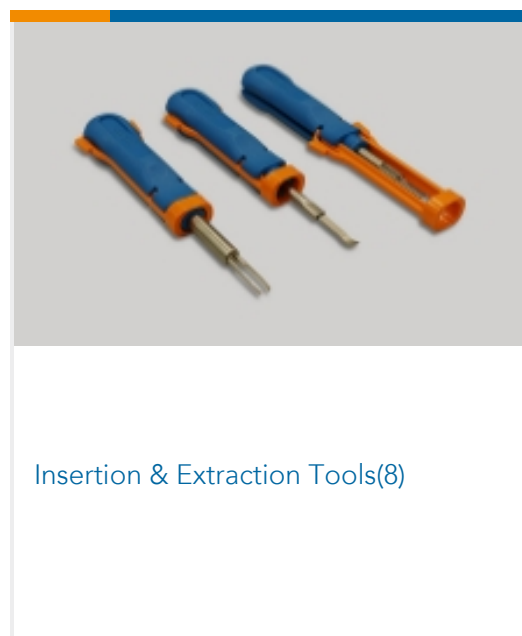
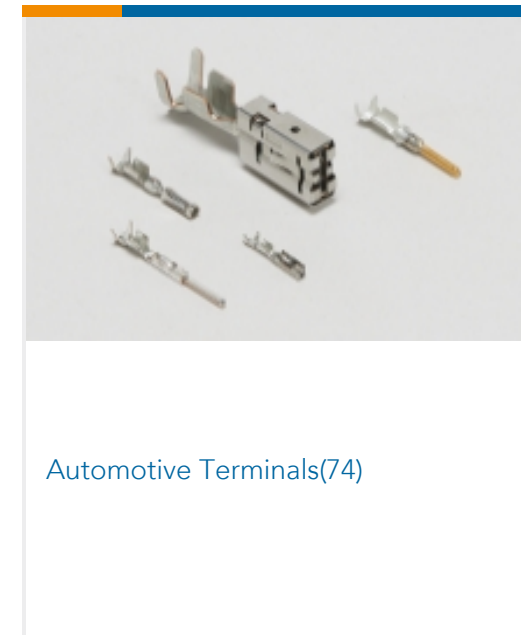
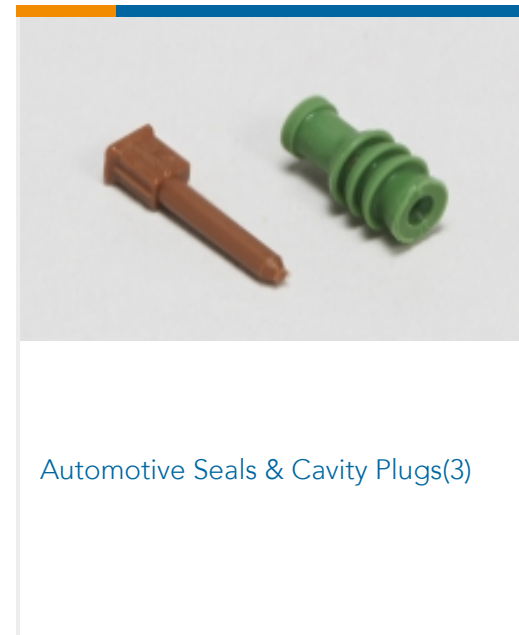
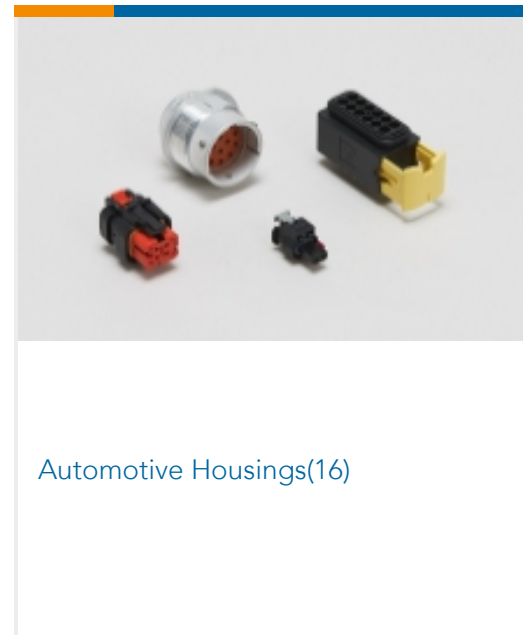

## Customers Also Bought

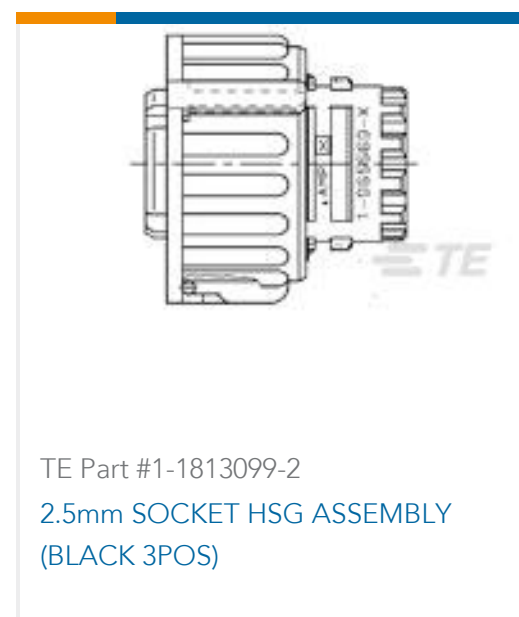



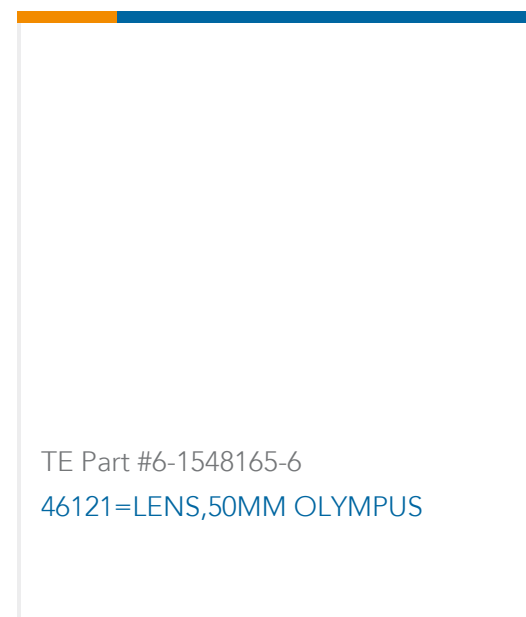
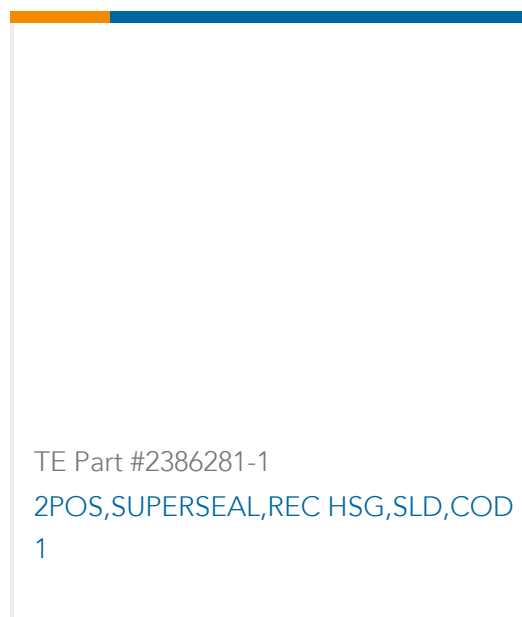

## Documents

### Product Drawings

#### BU-KONTAKT 2,5MMD

English

### CAD Files

#### Customer View Model

[ENG\\_CVM\\_929974-1\\_A5.3d\\_igs.zip](#)

English

#### Customer View Model

[ENG\\_CVM\\_929974-1\\_A5.3d\\_stp.zip](#)

English

#### Customer View Model

[ENG\\_CVM\\_929974-1\\_A5.2d\\_dxf.zip](#)

English

### 3D PDF

English

By downloading the CAD file I accept and agree to the [Terms and Conditions](#) of use.

### Datasheets & Catalog Pages

#### CONNECTOR SELECTOR

English

### Product Specifications

#### Application Specification

English

#### Application Specification

English

### Product Environmental Compliance

[MD\\_929974-1\\_05032018327\\_dmtec](#)

English

[MD\\_929974-1\\_05032018327\\_dmtec](#)

English