



[Positive Lock](#) | [Positive Lock 250](#)

TE Internal #: 927852-6

Quick Disconnects, Receptacle, 20 – 17 AWG Wire Size, .51 – 1.03 mm<sup>2</sup> Wire Size, Mating Tab Width .25 in [6.35 mm], Straight, Positive Lock 250

[View on TE.com >](#)

Terminals & Splices > Quick Disconnects

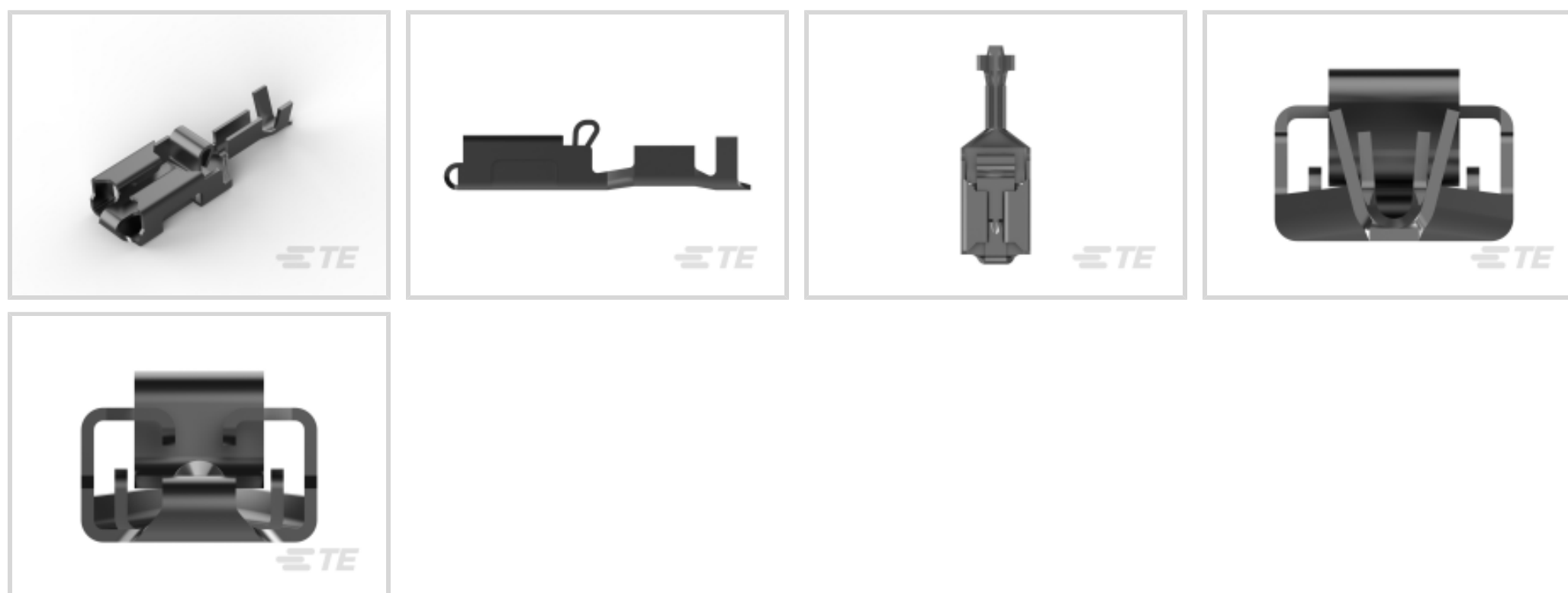

Quick Disconnect Terminal Type: **Receptacle**

Wire Size: .51 – 1.03 mm<sup>2</sup>

Mating Tab Width: 6.35 mm [.25 in]

Mating Tab Thickness: .81 mm [.032 in]

### Features

#### Product Type Features

Terminates To	Wire & Cable
Wire/Cable Type	FLK
Wire Stop	No
Insertion Force	Low
Sealable	No

#### Configuration Features

Connection Capacity	Single
---------------------	--------

#### Contact Features

Quick Disconnect Terminal Type	Receptacle
Mating Tab Width	6.35 mm [.25 in]
Mating Tab Thickness	.81 mm [.032 in]
Terminal Orientation	Straight
Contact Base Material	Phosphor Bronze
Terminal Plating Material	Pre-Tin
Crimp Type	F-Crimp



Barrel Type	Open
-------------	------

### Mechanical Attachment

Mating Retention Type	Dimple
Extraction Force	7 – 100 Newton
Wire Insulation Support	With

### Dimensions

Accepts Wire Insulation Diameter Range	1.4 – 2.31 mm [.055 – .091 in]
Receptacle Terminal Stock Thickness	.41 mm [.016 in]
Overall Length	22.3 mm [.878 in]
Wire Size	.51 – 1.03 mm <sup>2</sup>

### Usage Conditions

Insulation Option	Uninsulated
Operating Temperature Range	-40 – 110 °C [-40 – 230 °F]

### Industry Standards

UL Rating	Recognized
-----------	------------

### Packaging Features

Packaging Quantity	4500
Packaging Method	Strip/Reel

### Other

Comment	FLKr-Wire: Thin Walled Wire
---------	-----------------------------

### Product Compliance

[For compliance documentation, visit the product page on TE.com>](#)

EU RoHS Directive 2011/65/EU	Compliant
EU ELV Directive 2000/53/EC	Compliant
China RoHS 2 Directive MIIT Order No 32, 2016	No Restricted Materials Above Threshold
EU REACH Regulation (EC) No. 1907/2006	Current ECHA Candidate List: JAN 2022 (223) Candidate List Declared Against: JAN 2022 (223) Does not contain REACH SVHC
Halogen Content	Low Halogen - Br, Cl, F, I < 900 ppm per homogenous material. Also BFR/CFR/PVC Free



Solder Process Capability

Not applicable for solder process capability

Product Compliance Disclaimer

This information is provided based on reasonable inquiry of our suppliers and represents our current actual knowledge based on the information they provided. This information is subject to change. The part numbers that TE has identified as EU RoHS compliant have a maximum concentration of 0.1% by weight in homogenous materials for lead, hexavalent chromium, mercury, PBB, PBDE, DBP, BBP, DEHP, DIBP, and 0.01% for cadmium, or qualify for an exemption to these limits as defined in the Annexes of Directive 2011/65/EU (RoHS2). Finished electrical and electronic equipment products will be CE marked as required by Directive 2011/65/EU. Components may not be CE marked. Additionally, the part numbers that TE has identified as EU ELV compliant have a maximum concentration of 0.1% by weight in homogenous materials for lead, hexavalent chromium, and mercury, and 0.01% for cadmium, or qualify for an exemption to these limits as defined in the Annexes of Directive 2000/53/EC (ELV). Regarding the REACH Regulation, the information TE provides on SVHC in articles for this part number is based on the latest European Chemicals Agency (ECHA) 'Guidance on requirements for substances in articles' posted at this URL: <https://echa.europa.eu/guidance-documents/guidance-on-reach>

Compatible Parts



TE Part # 2305570-1  
TERMINAL CUTTER, SIDE FEED



TE Part # CAT-T4827-CH8172  
TIMER, CONNECTOR HOUSING



TE Part # 724659-2  
EXT TOOL FOR POSITIVE .250



TE Part # 142685-5  
L.I.F PL CONTACT 5MM 0.35-1 MM2 PTPPHBZ



TE Part # 2-2151161-2  
OCEAN\_2.0\_APPLICATOR-S-081F110OVA



TE Part # 2151161-2  
OCEAN\_2.0\_APPLICATOR-S-081F110OVA



TE Part # 7-2151161-2  
OCEAN\_2.0\_APPLICATOR-S-081F110OVA

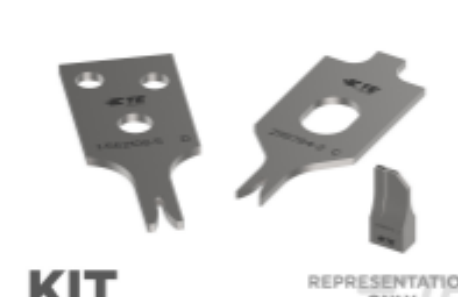

TE Part # 7-2151161-7  
OCEAN\_2.0\_SPARE\_PART\_KIT-081F110OV



TE Part # 539743-2  
DIE F2.8FF TAB



TE Part # 169400  
CERTI-LOK



TE Part # 734469  
MATRIZENPAAR



TE Part # 1-444017-1  
HSG ASSY TIMER 9P





## Also in the Series | Positive Lock 250

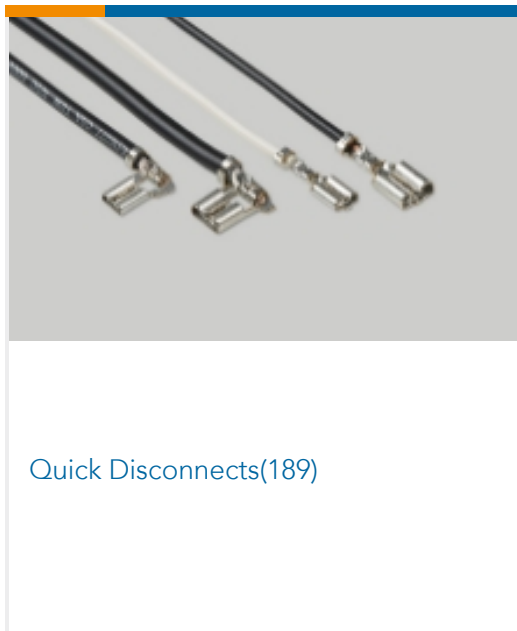
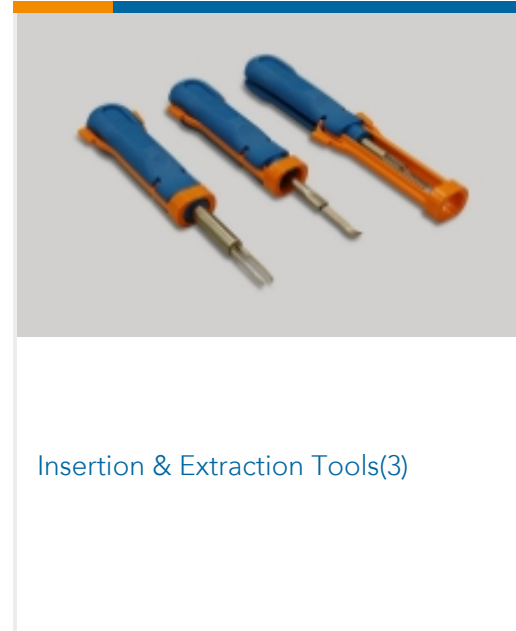
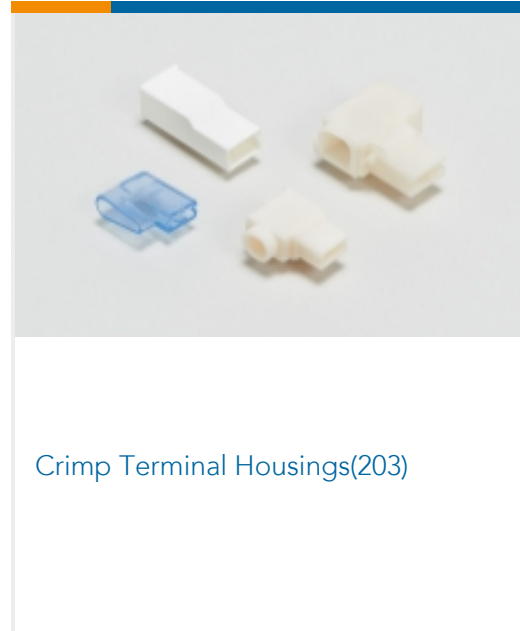
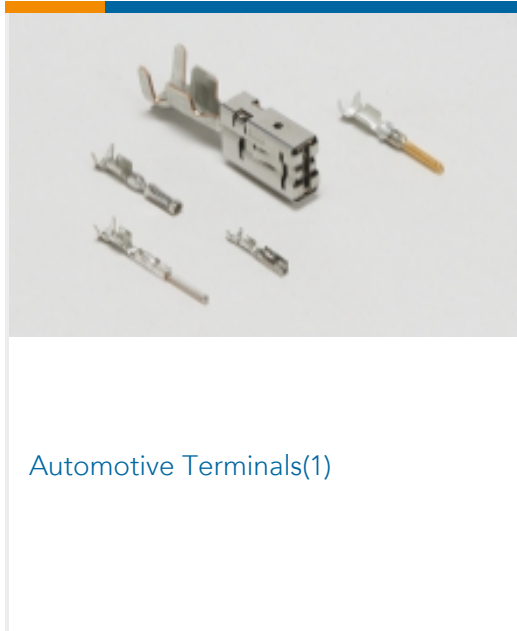

## Customers Also Bought

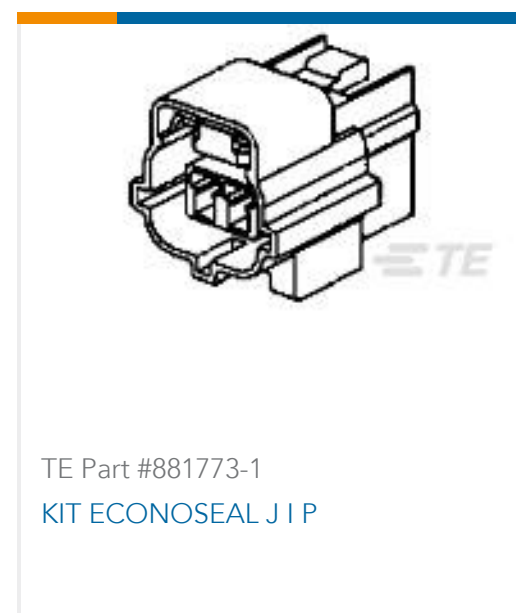

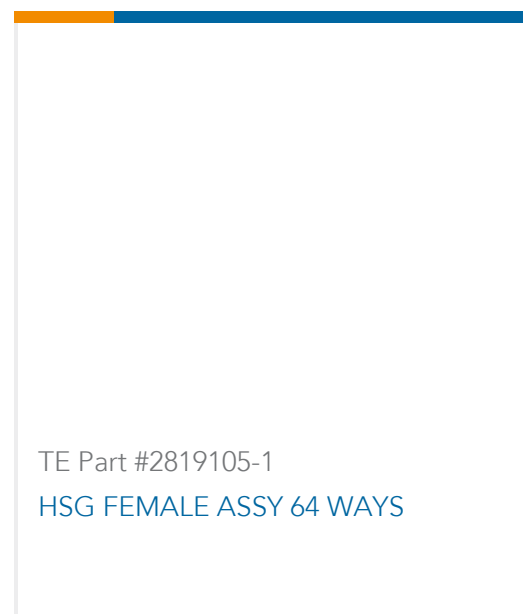

## Documents

### Product Drawings

[PL 250 REC TERMINAL 20-17 AWG PTPB](#)

English

### CAD Files

[3D PDF](#)

3D

Customer View Model

[ENG\\_CVM\\_CVM\\_927852-6\\_G.2d\\_dxf.zip](#)

English

Customer View Model

[ENG\\_CVM\\_CVM\\_927852-6\\_G.3d\\_igs.zip](#)

English

Customer View Model

[ENG\\_CVM\\_CVM\\_927852-6\\_G.3d\\_stp.zip](#)

English

By downloading the CAD file I accept and agree to the [Terms and Conditions](#) of use.

### Datasheets & Catalog Pages

[1654742\\_HOUSEHOLD\\_APPLIANCES\\_RAST5](#)

English

### Product Specifications

[6,3mm Positiv Lock Contact](#)

English

[Application Specification](#)

English

### Product Environmental Compliance

[MD\\_927852-6\\_04262018319\\_dmtec](#)

English

[MD\\_927852-6\\_04262018319\\_dmtec](#)

English