

DTM06-2S-EP10 ✓ ACTIVE

DEUTSCH | DEUTSCH DT, DEUTSCH DTM

TE Internal #: DTM06-2S-EP10

Housing for Female Terminals, Component-to-Wire, 2 Position, .165 in [4.19 mm] Centerline, Sealable, Black, Wire & Cable, Power & Signal, Hybrid

[View on TE.com >](#)



Connectors > Automotive Connectors > Connector Housings > DEUTSCH DTM HOUSINGS



Connector & Housing Type: **Housing for Female Terminals**

Mating Pin Diameter: **1.02 mm [.04 in]**

Connector System: **Component-to-Wire**

Number of Positions: **2**

Centerline (Pitch): **4.19 mm [.165 in]**

[All DEUTSCH DTM HOUSINGS \(95\)](#)

Features

Product Type Features

Connector & Housing Shape	Rectangular
Connector & Housing Type	Housing for Female Terminals
Connector System	Component-to-Wire
Sealable	Yes
Hybrid Connector	No
Primary Locking Feature	Integrated in Housing
Connector & Contact Terminates To	Wire & Cable

Configuration Features

Blank Cavity Position	0
Connector Modification	Terminating Resistor, J1939
Number of Positions	2
Number of Rows	1



Electrical Characteristics

Operating Voltage	250 VAC
Nominal Voltage Architecture	12 V, 24 V, 48 V

Body Features

Cable Exit Angle	180°
Body Material	PA GF
Primary Product Color	Black
Connector Code	B

Contact Features

Contact Size	Size 20
Contact Type	Socket
Mating Pin Diameter	1.02 mm[.04 in]
Contact Current Rating (Max)	7.5 A

Mechanical Attachment

Mounting Feature	Without
Terminal Position Assurance	Yes
Strain Relief	Add By Accessory
Mating Alignment Type	Keyed
Mating Alignment	With
Connector Mounting Type	Cable Mount (Free-Hanging)

Housing Features

Centerline (Pitch)	4.19 mm[.165 in]
--------------------	------------------

Dimensions

Product Width	14.45 mm[.569 in]
Product Length	29.08 mm[1.145 in]
Product Height	12.9 mm[.508 in]
Accepts Wire Insulation Diameter Range	1.35 – 3.05 mm[.053 – .12 in]

Usage Conditions

Operating Temperature (Max)	125 °C[257 °F]
Operating Temperature Range	-55 – 125 °C[-67 – 257 °F]

Operation/Application

Circuit Application	Power & Signal
---------------------	----------------



Industry Standards

Agency/Standard	SAE J2030
Degree of Protection	IP68, IP6K9K
UL Flammability Rating	20mm Flame Test per Standard UL-94

Packaging Features

Packaging Quantity	1000
Packaging Method	Box

Other

Serviceable	No
Connector Position Assurance Capable	No

Product Compliance

[For compliance documentation, visit the product page on TE.com>](#)

EU RoHS Directive 2011/65/EU	Compliant with Exemptions
EU ELV Directive 2000/53/EC	Compliant with Exemptions
China RoHS 2 Directive MIIT Order No 32, 2016	Restricted Materials Above Threshold
EU REACH Regulation (EC) No. 1907/2006	Current ECHA Candidate List: JAN 2022 (223) Candidate List Declared Against: JAN 2022 (223) SVHC > Threshold: Pb (1.2% in Component Part) Article Safe Usage Statements: Do not eat, drink or smoke when using this product. Wash thoroughly after handling. Recycle if possible and dispose of the article by following all applicable governmental regulations relevant to your geographic location.
Halogen Content	Not Low Halogen - contains Br or Cl > 900 ppm.
Solder Process Capability	Not reviewed for solder process capability

Product Compliance Disclaimer

This information is provided based on reasonable inquiry of our suppliers and represents our current actual knowledge based on the information they provided. This information is subject to change. The part numbers that TE has identified as EU RoHS compliant have a maximum concentration of 0.1% by weight in homogenous materials for lead, hexavalent chromium, mercury, PBB, PBDE, DBP, BBP, DEHP, DIBP, and 0.01% for cadmium, or qualify for an exemption to these limits as defined in the Annexes of Directive 2011/65/EU (RoHS2). Finished electrical and electronic equipment products will be CE marked as required by Directive 2011/65/EU. Components may not be CE marked. Additionally, the part numbers that TE has identified as EU ELV compliant have a maximum concentration of 0.1% by weight in homogenous materials for lead, hexavalent chromium, and mercury, and 0.01% for cadmium, or qualify for an exemption to these limits as defined in the Annexes of Directive 2000/53/EC (ELV). Regarding the REACH Regulation, the information TE provides on SVHC in articles for this part number is based on the latest European Chemicals Agency (ECHA) 'Guidance on requirements for substances in articles' posted at this URL: <https://echa.europa.eu/guidance-documents/guidance-on-reach>

Compatible Parts



TE Part # CAT-D485-CH8172
DEUTSCH DTM HOUSINGS



TE Part # CAT-D48-ST273
DEUTSCH SOLID CONTACTS



TE Part # 1028-041-0205
BKSHL, 2P, BLK, PLG, ST, NW 8.5



TE Part # CAT-D48-SFT273
DEUTSCH STAMPED & FORMED CONTACTS



TE Part # DTM04-2P-P083
REC, 2P, GRY, 220 OHM RESISTOR,
AU, A



TE Part # DTM04-2P-C035
REC, 2P, GRY, CAV 2 BLOCKED

Also in the Series | DEUTSCH DT



Automotive Connector Caps & Covers
(98)



Automotive Connector Locks &
Position Assurance(73)



Automotive Housings(619)



Automotive Seals & Cavity Plugs(4)



Insertion & Extraction Tools(3)

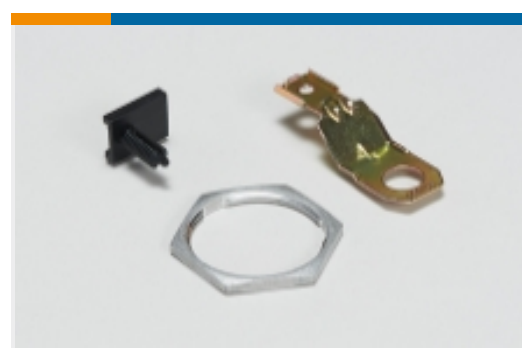

Other Automotive Connector
Accessories(14)



PCB Headers & Receptacles(106)

Also in the Series | DEUTSCH DTM



Automotive Connector Caps & Covers (34)



Automotive Connector Locks & Position Assurance(17)



Automotive Housings(98)



Insertion & Extraction Tools(2)



PCB Headers & Receptacles(42)

Customers Also Bought



TE Part #T4113502051-000
M12,MALE,RA,D CODE,5P,PG9,GOLD



TE Part #DRC18-40SB-P013
PLG, 40P, BLK, N, SEAL BOND, B



TE Part #YHDP24-24-47PEL024
DEUTSCH HDP20 HOUSINGS

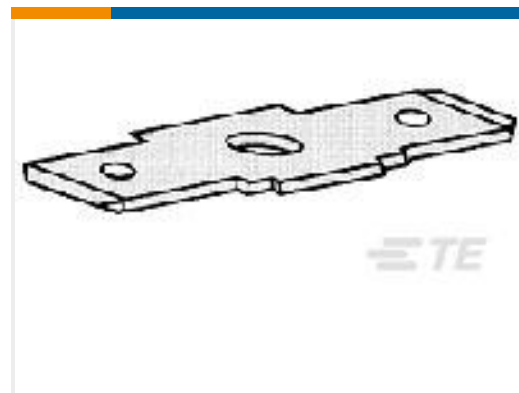

TE Part #62627-3
250 FASTON TAB BR



TE Part #CB5066-000
BSTS-27X4FR



TE Part #YAFD57-14-15PYC012
PLUG ASSY



TE Part #HC5732
LEAD CONNECTOR 35mm +VE



TE Part #HC5901
BATT.POST CLAMP -VE MK.3

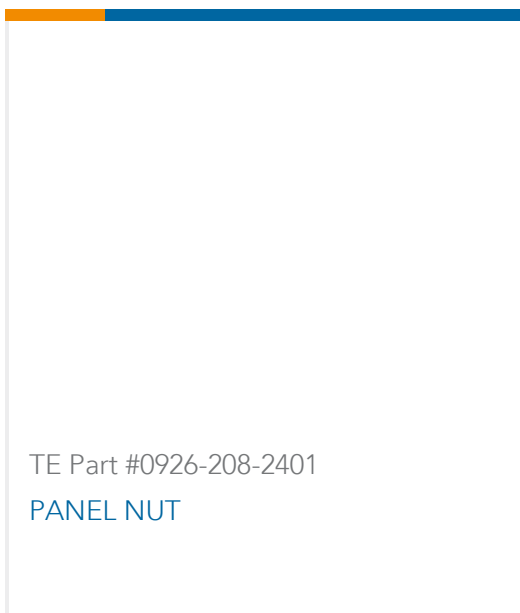

TE Part #0926-208-2401
PANEL NUT

Documents



Product Drawings

[PLG, 2P, BLK, 120 OHM RESISTOR, AU, B](#)

English

CAD Files

Customer View Model

[ENG_CVM_CVM_DTM06-2S-EP10_99.2d_dxf.zip](#)

English

[3D PDF](#)

3D

Customer View Model

[ENG_CVM_CVM_DTM06-2S-EP10_99.3d_igs.zip](#)

English

Customer View Model

[ENG_CVM_CVM_DTM06-2S-EP10_99.3d_stp.zip](#)

English

By downloading the CAD file I accept and agree to the [Terms and Conditions](#) of use.

Datasheets & Catalog Pages

[ICT Terminals and Connectors Catalogue](#)

English

[CONNECTOR SELECTOR](#)

English

Product Specifications

[Application Specification](#)

English

Product Environmental Compliance

[Product Compliance](#)

English

[Product Compliance](#)

English

Agency Approvals

[UL Report](#)

English