



AMP | 1.5/2.8 Connector System, Sensor Flat Contact System

TE Internal #: 967542-2

Automotive Terminals, Receptacle, Mating Tab Width 2.8 mm [.11 in], Tab Thickness .031 in [.8 mm], 20 – 17 AWG Wire Size, Sensor Flat Contact System

[View on TE.com >](#)

Terminals & Splices > Automotive Terminals > AMP MCP, SFC, RECEPTACLE

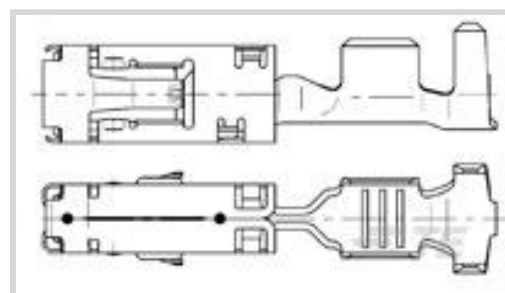

Terminal Type: **Receptacle**

Mating Tab Width: **2.8 mm [.11 in]**

Mating Tab Thickness: **.8 mm [.031 in]**

Terminal Transmits: **0 – 24 A (Low Power)**

Wire Size: **20 – 17 AWG**

[All AMP MCP, SFC, RECEPTACLE \(23\)](#)

Features

Product Type Features

Receptacle Style	180°
Sealable	Yes
Primary Locking Feature	Clean Body

Body Features

Terminal Seal Type	Single Wire Seal (SWS)
--------------------	------------------------

Contact Features

Typical Current Rating	11 A
Crimp Type	F-Crimp
Terminal Type	Receptacle
Mating Tab Width	2.8 mm [.11 in]
Mating Tab Thickness	.8 mm [.031 in]
Interface Plating	Gold (Au)
Contact Termination Area Plating Material	Tin (Sn)

Termination Features

Termination Method to Wire & Cable	Crimp
Product Terminates To	Wire



Dimensions

Wire Size	.5 – 1 mm ²
Wire Size Search	17 AWG, 18 AWG, 19 AWG, 20 AWG
Wire Insulation Diameter	1.3 – 2.1 mm [.051 – .083 in]

Usage Conditions

Insulation Option	Uninsulated
Operating Temperature (Max)	80 °C, 85 °C, 90 °C, 100 °C, 105 °C, 110 °C, 120 °C, 125 °C, 130 °C, 140 °C, 145 °C, 150 °C [176 °F][185 °F][194 °F][212 °F][221 °F][230 °F][248 °F][257 °F][266 °F][284 °F][293 °F][302 °F]
Operating Temperature Range	-40 – 150 °C [-40 – 302 °F]

Operation/Application

Compatible With Wire Base Material	Copper
------------------------------------	--------

Industry Standards

Agency/Standard	LV 214
-----------------	--------

Packaging Features

Packaging Method	Reel
Packaging Quantity	4000

Other

Terminal Transmits	0 – 24 A (Low Power)
--------------------	----------------------

Product Compliance

[For compliance documentation, visit the product page on TE.com>](#)

EU RoHS Directive 2011/65/EU	Compliant
EU ELV Directive 2000/53/EC	Compliant
China RoHS 2 Directive MIIT Order No 32, 2016	No Restricted Materials Above Threshold
EU REACH Regulation (EC) No. 1907/2006	Current ECHA Candidate List: JAN 2022 (223) Candidate List Declared Against: JAN 2022 (223) Does not contain REACH SVHC
Halogen Content	Low Halogen - Br, Cl, F, I < 900 ppm per homogenous material. Also BFR/CFR/PVC Free
Solder Process Capability	Not applicable for solder process capability

Product Compliance Disclaimer

This information is provided based on reasonable inquiry of our suppliers and represents our current actual knowledge based on the information they provided. This information is subject to change. The part numbers that TE has identified as EU RoHS compliant have a maximum concentration of 0.1% by weight in homogenous materials for lead, hexavalent chromium, mercury, PBB, PBDE, DBP, BBP, DEHP, DIBP, and 0.01% for cadmium, or qualify for an exemption to these limits as defined in the Annexes of Directive 2011/65/EU (RoHS2). Finished electrical and electronic equipment products will be CE marked as required by Directive 2011/65/EU. Components may not be CE marked. Additionally, the part numbers that TE has identified as EU ELV compliant have a maximum concentration of 0.1% by weight in homogenous materials for lead, hexavalent chromium, and mercury, and 0.01% for cadmium, or qualify for an exemption to these limits as defined in the Annexes of Directive 2000/53/EC (ELV). Regarding the REACH Regulation, the information TE provides on SVHC in articles for this part number is based on the latest European Chemicals Agency (ECHA) 'Guidance on requirements for substances in articles' posted at this URL: <https://echa.europa.eu/guidance-documents/guidance-on-reach>

Compatible Parts





Also in the Series | **1.5/2.8 Connector System**

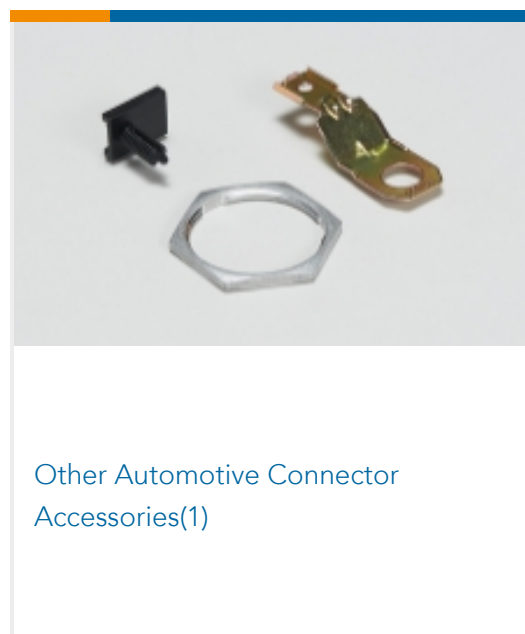
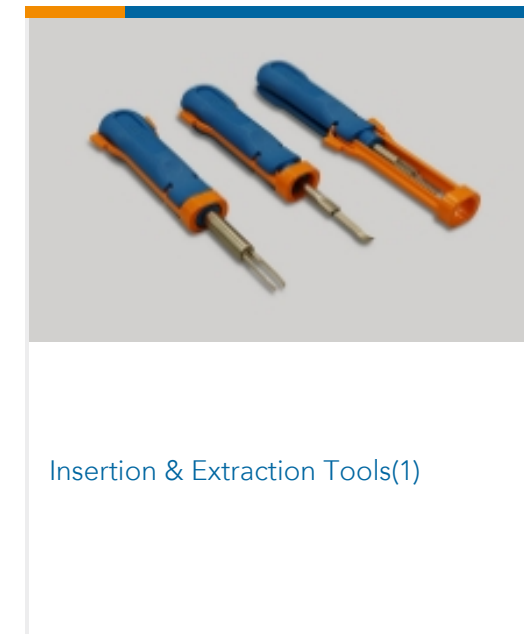
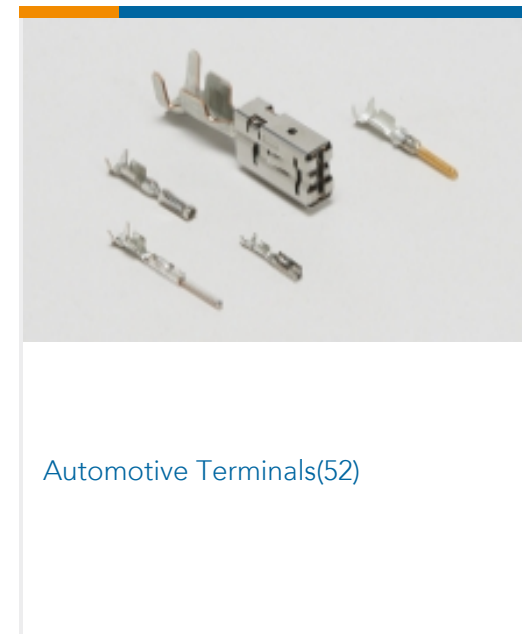
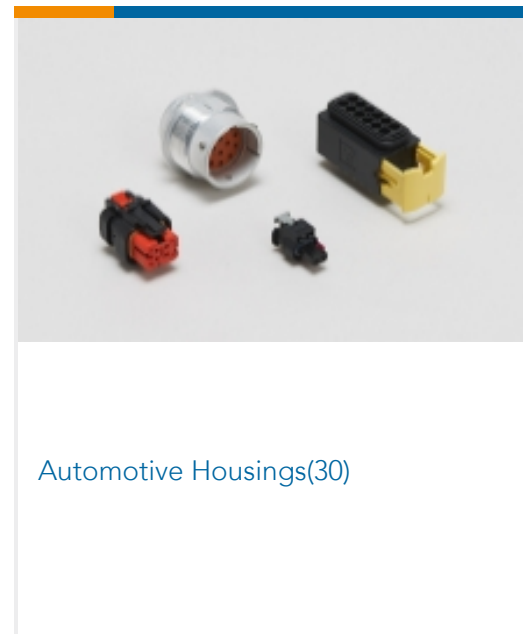

Also in the Series | **Sensor Flat Contact System**



Automotive Connector Caps & Covers (12)

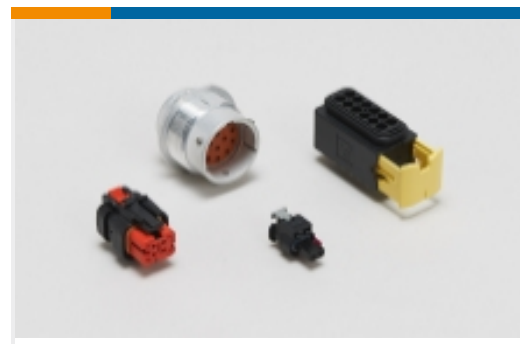

Automotive Housings(56)



Automotive Terminals(23)

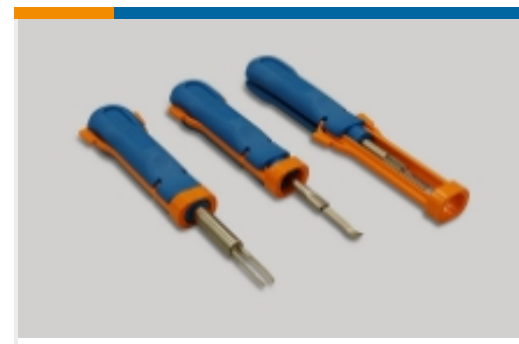

Insertion & Extraction Tools(7)

Customers Also Bought



TE Part #1-1670915-1
2POS, MCON 1.2 LL REC SEALED

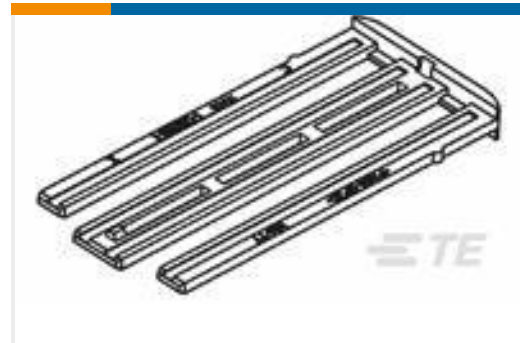

TE Part #1-1355118-1
RETAINER FOR 60POS SOCKET HSG



TE Part #928966-2
SPT REC 6.3 Contact SWS Sn



TE Part #1241406-1
AMP MCP 6.3/4.8K, CONTACT

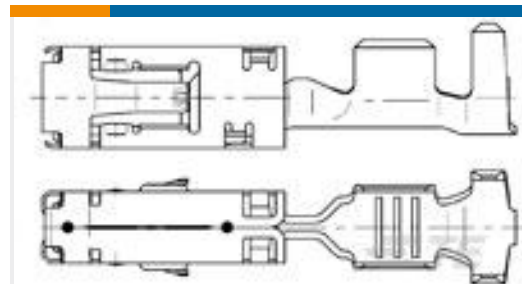

TE Part #967542-1
SENSOR FLA-KONT 2,8

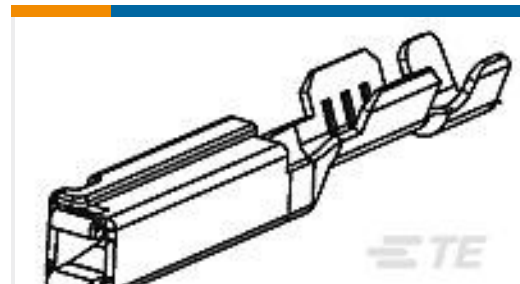

TE Part #1393364-2
V23540X7000Y 12=GET FEM TERM A

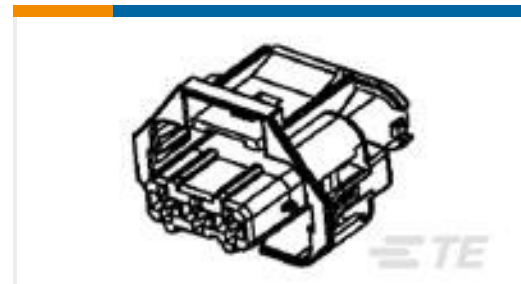

TE Part #936061-2
2.8MM SLD 3P PLUG ASSY-RAIL

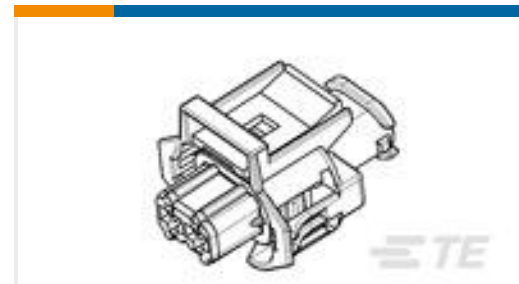

TE Part #936060-1
2.8MM SLD 3P PLUG ASSY-TDC



TE Part #936106-1
2.8MM SLD 3P PLUG RETAINER YEL

Documents

Product Drawings
[SENS FLA-KONT 2,8](#)

English

[SENS FLA-KONT 2,8](#)

English

CAD Files

Customer View Model

[ENG_CVM_967542-2_C5.3d_igs.zip](#)



English

Customer View Model

[ENG_CVM_967542-2_C5.3d_stp.zip](#)

English

Customer View Model

[ENG_CVM_967542-2_C5.2d_dxf.zip](#)

English

3D PDF

English

By downloading the CAD file I accept and agree to the [Terms and Conditions](#) of use.

Product Specifications

Application Specification

German

Application Specification

English

Application Specification

English

Product Environmental Compliance

Product Compliance

English

Product Compliance

English