

927367-1 ✓ ACTIVE

AMP | Timer Connector System

TE Internal #: 927367-1

Housing for Female Terminals, Wire-to-Wire, 8 Position, .2 in [5.08 mm] Centerline, Red, Signal, Cable Mount (Free-Hanging), Timer Connector System

[View on TE.com >](#)



Connectors > Automotive Connectors > Connector Housings > TIMER, CONNECTOR HOUSING

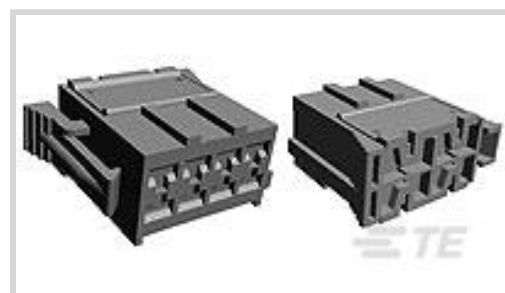

Connector & Housing Type: **Housing for Female Terminals**

Mating Tab Width: **2.8 mm [.11 in]**

Connector System: **Wire-to-Wire**

Number of Positions: **8**

Centerline (Pitch): **5.08 mm [.2 in]**

[All TIMER, CONNECTOR HOUSING \(543\)](#)

Features

Product Type Features

Connector & Housing Shape	Rectangular
Connector & Housing Type	Housing for Female Terminals
Connector System	Wire-to-Wire
Sealable	No
Hybrid Connector	No
Primary Locking Feature	On the Terminal

Configuration Features

Number of Positions	8
Number of Rows	2

Body Features

Body Material	PA
Primary Product Color	Red
Connector Code	C

Contact Features

Contact Size	2.8mm
Contact Type	Receptacle
Mating Tab Width	2.8 mm[.11 in]



Mechanical Attachment

Terminal Position Assurance	Yes
Strain Relief	Without
Mating Alignment Type	Keyed
Mating Alignment	With
Connector Mounting Type	Cable Mount (Free-Hanging)

Housing Features

Centerline (Pitch)	5.08 mm[.2 in]
--------------------	----------------

Dimensions

Product Width	13.8 mm[.543 in]
Product Length	28.8 mm[1.134 in]
Product Height	23 mm[.906 in]
Row-to-Row Spacing	5.08 mm[.2 in]

Operation/Application

Circuit Application	Signal
---------------------	--------

Packaging Features

Packaging Method	Bag
------------------	-----

Other

Serviceable	No
Connector Position Assurance Capable	No

Product Compliance

[For compliance documentation, visit the product page on TE.com>](#)

EU RoHS Directive 2011/65/EU	Compliant
EU ELV Directive 2000/53/EC	Compliant
China RoHS 2 Directive MIIT Order No 32, 2016	No Restricted Materials Above Threshold
EU REACH Regulation (EC) No. 1907/2006	Current ECHA Candidate List: JAN 2022 (223) Candidate List Declared Against: JAN 2022 (223) Does not contain REACH SVHC
Halogen Content	BFR/CFR/PVC Free, but Br/Cl >900 ppm in other sources.

Solder Process Capability

Not applicable for solder process capability

Product Compliance Disclaimer

This information is provided based on reasonable inquiry of our suppliers and represents our current actual knowledge based on the information they provided. This information is subject to change. The part numbers that TE has identified as EU RoHS compliant have a maximum concentration of 0.1% by weight in homogenous materials for lead, hexavalent chromium, mercury, PBB, PBDE, DBP, BBP, DEHP, DIBP, and 0.01% for cadmium, or qualify for an exemption to these limits as defined in the Annexes of Directive 2011/65/EU (RoHS2). Finished electrical and electronic equipment products will be CE marked as required by Directive 2011/65/EU. Components may not be CE marked. Additionally, the part numbers that TE has identified as EU ELV compliant have a maximum concentration of 0.1% by weight in homogenous materials for lead, hexavalent chromium, and mercury, and 0.01% for cadmium, or qualify for an exemption to these limits as defined in the Annexes of Directive 2000/53/EC (ELV). Regarding the REACH Regulation, the information TE provides on SVHC in articles for this part number is based on the latest European Chemicals Agency (ECHA) 'Guidance on requirements for substances in articles' posted at this URL: <https://echa.europa.eu/guidance-documents/guidance-on-reach>

Compatible Parts



TE Part # 969191-3
8 POS TAB HSG 2.8 X 0.8



TE Part # 925595-1
MIN.SPRING RECEPT.

Also in the Series | Timer Connector System



Automotive Connector Caps & Covers (11)

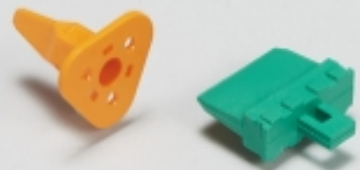

Automotive Connector Locks & Position Assurance(16)



Automotive Housings(219)



Automotive Seals & Cavity Plugs(31)

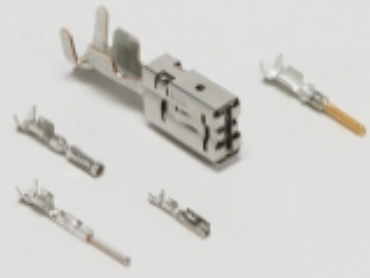

Automotive Terminals(140)

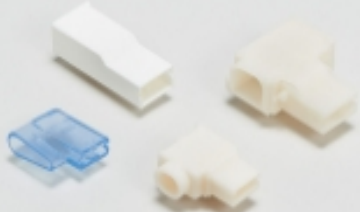

Crimp Terminal Housings(13)



Insertion & Extraction Tools(20)



Other Automotive Connector Accessories(1)



PCB Headers & Receptacles(78)



Quick Disconnects(4)

Customers Also Bought

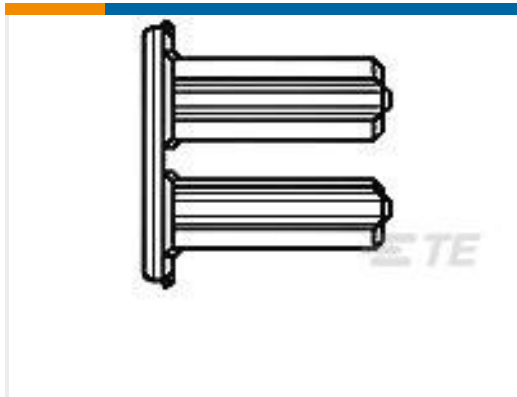
TE Part #967634-1
2. RETAINER FOR 18POSTE Part #969191-3
TIMER, CONNECTOR HOUSINGTE Part #1-967627-1
AMP MCP, UNSEALED CONNECTOR HOUSINGTE Part #925590-2
TIMER, RECEPTACLE AND TAB HOUSINGTE Part #1-5161390-0
10P.DIP SWITCH ASSY

Documents

Product Drawings

[8P MIN D-FLACHF GEH](#)

English

[8P MIN D-FLACHF GEH](#)

English

CAD Files

[3D PDF](#)

English

[Customer View Model](#)

[ENG_CVM_927367-1_E1.2d_dxf.zip](#)

English

[Customer View Model](#)

[ENG_CVM_927367-1_E1.3d_igs.zip](#)

English

[Customer View Model](#)

[ENG_CVM_927367-1_E1.3d_stp.zip](#)



English

By downloading the CAD file I accept and agree to the [Terms and Conditions](#) of use.

[Datasheets & Catalog Pages](#)

[Timer Interconnection System](#)

English