

917981-2 ✓ ACTIVE

AMP | Multilock Connector System

TE Internal #: 917981-2

Housing for Female Terminals, Wire-to-Board / Wire-to-Device, 16 Position, .118 in [3 mm] Centerline, Black, Signal, Multilock Connector System

[View on TE.com >](#)



Connectors > Automotive Connectors > Connector Housings > MULTILOCK, CONNECTOR HOUSING

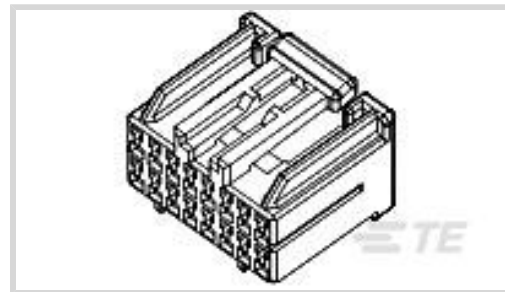

Connector & Housing Type: **Housing for Female Terminals**

Mating Tab Width: **1 mm [ .039 in ]**

Connector System: **Wire-to-Board, Wire-to-Device**

Number of Positions: **16**

Centerline (Pitch): **3 mm [ .118 in ]**

[All MULTILOCK, CONNECTOR HOUSING \(576\)](#)

## Features

### Product Type Features

Connector & Housing Shape	Rectangular
Connector & Housing Type	Housing for Female Terminals
Connector System	Wire-to-Board, Wire-to-Device
Sealable	No
Hybrid Connector	Yes
Primary Locking Feature	Integrated in Housing

### Configuration Features

Number of Positions	16
Number of Rows	2

### Electrical Characteristics

Operating Voltage	12 VDC
Nominal Voltage Architecture	12 V

### Body Features

Cable Exit Angle	180°
Body Material	PBT
Primary Product Color	Black



### Contact Features

Contact Size	1.8mm, 1mm
Contact Type	Receptacle
Mating Tab Width	1 mm[.039 in]

### Mechanical Attachment

Mounting Feature	Without
Terminal Position Assurance	Yes
Strain Relief	Without
Mating Alignment Type	Polarized
Mating Alignment	With
Connector Mounting Type	Cable Mount (Free-Hanging)

### Housing Features

Centerline (Pitch)	3 mm[.118 in]
--------------------	---------------

### Dimensions

Product Width	25 mm[.984 in]
Product Length	21 mm[.827 in]
Product Height	17.3 mm[.681 in]
Row-to-Row Spacing	5.2 mm[.205 in]

### Usage Conditions

Operating Temperature (Max)	70 °C, 75 °C, 80 °C, 85 °C, 90 °C, 100 °C, 105 °C[158 °F][167 °F][176 °F][185 °F][194 °F] [212 °F][221 °F]
Operating Temperature Range	-30 – 105 °C[-22 – 221 °F]

### Operation/Application

Circuit Application	Signal
---------------------	--------

### Industry Standards

UL Flammability Rating	UL 94HB
------------------------	---------

### Packaging Features

Packaging Quantity	100
Packaging Method	Bag

### Other

Serviceable	Yes
-------------	-----



Connector Position Assurance Capable

No

### Product Compliance



[For compliance documentation, visit the product page on TE.com>](#)

EU RoHS Directive 2011/65/EU	Compliant
EU ELV Directive 2000/53/EC	Compliant
China RoHS 2 Directive MIIT Order No 32, 2016	No Restricted Materials Above Threshold
EU REACH Regulation (EC) No. 1907/2006	Current ECHA Candidate List: JAN 2022 (223) Candidate List Declared Against: JUL 2021 (219) SVHC > Threshold: Not Yet Reviewed
Halogen Content	Low Halogen - Br, Cl, F, I < 900 ppm per homogenous material. Also BFR/CFR/PVC Free
Solder Process Capability	Not applicable for solder process capability

#### Product Compliance Disclaimer

This information is provided based on reasonable inquiry of our suppliers and represents our current actual knowledge based on the information they provided. This information is subject to change. The part numbers that TE has identified as EU RoHS compliant have a maximum concentration of 0.1% by weight in homogenous materials for lead, hexavalent chromium, mercury, PBB, PBDE, DBP, BBP, DEHP, DIBP, and 0.01% for cadmium, or qualify for an exemption to these limits as defined in the Annexes of Directive 2011/65/EU (RoHS2). Finished electrical and electronic equipment products will be CE marked as required by Directive 2011/65/EU. Components may not be CE marked. Additionally, the part numbers that TE has identified as EU ELV compliant have a maximum concentration of 0.1% by weight in homogenous materials for lead, hexavalent chromium, and mercury, and 0.01% for cadmium, or qualify for an exemption to these limits as defined in the Annexes of Directive 2000/53/EC (ELV). Regarding the REACH Regulation, the information TE provides on SVHC in articles for this part number is based on the latest European Chemicals Agency (ECHA) 'Guidance on requirements for substances in articles' posted at this URL: <https://echa.europa.eu/guidance-documents/guidance-on-reach>

### Compatible Parts

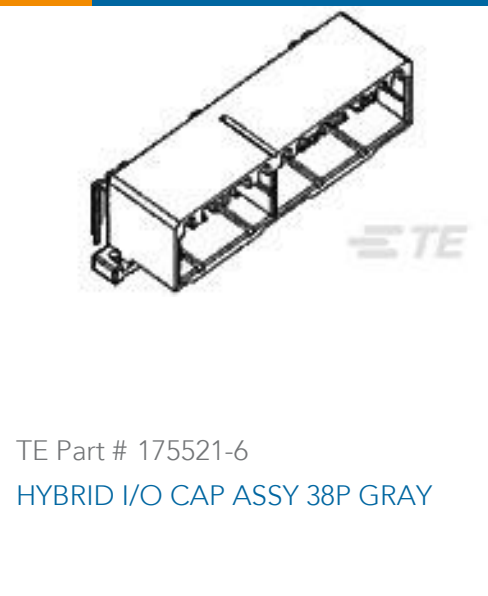
 <p>TE Part # CAT-HPCH5372 HIGH PIN COUNT HEADER</p>	 <p>TE Part # CAT-M9194-T273 MULTILOCK, RECEPTACLE AND TAB</p>	 <p>TE Part # CAT-SIGH262 SIGNAL HEADER</p>	 <p>TE Part # 175521-6 HYBRID I/O CAP ASSY 38P GRAY</p>
---	--	--	--



TE Part # 178780-1  
040/070 HYBRID CAP ASSY 76P

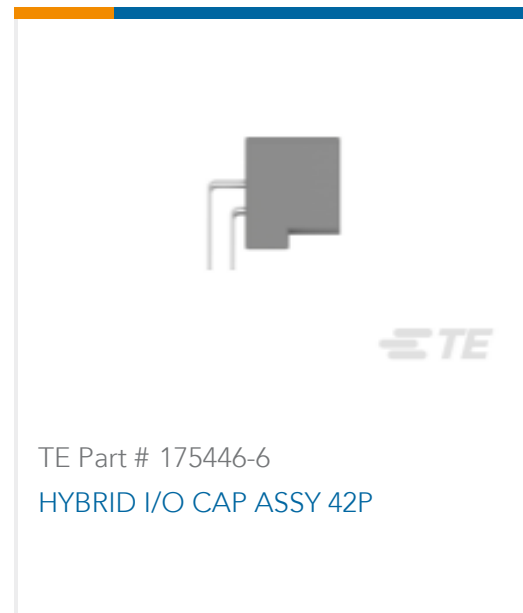

TE Part # 175446-6  
HYBRID I/O CAP ASSY 42P

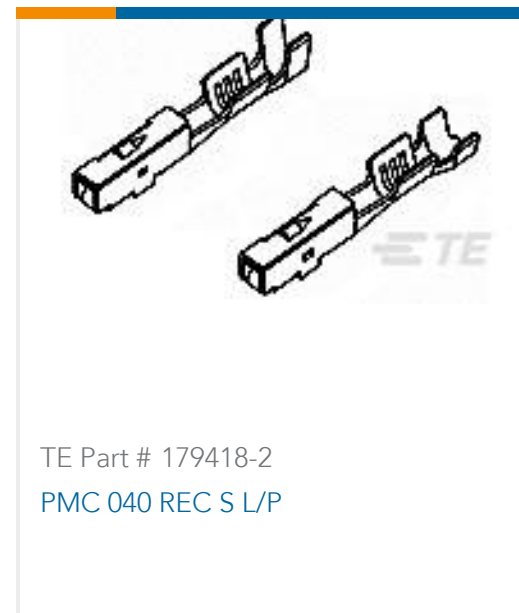

TE Part # 179418-2  
PMC 040 REC S L/P



TE Part # 175266-7  
040 REC CONT. SHORT FORM



TE Part # 175446-2  
040/070 HYBRID 42POS CAP ASSY H TIN

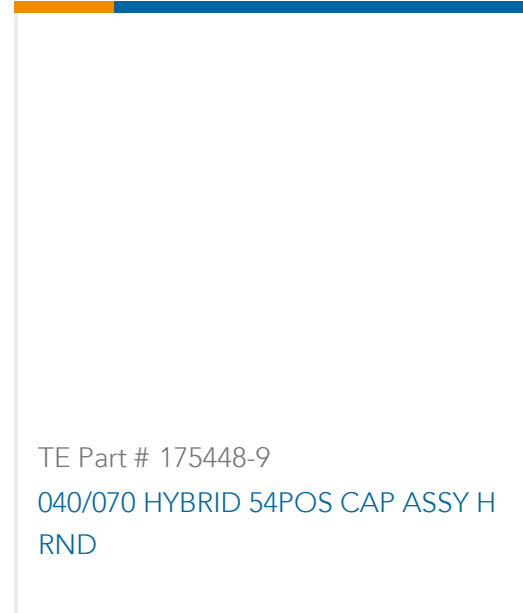

TE Part # 175448-9  
040/070 HYBRID 54POS CAP ASSY H RND



TE Part # 9-1438377-6  
38P HYB CAP ASSY GRAY I/B SCRE



TE Part # 9-1438424-2  
16P 040 VERT HYBRID HT CAP ASSY

## Also in the Series | Multilock Connector System

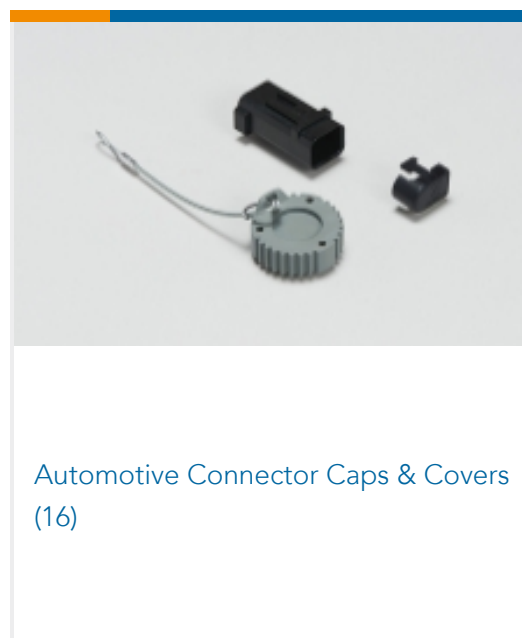

Automotive Connector Caps & Covers (16)



Automotive Connector EMC Shielding (1)



Automotive Connector Locks & Position Assurance(2)

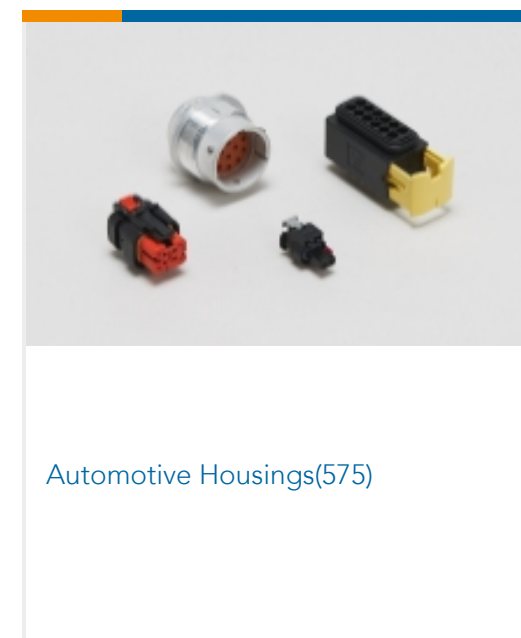

Automotive Housings(575)



Automotive Seals & Cavity Plugs(2)

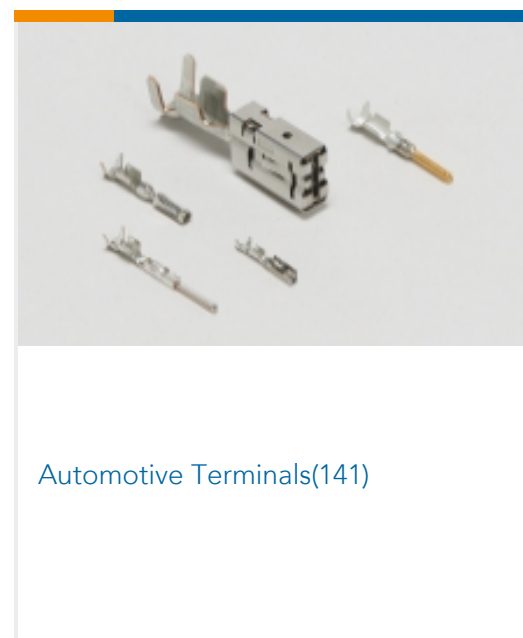

Automotive Terminals(141)

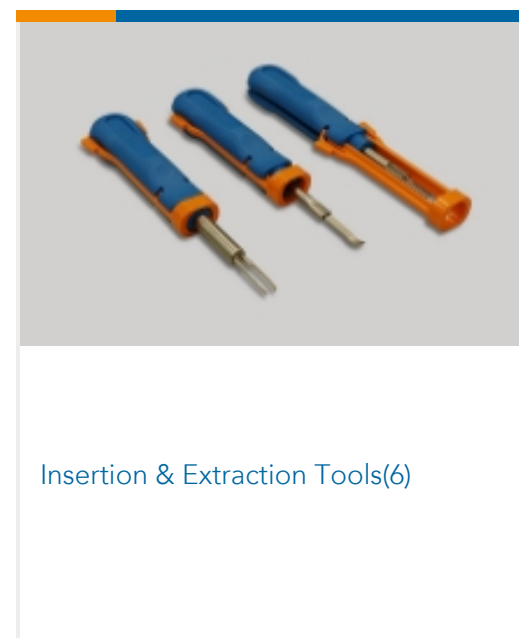

Insertion & Extraction Tools(6)

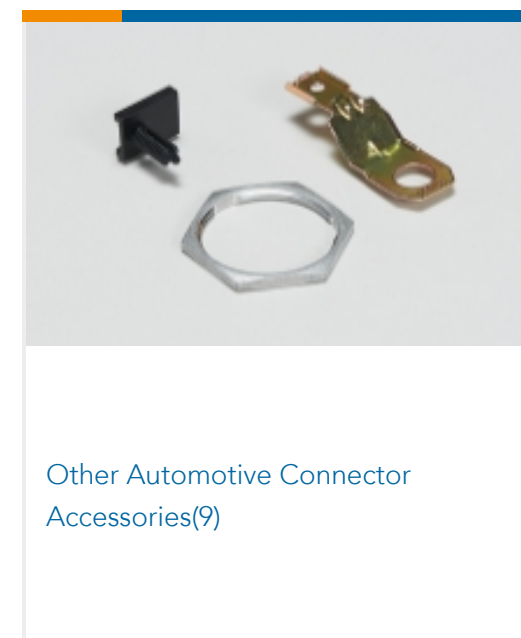

Other Automotive Connector Accessories(9)



PCB Headers & Receptacles(129)

## Customers Also Bought



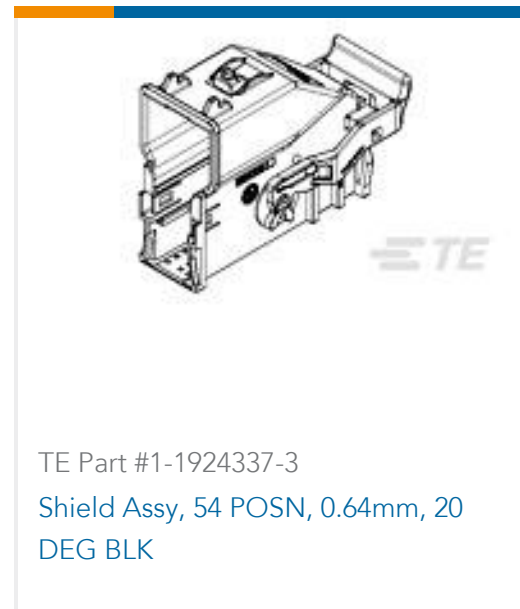
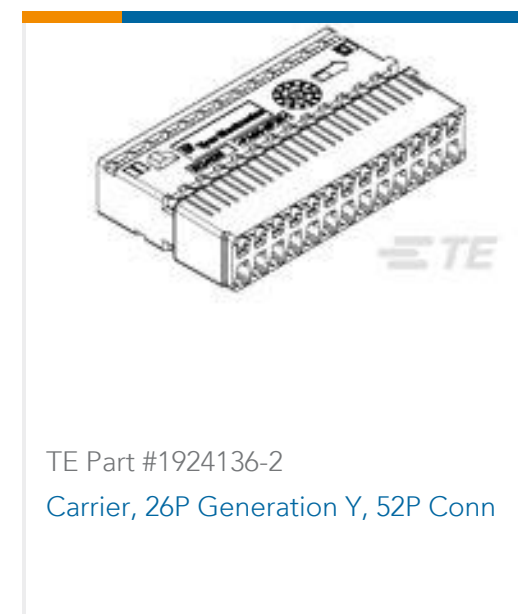

## Documents

### Product Drawings

[HYBRID MK-2 PLUG HSG ASSY 16P](#)

English

### CAD Files

[3D PDF](#)

English

**Customer View Model**

[ENG\\_CVM\\_917981-2\\_A.2d\\_dxf.zip](#)

English

**Customer View Model**

[ENG\\_CVM\\_917981-2\\_A.3d\\_igs.zip](#)

English

**Customer View Model**

[ENG\\_CVM\\_917981-2\\_A.3d\\_stp.zip](#)

English

By downloading the CAD file I accept and agree to the [Terms and Conditions](#) of use.

### Datasheets & Catalog Pages



## MULTILOCK Connector System

English

---

### Product Specifications

#### Application Specification

English

---

### Product Environmental Compliance

#### Product Compliance

English

#### Product Compliance

English

---

### Instruction Sheets

#### Instruction Sheet (U.S.)

Japanese