

HS025 防水コネクタ

HS025 SEALED CONNECTOR



HS025防水コネクタとは、Mターミナルタブ幅0.64mmの小型防水コネクタです。

HS025 SEALED CONNECTOR IS SMALL SIZED SEALED CONNECTOR AND THE BLADE WIDTH OF THE MALE TERMINAL FOR THIS CONNECTOR IS 0.64mm.

[特 徴]

- 1 ハウジング同士のガタツキを防止して耐振動性を向上させています。
- 2 フロントホルダプリセットタイプにより作業性を向上させました。

[DISTINCTIVE FEATURES]

1. STABLE HOUSING STRUCTURE ENABLES BETTER VIBRATION RESISTANCE.
2. FRONT HOLDER PRESET TYPE ENSURES BETTER OPERATION.

構造と名称 CONSTRUCTION

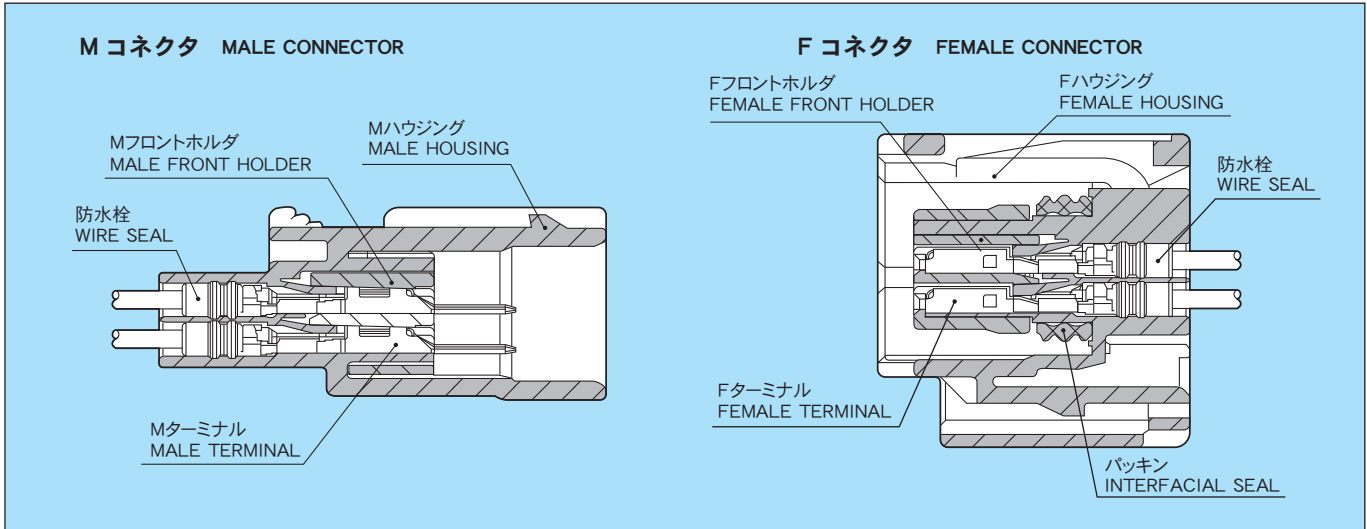

仕様 SPECIFICATIONS

| | | |
|----------------------------------------------|---------------------------|-------------------------------------------|
| 材 質 | ハウジング HOUSING | PBT |
| | Mターミナル MALE TERMINAL | 黄銅 (Sn メッキ) BRASS(TIN PLATING) |
| | Fターミナル FEMALE TERMINAL | 銅合金 (Sn メッキ) COPPER ALLOY(TIN PLATING) |
| ※許容電流 (参考値) ※CURRENT CAPACITY (REFERENCE) | | 3A |
| 低電圧低電流抵抗 RESISTANCE AT LOW VOLTAGE | | 5mΩ 以下 (初期値) 5mΩ MAX. (INITIAL VALUE) |
| 絶縁抵抗 INSULATION RESISTANCE | | DC500V 100MΩ 以上 DC500V 100MΩ MIN. |
| 耐電圧 DIELECTRIC STRENGTH | | AC1000V (1 分間) AC1000V (1 min.) |

※許容電流：使用極数・電線サイズ・通電時間及び使用温度により数値は異なります。

※ CURRENT CAPACITY WILL BE AFFECTED BY CONDITIONS SUCH AS POLE QUANTITY, WIRE SIZE, AMBIENT TEMPERATURE, ETC.

部品品番一覧 PART NUMBER CHART

| 部品名称 PART NAME | M | F |
|-------------------|----------------------------------------------|----------------------------------------------|
| ターミナル TERMINAL | 7114-4415-02 7114-4416-02 7114-4417-02 | 7116-4415-02 7116-4416-02 7116-4417-02 |

| 部品名称 PART NAME | M・F 共通 COMMON FOR MALE AND FEMALE |
|-------------------|------------------------------------------------------------------------------|
| 防水栓 WIRE SEAL | 7158-3165-90 7158-3166-60 7158-3167-80 7158-3168-80 7158-3169-40 |

| 部品名称 PART NAME | 極数 POLES | M | F |
|-------------------|-------------|-----------|-----------|
| ハウジング HOUSING | 2 | 7282-2090 | 7283-2090 |
| | 3 | 7282-2147 | 7283-2147 |
| | 4 | 7282-2763 | 7283-2763 |
| | 6 | 7282-2764 | 7283-2764 |
| | 8 | 7282-2148 | 7283-2148 |
| | 12 | 7282-4038 | 7283-4038 |

ターミナル TERMINAL

単位：mm UNIT:mm

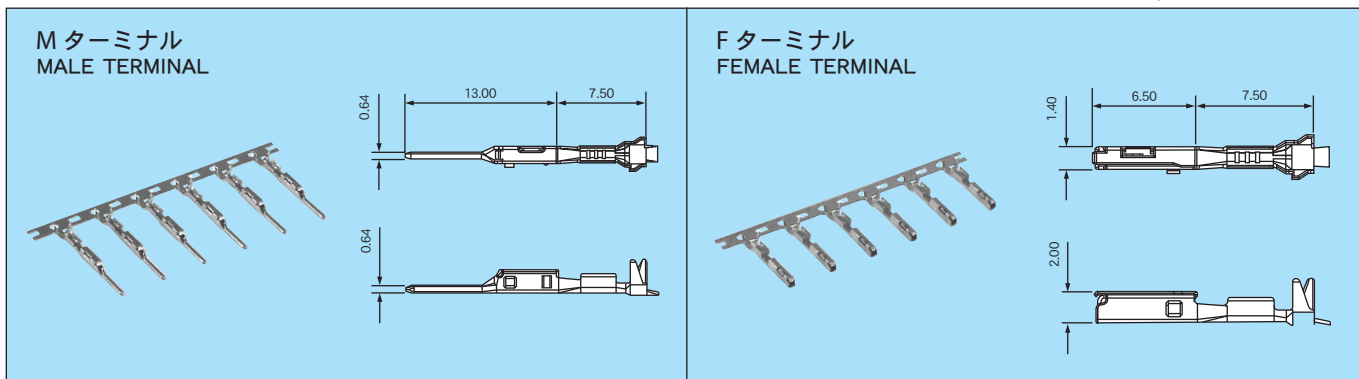

仕様 SPECIFICATIONS

| 部品名称 PART NAME | 品番 PART NUMBER | 材質 MATERIAL | 表面処理 TREATMENT | 板厚 (mm) MATERIAL THICKNESS |
|----------------------------|-------------------|---------------------|----------------------|-------------------------------|
| M ターミナル MALE TERMINAL | 7114-4415-02 | 黄銅 BRASS | Snメッキ TIN PLATING | 0.2 |
| | 7114-4416-02 | | | |
| | 7114-4417-02 | | | |
| F ターミナル FEMALE TERMINAL | 7116-4415-02 | 銅合金 COPPER ALLOY | Snメッキ TIN PLATING | 0.2 |
| | 7116-4416-02 | | | |
| | 7116-4417-02 | | | |

防水栓 WIRE SEAL

単位：mm UNIT:mm

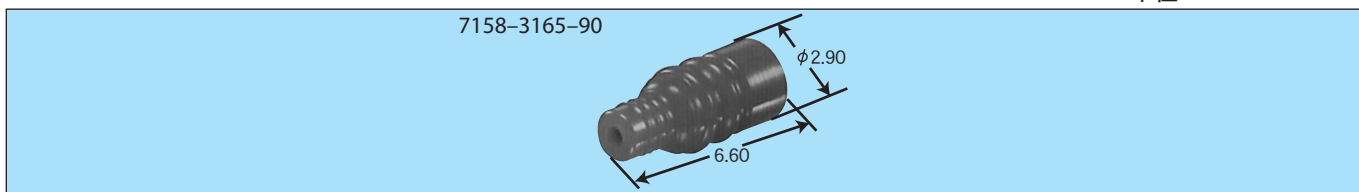

仕様 SPECIFICATIONS

| 部品名称 PART NAME | 品番 PART NUMBER | 材質 MATERIAL | 色相 COLOR | 備考 NOTE |
|-------------------|-------------------|--------------------|------------------|-------------------|
| 防水栓 WIRE SEAL | 7158-3165-90 | シリコンゴム SILICONE | 青 BLUE | |
| | 7158-3166-60 | シリコンゴム SILICONE | 緑 GREEN | |
| | 7158-3167-80 | シリコンゴム SILICONE | 茶 BROWN | |
| | 7158-3168-80 | シリコンゴム SILICONE | 濃茶 DARK BROWN | |
| | 7158-3169-40 | シリコンゴム SILICONE | 灰 GRAY | 空栓 CAVITY PLUG |

適用電線一覧 APPLICABLE WIRE CHART

| 部品名称 PART NAME | 適用電線サイズ (mm ²) WIRE SIZE (mm ²) | 電線品種 WIRE TYPE | 端子品番 PART NUMBER (TERMINAL) | 防水栓品番 PART NUMBER (WIRE SEAL) |
|----------------------------|------------------------------------------------------------|-------------------|--------------------------------|----------------------------------|
| M ターミナル MALE TERMINAL | 0.3 | CAVS | 7114-4415-02 | 7158-3166-60 |
| | | CAVUS | | 7158-3165-90 |
| | 0.5 | CAVS | 7114-4416-02 | 7158-3167-80 |
| | | CAVUS | | 7158-3165-90 |
| | 0.85 | CAVS | 7114-4417-02 | 7158-3168-80 |
| | | CAVUS | | 7158-3167-80 |
| F ターミナル FEMALE TERMINAL | 0.3 | CAVS | 7116-4415-02 | 7158-3166-60 |
| | | CAVUS | | 7158-3165-90 |
| | 0.5 | CAVS | 7116-4416-02 | 7158-3167-80 |
| | | CAVUS | | 7158-3165-90 |
| | 0.85 | CAVS | 7116-4417-02 | 7158-3168-80 |
| | | CAVUS | | 7158-3167-80 |

ハウジング 材質 : PBT HOUSING MATERIAL: PBT

単位 : mm UNIT: mm

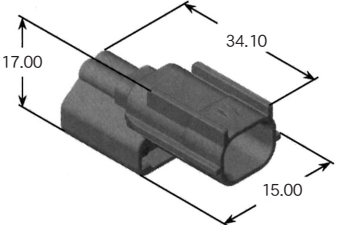
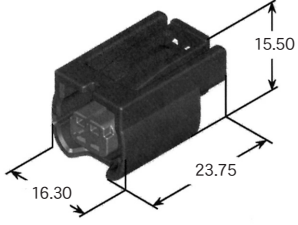
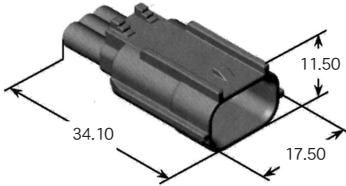
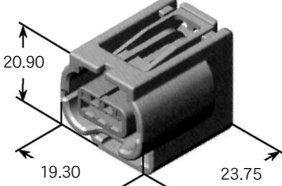
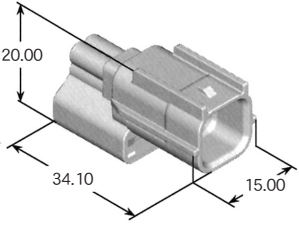
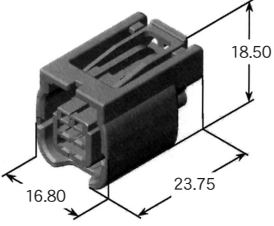
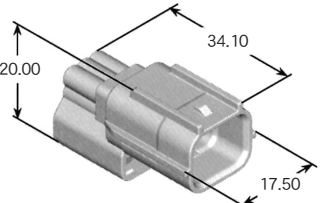
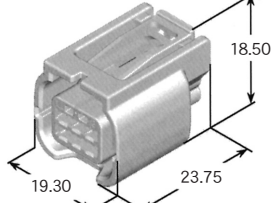
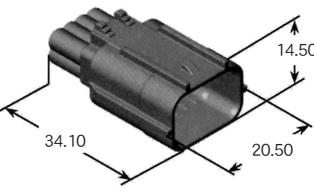
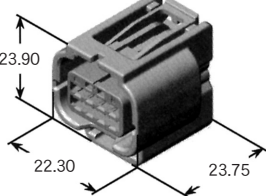
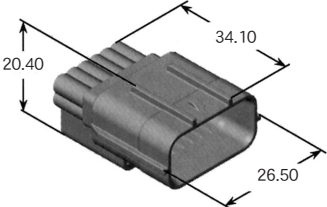
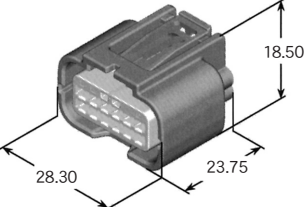
| 極数 POLES | M ハウジング MALE HOUSING | F ハウジング FEMALE HOUSING |
|-------------|------------------------------------------------------------------------------------------------------|--------------------------------------------------------------------------------------------------------|
| 2 |  <p>7282-2090</p> |  <p>7283-2090</p> |
| 3 |  <p>7282-2147</p> |  <p>7283-2147</p> |
| 4 |  <p>7282-2763</p> |  <p>7283-2763</p> |
| 6 |  <p>7282-2764</p> |  <p>7283-2764</p> |
| 8 |  <p>7282-2148</p> |  <p>7283-2148</p> |
| 12 |  <p>7282-4038</p> |  <p>7283-4038</p> |