

284848-1 ✓ ACTIVE

AMP | AMP MCP 1.5K, AMP MCP 2.8, AMP MCP Connector System

TE Internal #: 284848-1

Housing for Female Terminals, Wire-to-Wire, 12 Position, .197 in [5 mm] Centerline, Sealable, Black, Signal, Cable Mount (Free-Hanging), Hybrid

[View on TE.com >](#)



Connectors > Automotive Connectors > Connector Housings > AMP MCP, SEALED CONNECTOR HOUSING



Connector & Housing Type: **Housing for Female Terminals**

Mating Tab Width: **1.6 mm, 2.8 mm [.063 in, .11 in]**

Connector System: **Wire-to-Wire**

Number of Positions: **12**

Centerline (Pitch): **5 mm [.197 in]**

[All AMP MCP, SEALED CONNECTOR HOUSING \(158\)](#)

Features

Product Type Features

Connector & Housing Shape	Rectangular
Connector & Housing Type	Housing for Female Terminals
Connector System	Wire-to-Wire
Sealable	Yes
Hybrid Connector	Yes
Primary Locking Feature	On the Terminal

Configuration Features

Number of Positions	12
Number of Rows	2

Electrical Characteristics

Operating Voltage	24 VDC
Nominal Voltage Architecture	12 V, 24 V

Body Features

Cable Exit Angle	180°
Body Material	PA GF
Primary Product Color	Black



Contact Features

Contact Size	1.5mm, 2.8mm
Contact Type	Receptacle
Mating Tab Width	1.6 mm, 2.8 mm [.063 in][.11 in]

Mechanical Attachment

Mounting Feature	Without
Terminal Position Assurance	Yes
Strain Relief	Without
Mating Alignment Type	Polarization Slot
Mating Alignment	With
Connector Mounting Type	Cable Mount (Free-Hanging)

Housing Features

Centerline (Pitch)	5 mm [.197 in]
--------------------	----------------

Dimensions

Product Width	26.6 mm [1.047 in]
Product Length	45.8 mm [1.803 in]
Product Height	32.6 mm [1.283 in]
Row-to-Row Spacing	4.5 mm [.177 in]

Usage Conditions

Operating Temperature (Max)	70 °C, 75 °C, 80 °C, 85 °C, 90 °C, 100 °C, 105 °C, 110 °C, 120 °C, 125 °C [158 °F][167 °F][176 °F][185 °F][194 °F][212 °F][221 °F][230 °F][248 °F][257 °F]
Operating Temperature Range	-25 – 125 °C [-13 – 257 °F]

Operation/Application

Circuit Application	Signal
---------------------	--------

Packaging Features

Packaging Quantity	500
Packaging Method	Box

Other

Serviceable	No
Connector Position Assurance Capable	Yes



Product Compliance





[For compliance documentation, visit the product page on TE.com>](#)

EU RoHS Directive 2011/65/EU	Compliant
EU ELV Directive 2000/53/EC	Compliant
China RoHS 2 Directive MIIT Order No 32, 2016	No Restricted Materials Above Threshold
EU REACH Regulation (EC) No. 1907/2006	Current ECHA Candidate List: JAN 2022 (223) Candidate List Declared Against: JUL 2021 (219) SVHC > Threshold: Not Yet Reviewed
Halogen Content	Low Halogen - Br, Cl, F, I < 900 ppm per homogenous material. Also BFR/CFR/PVC Free
Solder Process Capability	Not applicable for solder process capability

Product Compliance Disclaimer

This information is provided based on reasonable inquiry of our suppliers and represents our current actual knowledge based on the information they provided. This information is subject to change. The part numbers that TE has identified as EU RoHS compliant have a maximum concentration of 0.1% by weight in homogenous materials for lead, hexavalent chromium, mercury, PBB, PBDE, DBP, BBP, DEHP, DIBP, and 0.01% for cadmium, or qualify for an exemption to these limits as defined in the Annexes of Directive 2011/65/EU (RoHS2). Finished electrical and electronic equipment products will be CE marked as required by Directive 2011/65/EU. Components may not be CE marked. Additionally, the part numbers that TE has identified as EU ELV compliant have a maximum concentration of 0.1% by weight in homogenous materials for lead, hexavalent chromium, and mercury, and 0.01% for cadmium, or qualify for an exemption to these limits as defined in the Annexes of Directive 2000/53/EC (ELV). Regarding the REACH Regulation, the information TE provides on SVHC in articles for this part number is based on the latest European Chemicals Agency (ECHA) 'Guidance on requirements for substances in articles' posted at this URL: <https://echa.europa.eu/guidance-documents/guidance-on-reach>

Compatible Parts

 <p>TE Part # 828922-1 2,5MM CAVITY PLUG FOR 5,4MM DI</p>	 <p>TE Part # 963294-1 SINGLE WIRE SEAL INSULATION DI</p>	 <p>TE Part # CAT-AM705-CH8172 AMP MCP, SEALED CONNECTOR HOUSING</p>	 <p>TE Part # CAT-AM705-T273 AMP MCP, RECEPTACLE AND TAB</p>
--	--	---	---

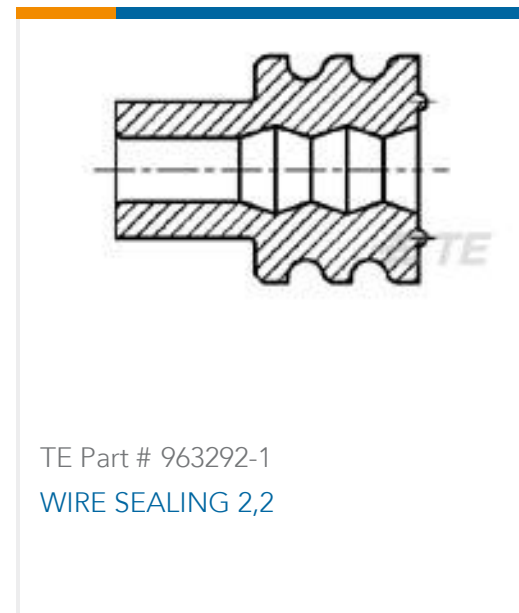

Also in the Series | AMP MCP 1.5K

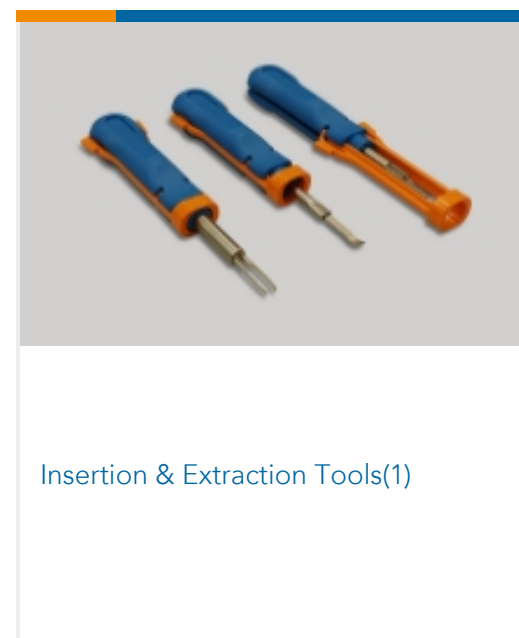
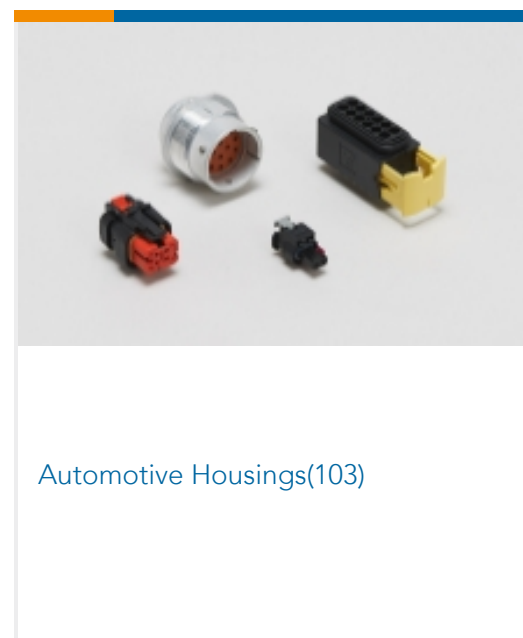
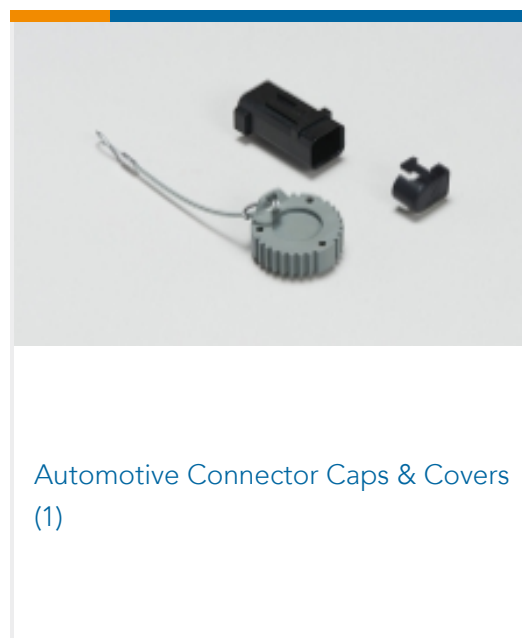

Also in the Series | AMP MCP 2.8

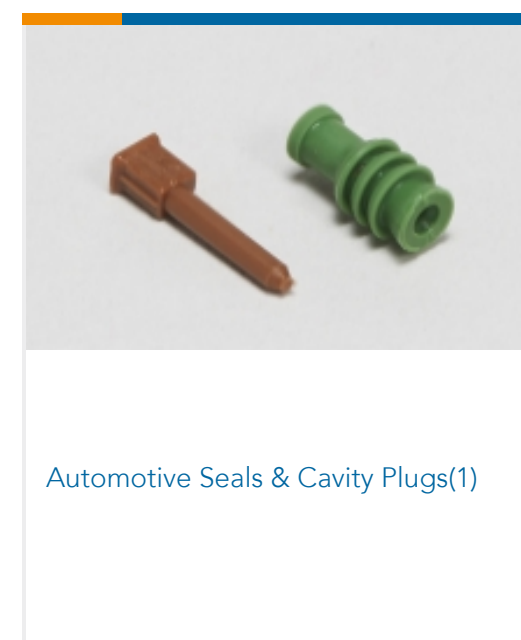
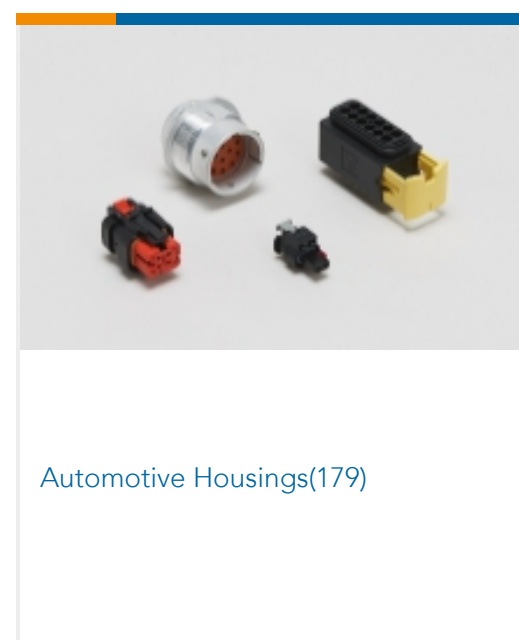
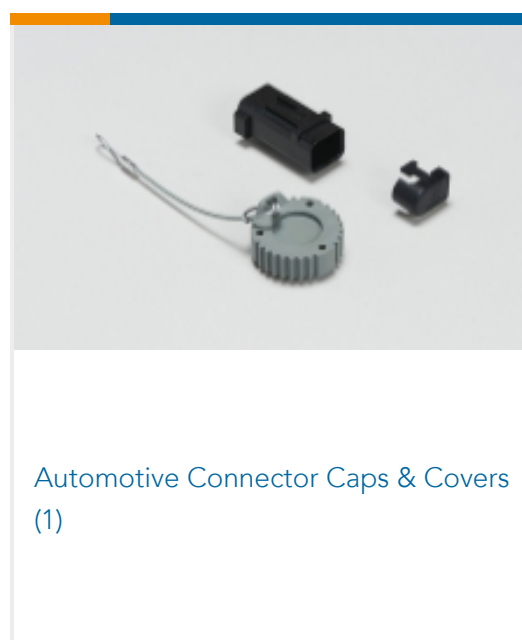

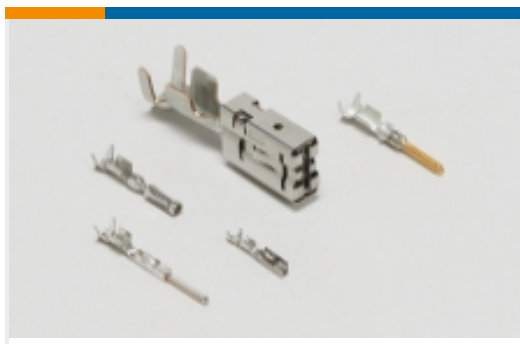

Automotive Terminals(6)



Insertion & Extraction Tools(6)

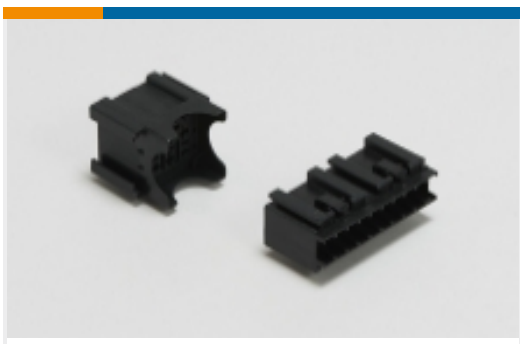

Module Components(1)

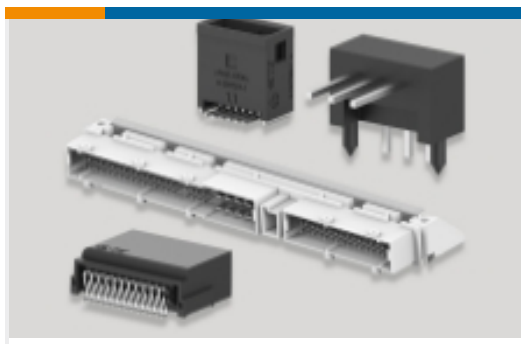

PCB Headers & Receptacles(1)

Also in the Series | AMP MCP Connector System



Automotive Connector Caps & Covers (24)

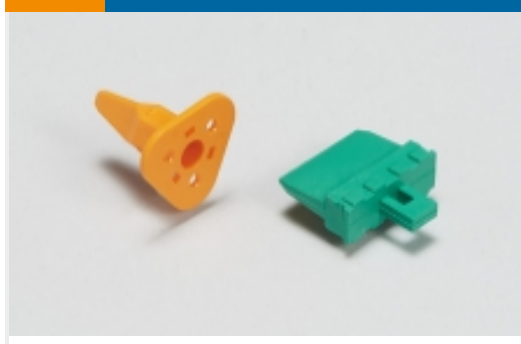

Automotive Connector Locks & Position Assurance(7)



Automotive Housings(352)



Automotive Seals & Cavity Plugs(6)



Automotive Terminals(125)



Insertion & Extraction Tools(13)



Other Automotive Connector Accessories(2)

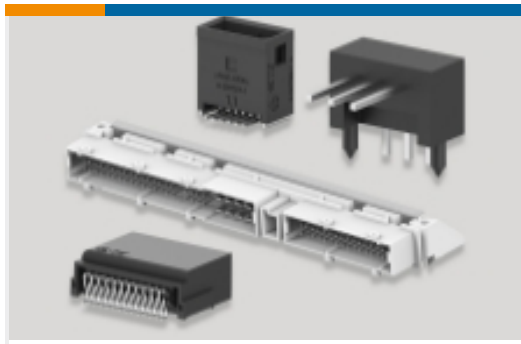

PCB Headers & Receptacles(29)

Customers Also Bought



TE Part #1241394-1
AMP MCP 2.8K, CONTACT, SWS



TE Part #1745032-1
2 POS. MCP2.8 CONNECTOR FOR
IGNITION KEY



TE Part #2236046-8
MCON, CONNECTOR HOUSING

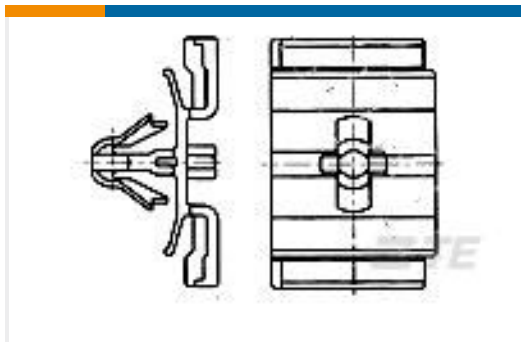

TE Part #282322-1
HOOK FOR SEALED SEC.CONN.

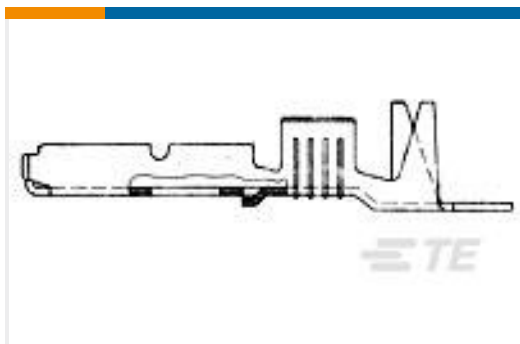

TE Part #281938-3
MIC MARKII RCPT CONTACT



TE Part #1-936059-3
2.8MM SLD 2P PLUG ASSY



TE Part #1-2344715-3
90POS, HYBRID, REC HSG ASSY, SLD,
COD A



TE Part #2328036-1
9POS, CHARGE INLET ASSY,
CHADEMO

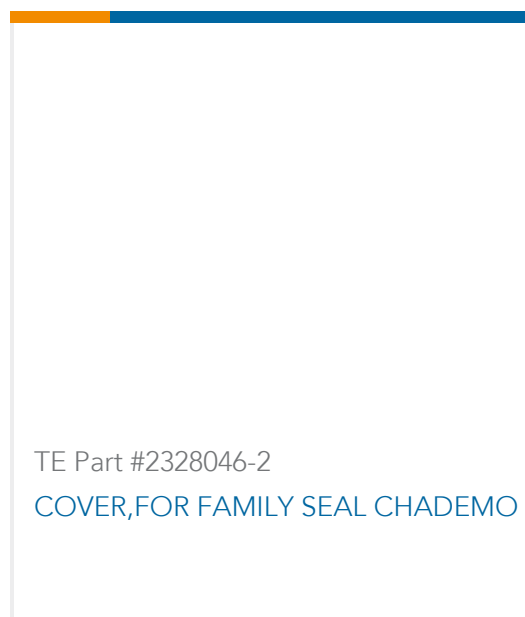

Documents

Product Drawings

[12 POS MCP HYBRID FEMALE CONN](#)

English

CAD Files

[3D PDF](#)

3D

Customer View Model

[ENG_CVM_CVM_284848-1_D.2d_dxf.zip](#)

English

Customer View Model

[ENG_CVM_CVM_284848-1_D.3d_igs.zip](#)

English

Customer View Model

[ENG_CVM_CVM_284848-1_D.3d_stp.zip](#)

English

By downloading the CAD file I accept and agree to the [Terms and Conditions](#) of use.

Product Specifications

[Application Specification](#)

English

Instruction Sheets

[Instruction Sheet \(non U.S.\)](#)

English