

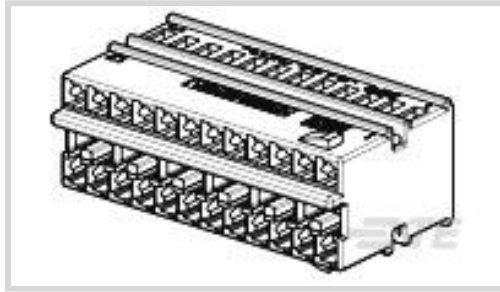

Connectors > Automotive Connectors > Connector Housings > MQS, CONNECTOR HOUSING



Connector & Housing Type: **Housing for Female Terminals**

Mating Tab Width: **.63 mm [.025 in]**

Connector System: **Wire-to-Wire**

Number of Positions: **24**

Centerline (Pitch): **2.54 mm [.1 in]**

[All MQS, CONNECTOR HOUSING \(557\)](#)

Features

Product Type Features

Connector & Housing Shape	Rectangular
Connector & Housing Type	Housing for Female Terminals
Connector System	Wire-to-Wire
Sealable	No
Hybrid Connector	No
Primary Locking Feature	On the Terminal

Configuration Features

Number of Positions	24
Number of Rows	2

Electrical Characteristics

Operating Voltage	24 VDC
Nominal Voltage Architecture	12 V, 24 V

Body Features

Cable Exit Angle	180°
Body Material	PA GF
Primary Product Color	Brown

Contact Features



Contact Size	.63mm
Contact Type	Receptacle
Mating Tab Width	.63 mm[.025 in]

Mechanical Attachment

Mounting Feature	Without
Terminal Position Assurance	No
Strain Relief	Without
Mating Alignment Type	Polarized
Mating Alignment	With
Connector Mounting Type	Cable Mount (Free-Hanging)

Housing Features

Centerline (Pitch)	2.54 mm[.1 in]
--------------------	----------------

Dimensions

Product Width	12.5 mm[.492 in]
Product Length	31.1 mm[1.224 in]
Product Height	16 mm[.63 in]
Row-to-Row Spacing	5.2 mm[.205 in]

Usage Conditions

Operating Temperature (Max)	70 °C, 75 °C, 80 °C, 85 °C, 90 °C, 100 °C, 105 °C[158 °F][167 °F][176 °F][185 °F][194 °F][212 °F][221 °F]
Operating Temperature Range	-30 – 105 °C[-22 – 221 °F]

Operation/Application

Circuit Application	Signal
---------------------	--------

Packaging Features

Packaging Method	Bag
------------------	-----

Other

Serviceable	No
Connector Position Assurance Capable	No

Product Compliance

[For compliance documentation, visit the product page on TE.com>](#)

EU RoHS Directive 2011/65/EU	Compliant
------------------------------	-----------



EU ELV Directive 2000/53/EC	Compliant
China RoHS 2 Directive MIIT Order No 32, 2016	No Restricted Materials Above Threshold
EU REACH Regulation (EC) No. 1907/2006	Current ECHA Candidate List: JAN 2022 (223) Candidate List Declared Against: JAN 2022 (223) Does not contain REACH SVHC
Halogen Content	Low Halogen - Br, Cl, F, I < 900 ppm per homogenous material. Also BFR/CFR/PVC Free
Solder Process Capability	Not applicable for solder process capability

Product Compliance Disclaimer

This information is provided based on reasonable inquiry of our suppliers and represents our current actual knowledge based on the information they provided. This information is subject to change. The part numbers that TE has identified as EU RoHS compliant have a maximum concentration of 0.1% by weight in homogenous materials for lead, hexavalent chromium, mercury, PBB, PBDE, DBP, BBP, DEHP, DIBP, and 0.01% for cadmium, or qualify for an exemption to these limits as defined in the Annexes of Directive 2011/65/EU (RoHS2). Finished electrical and electronic equipment products will be CE marked as required by Directive 2011/65/EU. Components may not be CE marked. Additionally, the part numbers that TE has identified as EU ELV compliant have a maximum concentration of 0.1% by weight in homogenous materials for lead, hexavalent chromium, and mercury, and 0.01% for cadmium, or qualify for an exemption to these limits as defined in the Annexes of Directive 2000/53/EC (ELV). Regarding the REACH Regulation, the information TE provides on SVHC in articles for this part number is based on the latest European Chemicals Agency (ECHA) 'Guidance on requirements for substances in articles' posted at this URL: <https://echa.europa.eu/guidance-documents/guidance-on-reach>

Compatible Parts



TE Part # 144969-2
MQS0,63 Au rec LL unseal. 0,2-0,6



TE Part # 953621-7
48pos MQS .63 header 90deg sld.



TE Part # 2209954-3
AIRBAG 24P COVER ASSY

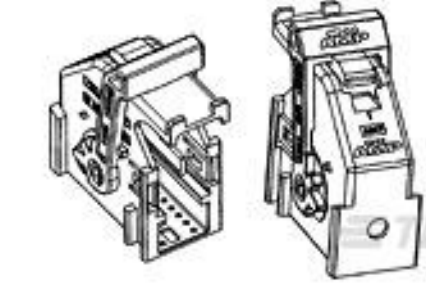

TE Part # 284714-3
24 POS AIRBAG CONN SHELL WITH

Also in the Series | MQS



Automotive Connector Caps & Covers (131)

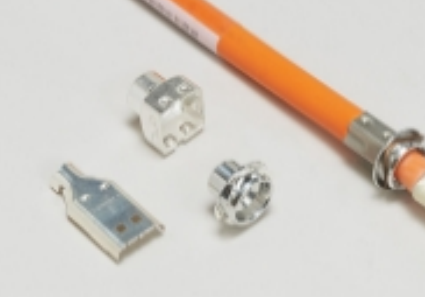

Automotive Connector EMC Shielding (2)

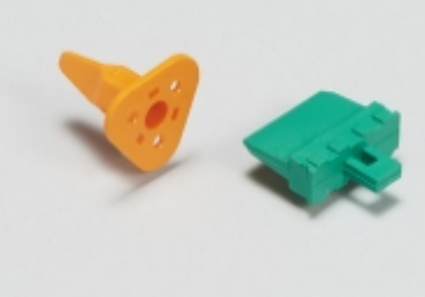

Automotive Connector Locks & Position Assurance(29)



Automotive Housings(489)



Automotive Seals & Cavity Plugs(26)

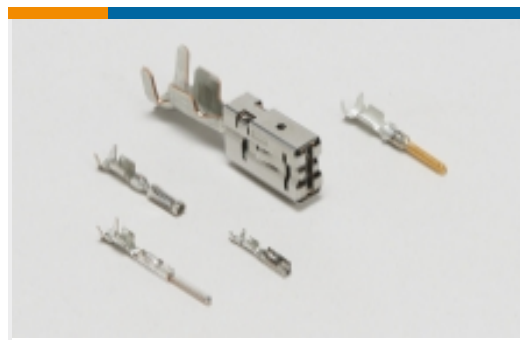

Automotive Terminals(96)



Insertion & Extraction Tools(42)



Other Automotive Connector Accessories(13)



PCB Headers & Receptacles(206)

Customers Also Bought



TE Part #2278584-1
MCON, CONNECTOR HOUSING

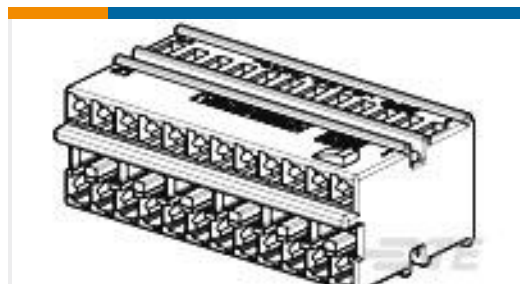

TE Part #284224-2
24 POS. REC. CONN. ASS' Y FOR AIR BAG



TE Part #936133-1
MULTILOCK, CONNECTOR HOUSING

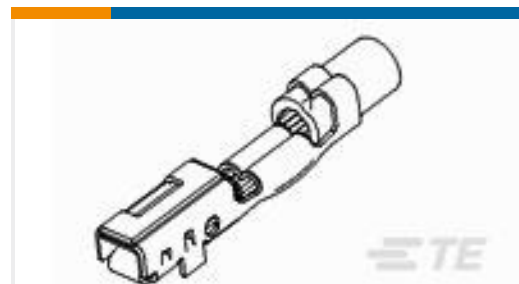

TE Part #1897598-1
090III MLC REC(LL) CONT

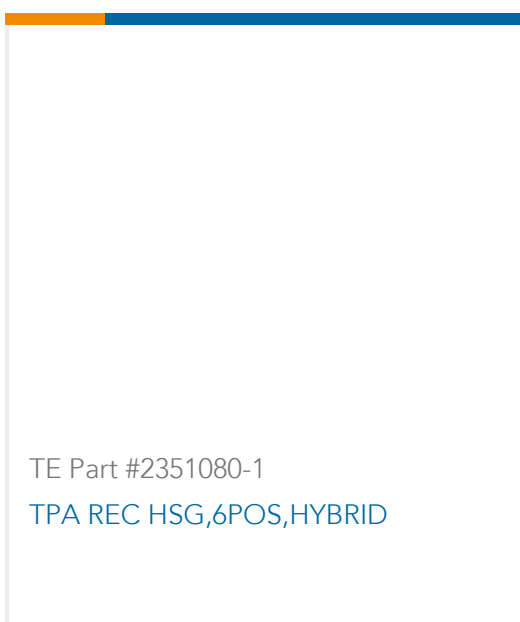

TE Part #2351080-1
TPA REC HSG,6POS,HYBRID

Documents

Product Drawings

[24 POS. REC. CONN. ASS' Y FOR AIR BAG](#)

CAD Files

[Customer View Model](#)

[ENG_CVM_CVM_284224-5_A.2d_dxf.zip](#)

English

[3D PDF](#)



3D

Customer View Model

[ENG_CVM_CVM_284224-5_A.3d_igs.zip](#)

English

Customer View Model

[ENG_CVM_CVM_284224-5_A.3d_stp.zip](#)

English

By downloading the CAD file I accept and agree to the [Terms and Conditions](#) of use.

Datasheets & Catalog Pages

[Micro Quadlok Interconnection System \(MQS\)](#)

English

Product Specifications

[Application Specification](#)

English