

368049-1 ✓ ACTIVE

Econoseal J - Mark II

TE Internal #: 368049-1

Automotive Connector Locks & Position Assurance, TPA (Terminal Position Assurance), Yellow, Wire-to-Wire / Wire-to-Board, PBT, Econoseal J - Mark II

[View on TE.com >](#)



Connectors > Automotive Connectors > Connector Accessories > Locks & Position Assurance

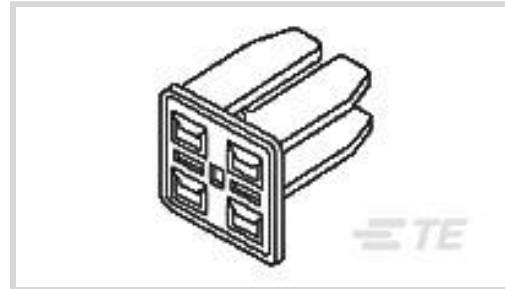

Connector & Contact Retention Accessory Type: **TPA (Terminal Position Assurance)**

Primary Product Color: **Yellow**

Connector System: **Wire-to-Board, Wire-to-Wire**

Primary Product Material: **PBT**

Operating Temperature Range: **-40 – 120 °C [-40 – 248 °F]**

Features

Product Type Features

Connector & Contact Retention Accessory Type	TPA (Terminal Position Assurance)
Connector System	Wire-to-Board, Wire-to-Wire

Body Features

Primary Product Color	Yellow
Primary Product Material	PBT

Usage Conditions

Operating Temperature Range	-40 – 120 °C[-40 – 248 °F]
-----------------------------	----------------------------

Industry Standards

UL Flammability Rating	UL 94HB
------------------------	---------

Packaging Features

Packaging Quantity	500
Packaging Method	Bag

Other

Serviceable	Yes
-------------	-----

Product Compliance

[For compliance documentation, visit the product page on TE.com>](#)



EU RoHS Directive 2011/65/EU	Compliant
EU ELV Directive 2000/53/EC	Compliant
China RoHS 2 Directive MIIT Order No 32, 2016	No Restricted Materials Above Threshold
EU REACH Regulation (EC) No. 1907/2006	Current ECHA Candidate List: JAN 2022 (223) Candidate List Declared Against: JAN 2022 (223) Does not contain REACH SVHC
Halogen Content	Not Low Halogen - contains Br or Cl > 900 ppm.
Solder Process Capability	Not applicable for solder process capability

Product Compliance Disclaimer

This information is provided based on reasonable inquiry of our suppliers and represents our current actual knowledge based on the information they provided. This information is subject to change. The part numbers that TE has identified as EU RoHS compliant have a maximum concentration of 0.1% by weight in homogenous materials for lead, hexavalent chromium, mercury, PBB, PBDE, DBP, BBP, DEHP, DIBP, and 0.01% for cadmium, or qualify for an exemption to these limits as defined in the Annexes of Directive 2011/65/EU (RoHS2). Finished electrical and electronic equipment products will be CE marked as required by Directive 2011/65/EU. Components may not be CE marked. Additionally, the part numbers that TE has identified as EU ELV compliant have a maximum concentration of 0.1% by weight in homogenous materials for lead, hexavalent chromium, and mercury, and 0.01% for cadmium, or qualify for an exemption to these limits as defined in the Annexes of Directive 2000/53/EC (ELV). Regarding the REACH Regulation, the information TE provides on SVHC in articles for this part number is based on the latest European Chemicals Agency (ECHA) 'Guidance on requirements for substances in articles' posted at this URL: <https://echa.europa.eu/guidance-documents/guidance-on-reach>

Compatible Parts



Also in the Series | Econoseal J - Mark II

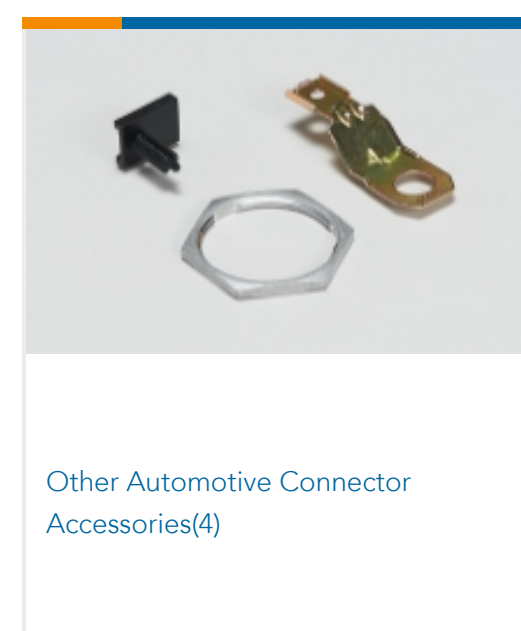
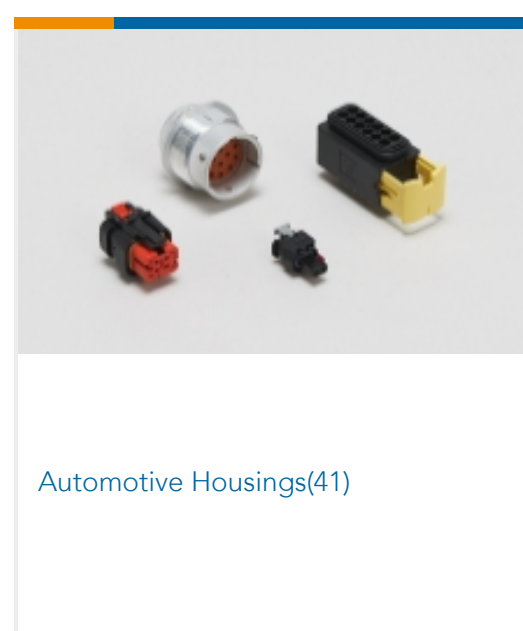

Customers Also Bought

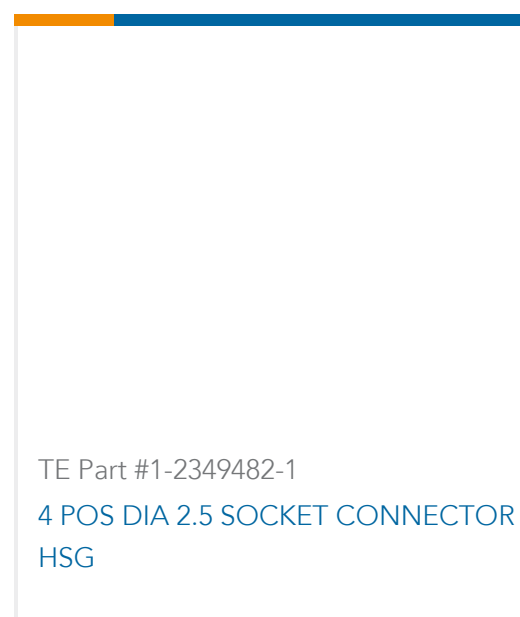
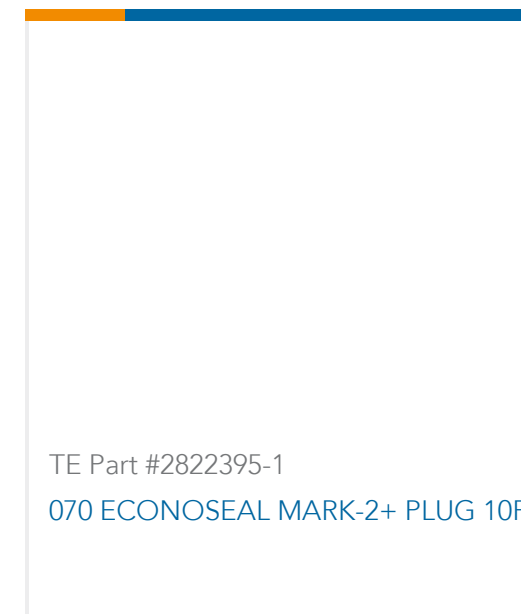
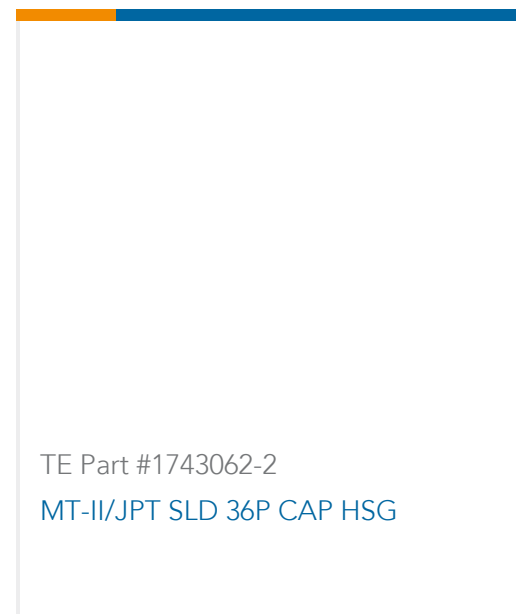
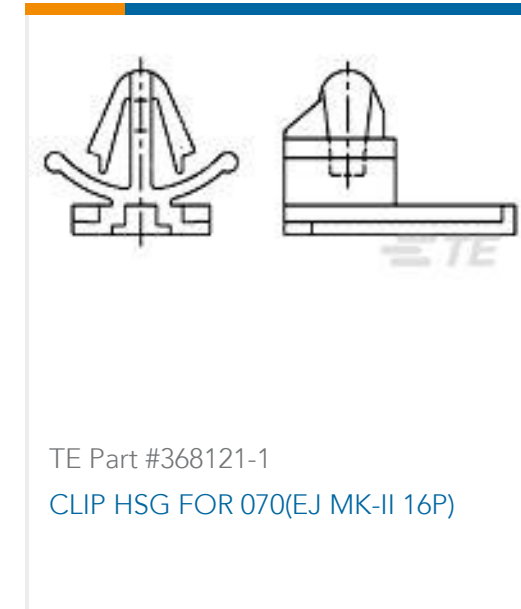

Documents

Product Drawings

E-J MK-II(+) 16P PLUG DBL

English

CAD Files

Customer View Model

[ENG_CVM_368049-1_A.3d_igs.zip](#)

English

Customer View Model

[ENG_CVM_368049-1_A.3d_stp.zip](#)

English

Customer View Model

[ENG_CVM_368049-1_A.2d_dxf.zip](#)

English

3D PDF

English

By downloading the CAD file I accept and agree to the [Terms and Conditions](#) of use.



Product Specifications

AMP-ECONOSEAL-J MARK II+ CONNECTOR

English

Product Specification

English

Product Environmental Compliance

Product Compliance

English

Product Compliance

English