

3-2177380-1 ✓ ACTIVE



IPT / APT

TE Internal #: 3-2177380-1

Ring Terminals & Spade Terminals, Ring Tongue, 8 – 0 AWG Wire Size, 8 – 50 mm<sup>2</sup> Wire Size, 10400 – 106000 CMA Wire Size, Stud Size None, IPT / APT

[View on TE.com >](#)

Terminals & Splices > Ring Terminals & Spade Terminals



Ring & Spade Terminal Type: **Ring Tongue**

Wire Size: **10400 – 106000 CMA**

Stud Size: **None**

## Features

### Product Type Features

Stud Size	None
Sealable	No
Compatible With Discrete Wire Type	Stranded
Wire Insulation Support Retention Type	Crimp Barrel

### Configuration Features

Terminal Angle	180 °
----------------	-------

### Contact Features

Ring & Spade Terminal Type	Ring Tongue
Barrel Type	Closed
Terminal Orientation	Straight
Terminal Plating Material	Tin

### Dimensions

Wire Size	10400 – 106000 CMA
Tongue Thickness	3.5 mm[.137 in]
Overall Product Length	46.8 mm[1.843 in]



Barrel Inside Diameter	10 mm[.393 in]
------------------------	----------------

### Usage Conditions

Operating Temperature Range	-40 – 140 °C[-40 – 284 °F]
-----------------------------	----------------------------

### Operation/Application

Heavy Duty	No
------------	----

### Packaging Features

Packaging Quantity	250
--------------------	-----

Packaging Method	Package
------------------	---------

### Product Compliance

[For compliance documentation, visit the product page on TE.com>](#)

EU RoHS Directive 2011/65/EU	Compliant
------------------------------	-----------

EU ELV Directive 2000/53/EC	Compliant
-----------------------------	-----------

China RoHS 2 Directive MIIT Order No 32, 2016	No Restricted Materials Above Threshold
---	---

EU REACH Regulation (EC) No. 1907/2006	Current ECHA Candidate List: JAN 2022 (223) Candidate List Declared Against: JAN 2022 (223) Does not contain REACH SVHC
--	---

Halogen Content	Low Halogen - Br, Cl, F, I < 900 ppm per homogenous material. Also BFR/CFR/PVC Free
-----------------	---















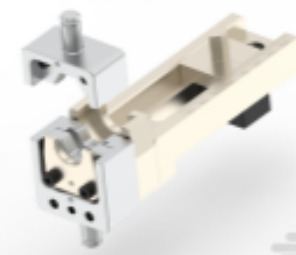

Solder Process Capability	Not reviewed for solder process capability
---------------------------	--

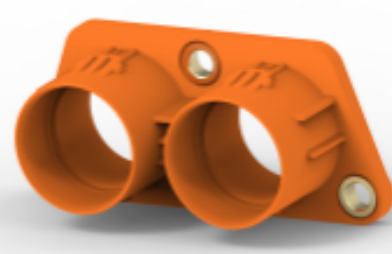
#### Product Compliance Disclaimer

This information is provided based on reasonable inquiry of our suppliers and represents our current actual knowledge based on the information they provided. This information is subject to change. The part numbers that TE has identified as EU RoHS compliant have a maximum concentration of 0.1% by weight in homogenous materials for lead, hexavalent chromium, mercury, PBB, PBDE, DBP, BBP, DEHP, DIBP, and 0.01% for cadmium, or qualify for an exemption to these limits as defined in the Annexes of Directive 2011/65/EU (RoHS2). Finished electrical and electronic equipment products will be CE marked as required by Directive 2011/65/EU. Components may not be CE marked. Additionally, the part numbers that TE has identified as EU ELV compliant have a maximum concentration of 0.1% by weight in homogenous materials for lead, hexavalent chromium, and mercury, and 0.01% for cadmium, or qualify for an exemption to these limits as defined in the Annexes of Directive 2000/53/EC (ELV). Regarding the REACH Regulation, the information TE provides on SVHC in articles for this part number is based on the latest European Chemicals Agency (ECHA) 'Guidance on requirements for substances in articles' posted at this URL: <https://echa.europa.eu/guidance-documents/guidance-on-reach>

### Compatible Parts

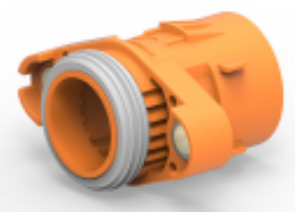
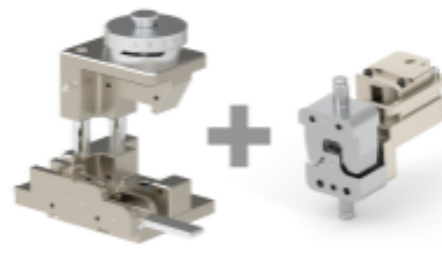
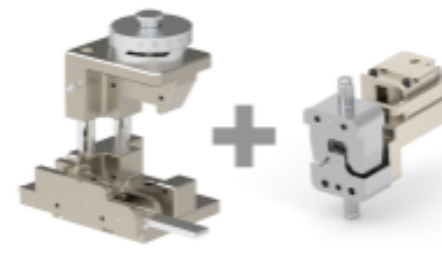

 <p>TE Part # 1-1991226-2 1 POS. RING TONGUE HOUSING ASSY. IPT 16-</p>	 <p>TE Part # 2141783-2 3POS,RING TONGUE,HSG,ASSY, SEALED</p>	 <p>TE Part # 2141784-2 2POS,RING TONGUE,HSG,ASSY, SEALED</p>	 <p>TE Part # 2-1991226-2 1 POS. RING TONGUE HOUSING ASSY. IPT 16-</p>
 <p>TE Part # 2355146-1 3POS,IPT,RING TONGUE HSG ASSY, SLD</p>	 <p>TE Part # 2355146-2 3POS,IPT,RING TONGUE HSG ASSY, SLD</p>	 <p>TE Part # 2359741-1 DIE SET IPT LV F 50MM2</p>	 <p>TE Part # 2371017-1 2POS,IPT,RING TONGUE HSG ASSY, SLD</p>
 <p>TE Part # 2371017-2 2POS,IPT,RING TONGUE HSG ASSY, SLD</p>	 <p>TE Part # 2371019-1 1POS,IPT,RING TONGUE HSG ASSY, SLD</p>	 <p>TE Part # 2371019-2 1POS,IPT,RING TONGUE HSG ASSY, SLD</p>	 <p>TE Part # 3-1991226-2 1 POS. RING TONGUE HOUSING ASSY. IPT 16-</p>
 <p>TE Part # 4-1991226-2 1 POS. RING TONGUE HOUSING ASSY. IPT 16-</p>	 <p>TE Part # 5-1991226-2 1 POS. RING TONGUE HOUSING ASSY. IPT 16-</p>	 <p>TE Part # 6-1991226-2 1 POS. RING TONGUE HOUSING ASSY. IPT 16-</p>	 <p>TE Part # 7-2359741-7 CRIMP TOOLING KIT</p>
 <p>TE Part # 7-2385672-7 CRIMP TOOLING KIT</p>	 <p>TE Part # 9-1991226-2 1 POS. RING TONGUE HOUSING ASSY. IPT 16-</p>	 <p><b>HV APPLICATOR</b> REPRESENTATION ONLY. DIE SET MAY VARY. TE Part # 9-2359741-1 APPLIC IPT-3P F 50MM2</p>	 <p><b>HV APPLICATOR</b> REPRESENTATION ONLY. DIE SET MAY VARY. TE Part # 9-2385672-1 HV DIE SET ASSEMBLY</p>

Also in the Series | [IPT / APT](#)



Automotive Connector Caps & Covers (9)



Automotive Connector EMC Shielding (8)



Automotive Housings(21)



Automotive Seals & Cavity Plugs(7)



High Voltage Wire Processing Equipment(17)



Other Automotive Connector Accessories(21)



Ring Terminals & Spade Terminals(11)

## Customers Also Bought

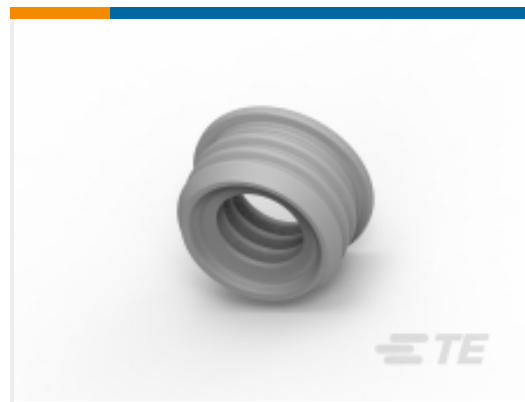

TE Part #1719826-7  
SINGLE WIRE SEAL,8MM HV



TE Part #1-1991225-7  
PROTECTIVE COVER. IPT 16-50mm sq.  
CABLE D



TE Part #2141783-2  
3POS,RING TONGUE,HSG,ASSY,  
SEALED



TE Part #2141784-2  
2POS,RING TONGUE,HSG,ASSY,  
SEALED



TE Part #2141809-3  
CONTACT KIT, BODY AND SPRING,



TE Part #1-2141166-1  
3POS,8MM HV,REC HSG,90DEG,ASSY,  
SEALED



TE Part #2141608-4  
5POS,AMP MCP6.3/4.8K,REC HSG,A



TE Part #2141630-1  
5POS,HVA630,REC HSG ASSY,  
180DEG,HVIL

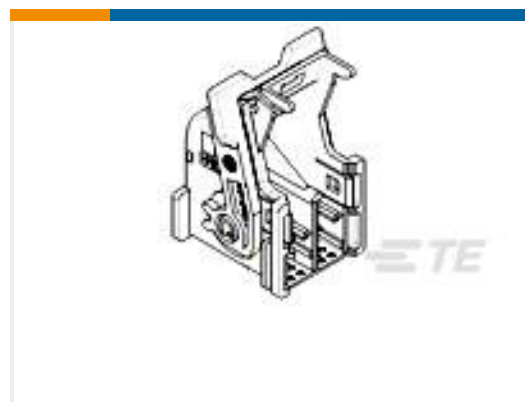

TE Part #953122-5  
COVER ASSY 40 W MQS



TE Part #206247P044  
SCT-NO.4-E2-0-30MM

## Documents



## Product Drawings

### RING TONGUE, CONTACT

English

---

## CAD Files

### 3D PDF

3D

#### Customer View Model

[ENG\\_CVM\\_CVM\\_3-2177380-1\\_B.2d\\_dxf.zip](#)

English

#### Customer View Model

[ENG\\_CVM\\_CVM\\_3-2177380-1\\_B.3d\\_igs.zip](#)

English

#### Customer View Model

[ENG\\_CVM\\_CVM\\_3-2177380-1\\_B.3d\\_stp.zip](#)

English

By downloading the CAD file I accept and agree to the [Terms and Conditions](#) of use.

---

## Datasheets & Catalog Pages

### HEMS Product Overview

English

---

## Product Specifications

### Application Specification

English